

# Industrial pressure controller Model CPC4000



WIKA data sheet CT 27.40

## Applications

- Oil and gas industry
- Industry (laboratory, workshop and production)
- Transmitter and pressure gauge manufacturers
- Calibration service companies and service industry

## Special features

- Pressure ranges: -1 ... 210 bar (-15 ... 3,045 psi)
- Control speed 10 s
- Control stability < 0.005% FS
- Accuracy down to 0.02% IS (IntelliScale)
- Precision 0.008% FS

## Description

### Design

The model CPC4000 industrial pressure controller offers a broad pressure range from -1 ... 210 bar (-15 ... 3,045 psi). This instrument is available as a desktop or as a 19" rack-mounting kit. It can have up to two reference pressure transducers and an optional barometer for displaying barometric pressure or can be used to emulate gauge or absolute pressure.

### Application

Since the controller offers an accuracy of up to 0.02 % IS-50, and controls pressure with a high stability, it is particularly suited as a production tool for transmitter manufacturing, a calibration and maintenance tool for pressure measuring instruments or as a factory/working standard for the calibration of all types of pressure measuring instruments. The leak test and burst test applications allow CPC4000 to be used as a pressure line testing equipment. The optional automatic contamination prevention system makes the CPC4000 an ideal solution in oil and gas plants.

### Functionality

Maximum ease-of-use is achieved through the touchscreen and the simple and intuitive menu navigation. In addition, the large number of menu languages add to its operability. The instrument can have up to two internal pressure transducers and the ranges for each reference pressure transducer are determined by the customer within the allowable range.



Industrial pressure controller, model CPC4000

Depending on the application, the operator can choose between three set-point entry methods:

- 1) Direct entry of the pressure value (set point) which will be controlled via touchscreen keypad.
- 2) Define steps to reach the desired pressure value by either defining fixed pressure increments or a percentage of span value.
- 3) User-defined programmable test sequences.

### Software

The WIKA-CAL calibration software enables the convenient calibration of pressure measuring instruments and the generation of test certificates. Additionally, the instrument can also be remotely controlled using either the Mensor standard, SCPI or other optional command sets.

### Complete test and calibration systems

On request, complete mobile or stationary test systems can be manufactured. There is an IEEE-488.2, RS-232, USB and an Ethernet interface for communication with other instruments, and thus the instrument can be integrated into existing systems.

# Specifications

## Model CPC4000

Reference pressure transducers model CPR4000		
Pressure range	Standard	Optional
Accuracy <sup>1)</sup>	0.02% FS <sup>2)</sup>	0.02% IS-50 <sup>3)</sup>
Gauge pressure	0 ... 0.35 to 0 ... 210 bar (0 ... 5 to 0 ... 3,045 psi) <sup>4)</sup>	0 ... 1 to 0 ... 210 bar (0 ... 15 to 0 ... 3,045 psi) <sup>4)</sup>
Bi-directional	-0.17 ... 0.17 to -1 ... 210 bar (-2.5 ... 2.5 to -15 ... 3,045 psi) <sup>4)</sup>	-1 ... 10 to -1 ... 210 bar (-15 ... 145 to -15 ... 3,045 psi) <sup>4)</sup>
Absolute pressure <sup>5)</sup>	0 ... 1 to 0 ... 211 bar abs. (0 ... 15 to 0 ... 3,060 psi abs.)	0 ... 1 to 0 ... 211 bar abs. (0 ... 15 to 0 ... 3,060 psi abs.)
Precision <sup>6)</sup>	0.008% FS	0.008% FS
Calibration interval	365 days	365 days
Optional barometric reference		
Function	The barometric reference can be used to switch pressure types <sup>7)</sup> , absolute <=> gauge. With gauge pressure transducers, the measuring range of the transducers must begin with -1 bar (-15 psi) in order to carry out a complete absolute pressure emulation.	
Measuring range	552 ... 1,172 mbar abs. (8 ... 17 psi abs.)	
Accuracy <sup>1)</sup>	0.02% of reading	
Pressure units	39 and two freely programmable	

1) It is defined by the total measurement uncertainty, with the coverage factor (k = 2) and includes the intrinsic performance of the instrument, the measurement uncertainty of the reference instrument, long-term stability, influence of ambient conditions, drift and temperature effects over the compensated range with recommended zero point adjustment every 30 days.

2) FS = full span

3) 0.02% IS-50 accuracy: Between 0 ... 50% of the full scale, the accuracy is 0.02% of half of the full scale value and between 50 ... 100% of the full scale, the accuracy is 0.02% of reading.

4) Ranges from 1500 to 2000 psig will be sealed gauge transducers

5) The minimum calibrated range of absolute transducer(s) is 600mTorr

6) It is defined as the combined effects of linearity, repeatability and hysteresis throughout the stated compensated temperature range

7) For a pressure type emulation, we recommend a native absolute pressure transducer, since the zero point drift can be eliminated through a zero point adjustment.

Base instrument	
Instrument	
Instrument version	Standard: desktop case Option: 19" rack-mounting kit
Dimensions	See technical drawings
Weight	approx. 12.7 kg (28 lbs) incl. all internal options
Warm-up time	approx. 15 min
Display	
Screen	7.0" color LCD with resistive touchscreen
Resolution	4 ... 6 digits depending on range and units
Connections	
Pressure connections	4 ports with 7/16"- 20 F SAE, 1 port with 1/8" F NPT and 1 port with 10-32 UNF female
Filter elements	The instrument has a 40-micron filters on all pressure ports.
Pressure port adapters	Standard: without Option: 6 mm tube fitting, 1/4" tube fitting, 1/4" female NPT fittings, 1/8" female NPT fittings or 1/8" female BSP fittings
Barometer port adapters	Standard: barb fitting Option: 6mm tube fitting, 1/4" tube fitting
Permissible pressure media	Dry, clean air or nitrogen (ISO 8573-1:2010 class 5.5.4 or better)
Wetted parts	Aluminum, brass, 316 and 316L stainless steel, Buna N, FKM/FPM, PCTFE, PEEK, PTFE, PPS, glass-filled epoxy, RTV, ceramic, silicone, silicone grease, Urethane
Overpressure protection	Safety relief valve fixed to reference pressure transducer and adjusted to specific measuring range
Permissible pressure	
Supply port	110% FS or 0.69 bar (10 psi), whichever is greater
Measure/Control port	max. 105 % FS
Voltage supply	
Power supply	AC 100 ... 120 V, 50/60 Hz; AC 220 ... 240 V, 50/60 Hz
Power consumption	max. 150 VA
Permissible ambient conditions	
Storage temperature	-20 ... 70 °C (-4 ... 158 °F)

Base instrument	
Humidity	5 ... 95% r. h. (relative humidity non-condensing)
Compensated temperature range	15 ... 45 °C (59 ... 113 °F)
Mounting position	horizontal
Control parameter	
Control stability	< 0.005% FS of the primary range in precision mode
Control mode	precision, high speed and custom
Control time	10 s (regarding a 10% FS pressure increase above atm. in a 50 ml test volume, in high speed mode)
Control range	0 ... 100% FS
Minimum control pressure	0.0017 bar (0.025 psi) over exhaust pressure or 0.05% FS whichever is greater
Overshoots	< 1% FS in high speed control mode (typical <0.1% FS in precision control mode)
Test volume	50 ... 1,000 ccm
Communication	
Interface	Standard: Ethernet, IEEE-488, USB, RS-232.
Command sets	Mensor, WIKA SCPI, others optional
Response time	approx. 100 ms
Internal program	up to 24 sequences with up to 99 steps each

Approvals and certificates	
EC declaration of conformity	
EMC directive <sup>8)</sup>	EN 61326-1 emission (group 1, class A) and interference immunity (industrial application)
Low voltage directive	EN 61010-1
RoHS directive	2011/65/EU, article 4
Certificate	
Calibration <sup>9)</sup>	Standard: A2LA calibration certificate (standard on factory) Option: DKD/DAkKS calibration certificate

- 8) **Warning!** This is class A equipment for emissions and is intended for use in industrial environments. In other environments, e.g. residential or commercial installations, it can interfere with other equipment under certain conditions. In such circumstances the operator is expected to take the appropriate measures.
- 9) Calibration in a horizontal position/operating position.

Approvals and certificates, see website

### Working ranges of the controller modules

#### Bi-directional or gauge pressure [bar (psi)] <sup>1)</sup>

-1 (-15)	0	3.4 (50)	10 (150)	100 (1,500)	210 (3,045)
LPSVR MODULE ±0.17 bar (±2.5 psi) <sup>2)</sup>					
MPSVR MODULE ±0.35 bar (±5 psi) <sup>2)</sup>					
HPSVR MODULE -1 ... 5 bar (-15 ... +75 psi) <sup>2)</sup>					
EPSVR MODULE -1 ... 10 bar (-15 ... +150 psi) <sup>2)</sup>					

#### Absolute pressure [bar (psi)] <sup>1)</sup>

0	4.4 (65)	11 (165)	101 (1,515)	211 (3,060)
LPSVR MODULE 0 ... 1 bar (0 ... 15 psi) <sup>2)</sup>				
MPSVR MODULE 0 ... 1 bar (0 ... 15 psi) <sup>2)</sup>				
HPSVR MODULE 0 ... 6 bar (0 ... 90 psi) <sup>2)</sup>				
EPSVR MODULE 0 ... 11 bar (0 ... 165 psi) <sup>2)</sup>				

- 1) Mixing of absolute pressure and gauge pressure transducers in a module is not possible.
- 2) Smallest acceptable transducer range

For controlling absolute pressure a vacuum pump connected at the exhaust port is required.

## Touchscreen and intuitive operator interface

Shortly after power-up, the standard main screen (see following picture) is displayed. In this menu screen, one can switch between the operating modes using the buttons **MEASURE** (11), **CONTROL** (10) and **VENT** (9). The instrument is a precision pressure controller, whose setup (incl. optional functions) can be easily configured via the touchscreen.

### Standard desktop/main screen



① Home application

② General settings

③ Control settings

④ Display settings

⑤ Programs

⑥ Favorites

⑦ Barometric pressure reading (optional)

⑧ Menu scroll features forward / back

⑨ **VENT**

Immediately vents the system, including the test assembly connected to the Measure/Control port, to atmosphere.

⑩ **CONTROL**

In control mode the instrument provides a highly accurate pressure at the Measure/Control port of the respective channel in accordance with the desired set point.

⑪ **MEASURE**

In measure mode, the pressure present at the Measure/Control port is measured with high accuracy (if you switch directly from **CONTROL** to **MEASURE** mode, the last controlled pressure in the connected test assembly will be maintained/locked).

⑫ Auxiliary displays either peak, rate or alternate units

⑬ Current pressure unit and type

⑭ Optional bar graph

⑮ Current measuring value

⑯ Zero or Tare function

⑰ Entered set point

⑱ Pressure range of the transducers

⑲ Selection of the active transducer or auto-range

⑳ Current application name

# Automatic Contamination Prevention System (A-CPS)

## Active decontamination

The Automatic Contamination Prevention System or A-CPS is an accessory to the CPC4000 Industrial Pressure Controller that prevents particle, water or oil contaminants from entering the instrument through the device under test. The A-CPS uses a coalescing filter and an automatically actuated bleed valve to remove all the contaminants and stores them in a transparent sump bottle for easy cleanup.

The A-CPS allows hassle free operation between the device under test and the CPC4000 by reducing the additional process of deep cleaning the device prior to calibration. The A-CPS does not require an additional power source because it is driven completely by the pressure controller itself.

The A-CPS also acts like a test gauge stand for easy mounting and setup of the device under test. This reduces the requirement of additional manifolds & setup.



## A-CPS Specifications

### Operating Conditions

Maximum operating pressure	3,065 psig (211 bar gauge)
Maximum operating temperature	80 °C (176 F)

### Voltage Supply

Power supply	12 VDC
Power consumption	13 VA

### Pressure Connection

To the M/C port of CPC6050	1 port with 1/4" tube adapted to 7/16"- 20 F SAE
To the DUT	2 ports with Standard: 7/16" - 20 F SAE Option: 6 mm tube fitting, 1/4" tube fitting, 1/4" female NPT fittings, 1/8" female NPT fittings or 1/8" female BSP fittings

### Dimensions & Weight

Dimensions	5.5 in x 10.5 in x 5.5 in (W x H x D)
Weight	3.9 kgs (8.8 lbs.)

## Automatic or manual purging with CPC4000

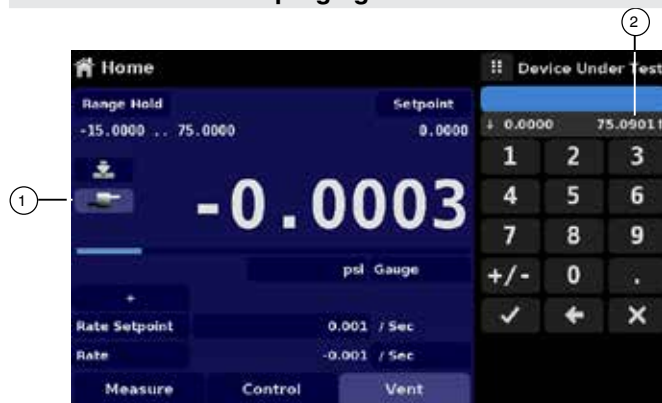

- ① Purge button
- ② Max purge pressure limit

The Automatic Contamination System can be driven seamlessly with the CPC4000 in Manual or Auto mode. The Auto mode will engage the Purge sequence every time the controller switches from Vent to Control mode.

The Manual mode provides an option for pre-cleansing the system by purging the device under test several times. A Purge button appears on the instrument's Home screen when the A-CPS is activated. The Purge button enables setting the desired maximum pressure for decontaminating the device under test prior to normal operation with the Industrial Pressure Controller, CPC4000.

## Dimensions in mm (in)

### Desktop case

#### Front view

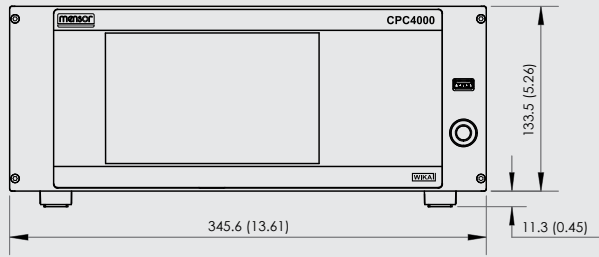

#### Side view (left)

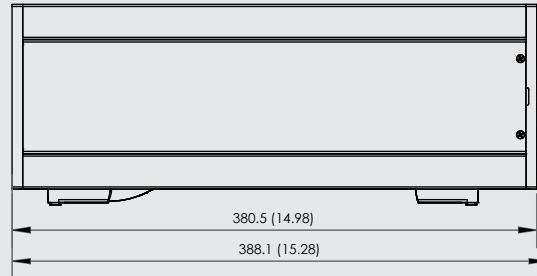

### 19" rack-mounting kit, front view

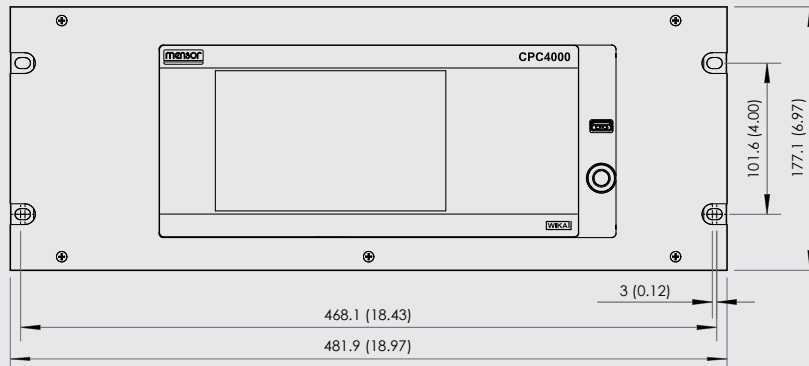

## Electrical and pressure connections - rear view

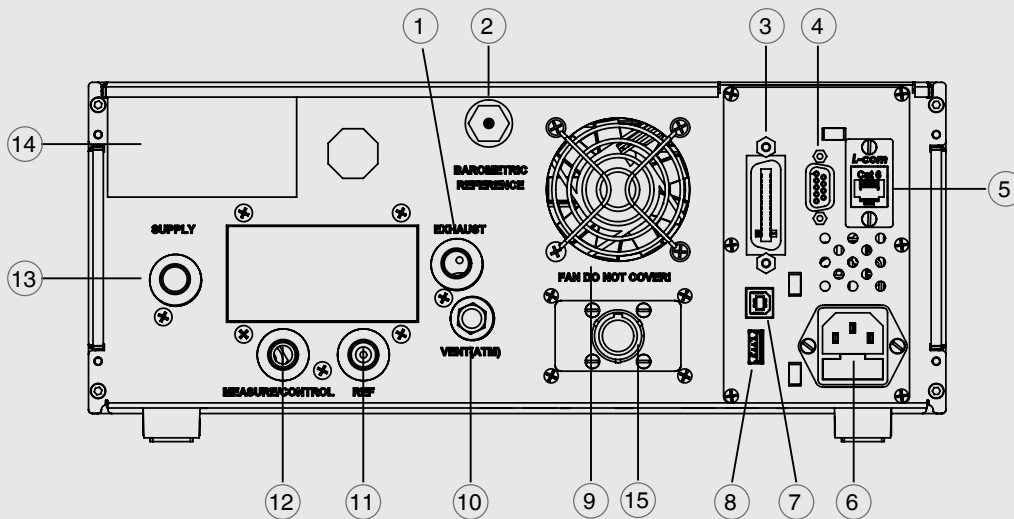

- |   |                                      |
|---|--------------------------------------|
| ① Exhaust port (7/16-20 UNF)                          | ⑨ Fan                                |
| ② Barometric reference port (10-32 UNF)               | ⑩ Vent (ATM)                         |
| ③ IEEE-488 interface                                  | ⑪ Reference port (7/16-20 UNF)       |
| ④ RS-232 interface                                    | ⑫ Measure/Control port (7/16-20 UNF) |
| ⑤ Ethernet port                                       | ⑬ Supply port (7/16-20 UNF)          |
| ⑥ Power supply  | ⑭ Instrument label                   |
| ⑦ USB interface (instrument) for remote communication | ⑮ Automatic CPS connector            |
| ⑧ USB interface (host) for service                    |                                      |

## WIKA-CAL calibration software

### Easy and fast creation of a high-quality calibration certificate

The WIKA-CAL calibration software is used for generating calibration certificates or logger protocols for pressure measuring instruments and is available as a demo version for a cost-free download.

A template helps the user and guides him through the creation process of a document.

In order to switch from the demo version to a full version of the respective template, a USB key with the template has to be purchased.

The pre-installed demo version automatically changes to the selected full version when the USB key is inserted and is available as long as the USB key is connected to the computer.



- Creation of calibration certificates for mechanical and electronic pressure measuring instruments
- Fully automatic calibration with pressure controllers
- Calibration of gauge pressure measuring instruments with absolute pressure references and vice versa
- A calibration assistant guides you through the calibration
- Automatic generation of the calibration steps
- Generation of 3.1 certificates per DIN EN 10204
- Creation of logger protocols
- User-friendly interface
- Languages: German, English, Italian and more due with software updates

For further information see data sheet CT 95.10

Calibration certificates can be created with the Cal-Template and logger protocols can be created with the Log-Template.



#### Cal Demo

Generation of calibration certificates limited to 2 measuring points, with automatic initiation of pressures via a pressure controller.



#### Cal Light

Generation of calibration certificates with no limitations on measuring points, without automatic initiation of pressures via a pressure controller.



#### Cal

Generation of calibration certificates with no limitations on measuring points, with automatic initiation of pressures via a pressure controller.



#### Log Demo

Creation of data logger test reports, limited to 5 measured values.



#### Log

Creation of data logger test reports without limiting the measured values.

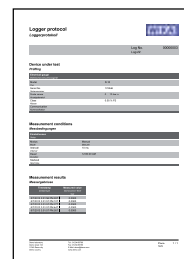
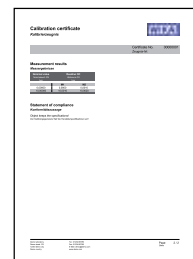
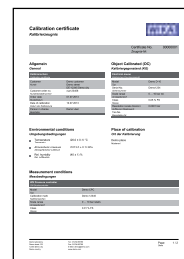

## Scope of delivery

- Industrial pressure controller model CPC4000 (desktop case)
- 1.5 m (5 ft) power cord
- Operating instructions
- A2LA calibration certificate (standard on factory)

## Accessories

- Pressure adapters
- Interface cable
- Coalescing filter
- Block and bleed valve
- Pressure booster
- WIKA-CAL calibration software

## Options

- DKD/DAkkS calibration certificate
- Second reference pressure transducer model CPR4000
- Barometric reference
- 19" rack-mounting kit
- Customer-specific system
- Adapters and fittings for pressure connections
- Automatic contamination prevention system
- DPI5xx remote command set
- PACE remote command set

## Ordering information

Model / Case / Pressure range base instrument / Pressure unit / Pressure type / Minimum pressure range / Maximum pressure range / Accuracy / Type of calibration certificate / Barometric reference / Type of certificate for barometric reference / Digital interface / Pressure port adapters / Power cord / Additional ordering information

© 2015 WIKA Alexander Wiegand SE & Co. KG, all rights reserved.  
The specifications given in this document represent the state of engineering at the time of publishing.  
We reserve the right to make modifications to the specifications and materials.



**Mensor**  
201 Barnes Drive  
San Marcos, TX 78666  
Tel. (512) 396-4200  
Fax (512) 396-1820  
sales@mensor.com  
www.mensor.com