

High-speed pneumatic pressure controller Model CPC3000



WIKA data sheet CT 27.55



Applications

- Industry (laboratory, workshop and production)
- Transmitter and pressure gauge manufacturers
- Calibration service companies and service industry
- Research and development laboratories

Special features

- Pressure ranges -1 ... 100 bar / -1 ... 1,500 psi
- Control speed < 3 s
- Control stability 0.004 % FS
- Precision up to 0.015 % IS (IntelliScale)
- Accuracy up to 0.025 % IS (IntelliScale)



High-speed pneumatic pressure controller,
model CPC3000

Description

Design

With its compact design, its exceptionally reliable and patented control unit, and available pressure ranges of -1 ... 100 bar / -1 ... 1,500 psi, the model CPC3000 high-speed pneumatic pressure controller offers a wide range of application possibilities. The instrument is available as a desktop instrument or as a 19" rack-mounted unit.

Application

Since the controller offers an accuracy of up to 0.025 % IS-50, and the pressure can be controlled extremely quickly, it is particularly suited as a production tool for gauge and/or transmitter manufacturing or as a factory/working standard for the verification or calibration of all types of pressure measuring instrument.

Functionality

The large touchscreen and the simple menu navigation guarantee maximum ease-of-use. In addition, its operability is further supported by the availability of a large number of menu languages.

Depending on the application, the operator can choose between three input functions or menu blocks:

- 1) Numeric keypad for the precise input of the pressure value (set point) which will be controlled.

- 2) STEP button block (max. 12). Each button thus represents a defined pressure value (these pressure steps are freely definable via the menu).
- 3) JOG buttons: with these, the three least significant decimal places of the current pressure value can be raised or lowered by a digit.

Software

In addition to the WIKA-CAL calibration software, which enables the convenient calibration of pressure measuring instruments and the generation of test certificates, individual test programmes can also be created, e.g. within LabVIEW®. For the serial command formats, the Mensor standard, SCPI or further optional instruction sets are available.

Complete test and calibration systems

On request, complete mobile or stationary test systems can be manufactured. There is an IEEE-488.2, RS-232 or USB and an Ethernet interface for communication with other instruments, and thus the instrument can be integrated into existing systems.

**Specifications
CPC3000****Reference pressure sensors**

Pressure range	Standard	Optional
Accuracy ¹⁾	0.025 % FS	0.025 % IS-50 ³⁾
Gauge pressure	0 ... 0.35 up to 0 ... 100 bar 0 ... 5 up to 0 ... 1,500 psi	0 ... 1 up to 0 ... 100 bar 0 ... 15 up to 0 ... 1,500 psi
Bi-directional	-0.35 ... +0.35 up to -1 ... +100 bar -5 ... +5 up to -15 ... 1,500 psi	-1 ... 10 up to -1 ... 100 bar -15 ... 150 up to -15 ... 1,500 psi
Absolute pressure	0 ... 1 up to 0 ... 101 bar abs. 0 ... 15. up to 0 ... 1,515 psi abs.	0 ... 1 up to 0 ... 101 bar abs. 0 ... 15 up to 0 ... 1,515 psi abs.
Precision ²⁾	0.015 % FS	0.015 % IS

Optional barometric reference

Function	The barometric reference can be used to switch pressure types ⁴⁾ , absolute <=> gauge. With gauge pressure sensors, the measuring range of the sensors must begin with -1 bar / -15 psi in order to carry out an absolute pressure emulation.
Measuring range	552 ... 1,172 mbar abs. / 8 ... 17 psi abs.
Accuracy ²⁾	0.02 % of reading
Pressure units	38 and 2 freely programmable

- 1) It is defined by the total measurement uncertainty, which is expressed with the coverage factor (k=2) and includes the following factors: the intrinsic performance of the instrument, the measurement uncertainty of the reference instrument, long-term stability, influence of ambient conditions, drift and temperature effects over the compensated range during a periodic zero point adjustment.
- 2) It is defined as the maximum deviation between two measurements at one point under laboratory conditions which includes linearity, hysteresis and repeatability of the measuring instrument.
- 3) 0.025 % IS-50 accuracy: 0.025 % of reading in the upper half of the measuring range.
- 4) For a pressure type emulation, we recommend a native absolute pressure sensor, since the zero point drift can be eliminated through a zero point adjustment.

Base instrument

Instrument	
Instrument version	Standard: desktop case with bezel and handle Option: 19" mounting with side panels
Dimensions in mm	see technical drawings
Weight	approx. 9.1 kg / approx. 20 lb
Display	
Screen	7.0" colour LCD with touchscreen
Resolution	4 ... 6 digits
Display update	4 values/s
Warm-up time	approx. 15 min
Connections	
Pressure connections	4 ports with 7/16"- 20 F SAE
Filter elements	Filter element (40 micron) included in each pressure port
Pressure port adapters	Standard: without Option: 6 mm Swagelok® threaded pipe connection, 1/4" Swagelok® threaded pipe connection, 1/4" NPT female, 1/8" NPT female or 1/8" BSPG female
Permissible pressure media	dry, clean air or nitrogen
Wetted parts	aluminium, brass, 316 and 316L stainless steel, Buna N, FKM/FPM, glass-filled epoxy, RTV, nylon, ceramic
Overpressure protection	Safety relief valve adjusted to customised pressure range
Permissible pressure	
Supply Port	~ 110 % FS
Measure/Control Port	max. 105 % FS

Base instrument

Power supply

Power supply AC 100 ... 240 V, 50 Hz

Power consumption max. 90 VA

Permissible ambient conditions

Storage temperature 0 ... 70 °C / 32 ... 158 °F

Humidity 0 ... 95 % r. h. (relative humidity, non-condensing)

Compensated temperature range 15 ... 45 °C / 59 ... 113 °F

Mounting position horizontal or slightly tilted

Control parameter

Control stability < 0.004 % FS

Control time < 3 s (with a sudden pressure increase of 10 % FS in a 150 ml test volume)

Control range 0 ... 100 % FS

Overshoots < 1 % FS in high speed mode

Test volume 50 ... 1,000 ccm (without throttle)

Communication

Interface Ethernet, IEEE-488, USB or RS-232

Command sets Mensor, WIKA SCPI, others optional

Response time approx. 100 ms

Approvals and certificates

CE conformity

EMC directive ⁵⁾ 2004/108/EC, EN 61326 emission (group 1, class B) and interference immunity (industrial application)

Low voltage directive 2006/95/EC, EN 61010-1

Approvals

GOST Metrology/measuring technology, Russia

Certificate

Calibration ⁶⁾ Standard: 3.1 calibration certificate per EN 10204
Option: DKD/DakkS calibration certificate

5) **Warning!** This is class A equipment for emissions and is intended for use in industrial environments. In other environments, e.g. residential or commercial installations, it can interfere with other equipment under certain conditions. In such circumstances the operator is expected to take the appropriate measures.

6) Calibration in a horizontal position.

Approvals and certificates, see website

Easy operation via touchscreen

Standard desktop / main screen

Shortly after power-up, the standard desktop (see following picture) displays. In this menu screen, one can switch between the operating modes using the buttons "MEASURE" / "CONTROL" / "VENT" (bottom left).

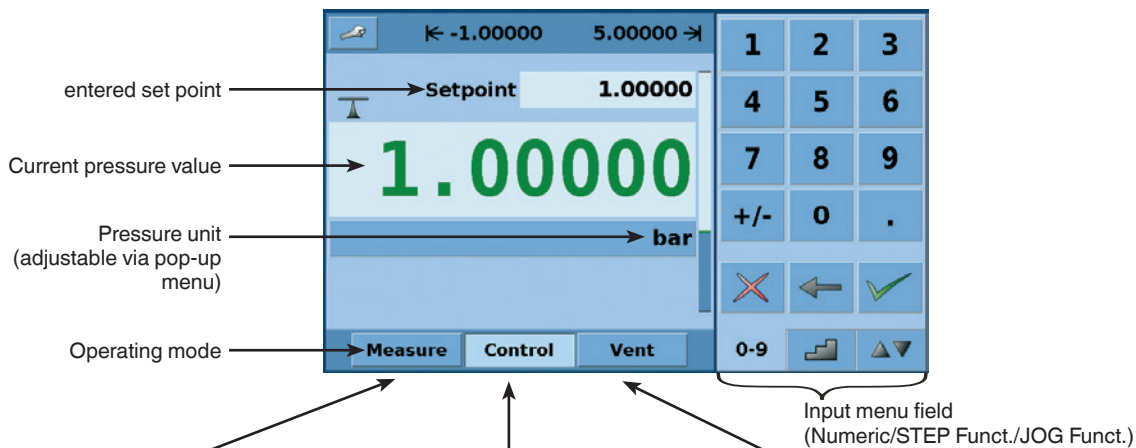

MEASURE

In measure mode, the pressure present at the test port is measured with high accuracy (if you switch directly from "CONTROL" to "MEASURE" mode, the last controlled pressure in the connected test assembly will be maintained/locked).

CONTROL

In control mode, the instrument provides a highly accurate pressure to the test port, corresponding to the desired set point.

VENT

Immediately vents the system, incl. the test assembly connected to the test port, to atmosphere.

Clear menu design (incl. expandable, helpful additional information)

The menu screen is designed particularly clearly and offers the possibility of displaying additional information via the SETUP menu (see following picture).

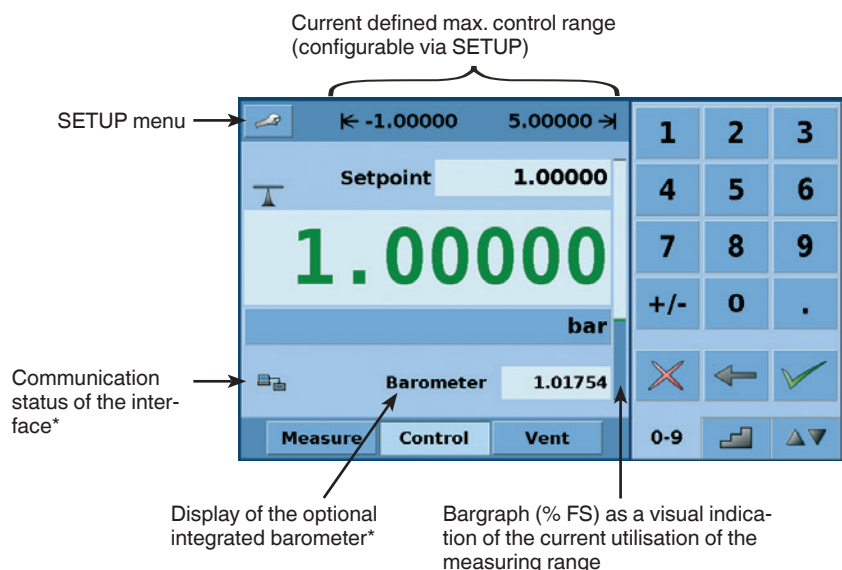

SETUP menu

via the SETUP menu, the following items can be easily configured:

- Language (17 available in total)
- Maximum control range
- STEP and JOG functions
- Communications settings
- Display of additional information

* displayed if required

Optimal setting options in 'Control' mode through three different input menu modes

A) Direct set-point input via numeric keypad

Application: numeric set-point input via touchscreen.

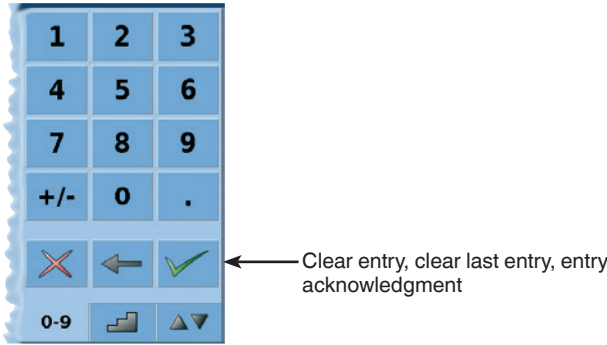

Screen with the input menu: NUMERIC

Operation

The required pressure value/set point is entered using the numeric keypad and acknowledged by pressing the green 'tick' in the buttons underneath. This provides the set point adopted by the controller, which is immediately controlled and provided at the test port.

B) Step-wise changing of the set point via defined steps using the STEP function

Application: simple calibration using defined test steps, without external software.

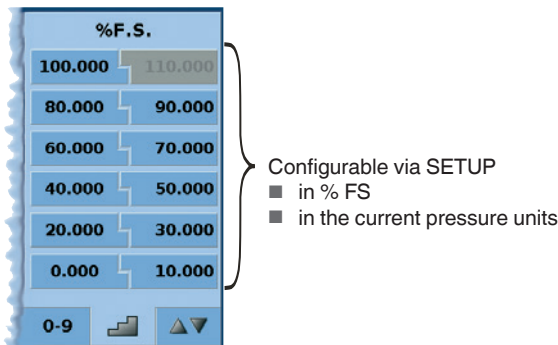

Screen with the input menu: STEP

Operation

The fields in the STEP menu contain defined set points (in % FS or actual pressure units), which are configurable via the SETUP menu. By pressing a STEP button, the corresponding pressure is immediately controlled and provided at the test port.

C) Fine adjustment of the last three significant digits of the set point using the JOG function

Application: Fine adjustment of a pressure value (up and down), e.g. to calibrate pressure gauges (bring the pointer to an exact point).

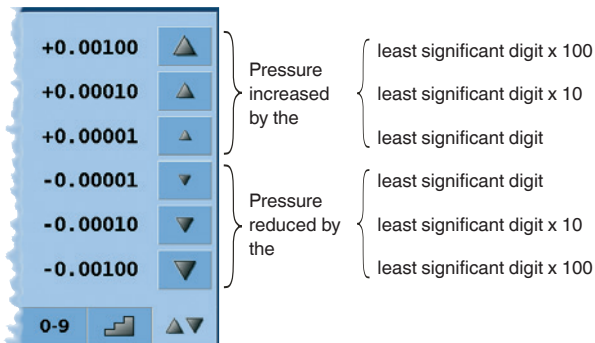

Screen with the input menu: JOG

Operation

The fields in the JOG menu contain defined values, which correspond to the last three significant digits of the current pressure value. Thus the current resolution of the pressure value directly affects the magnitude of these JOG buttons. By pressing one of the JOG buttons, the corresponding adjusted set point is immediately controlled and provided at the test port.

Dimensions in mm

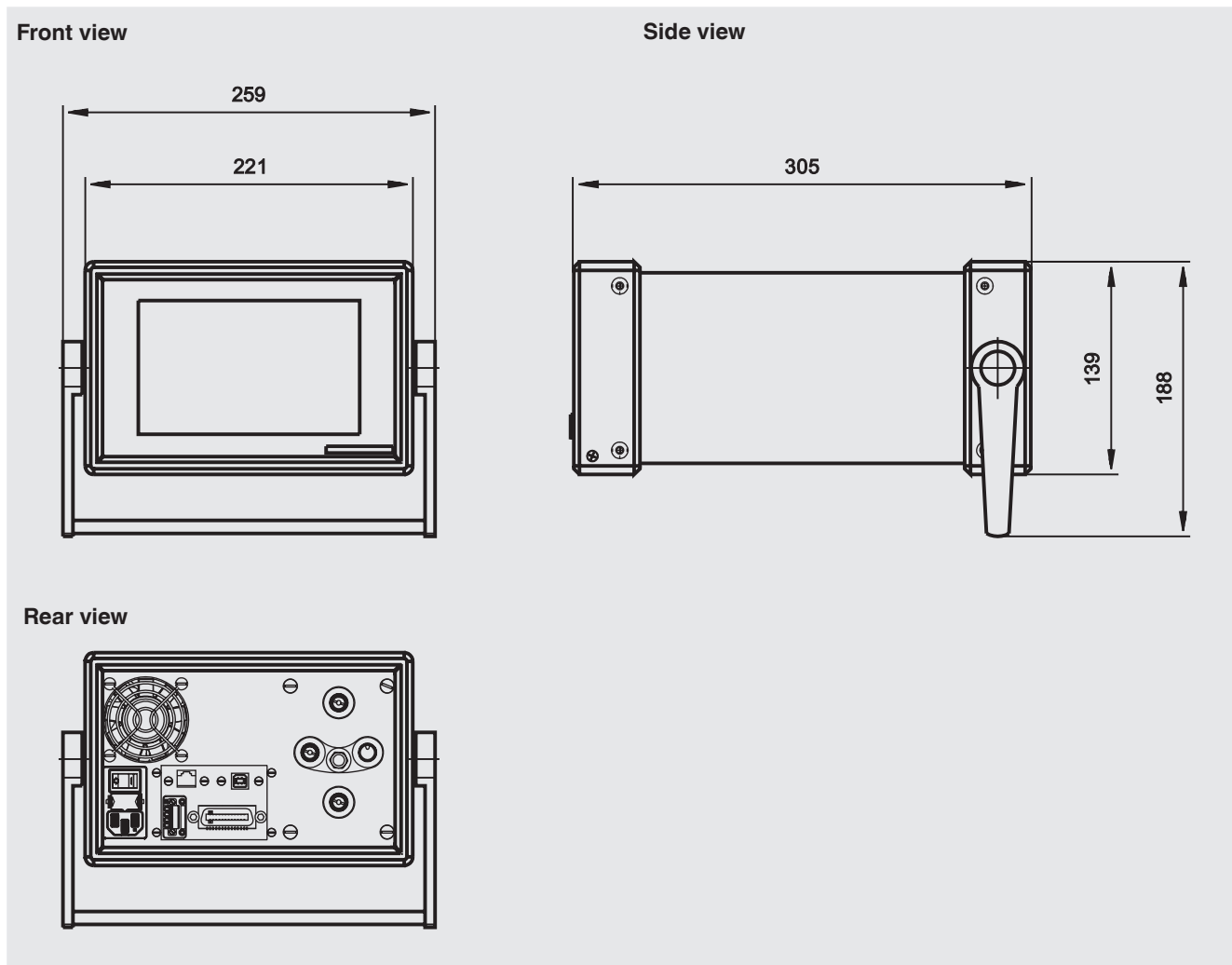

Electrical and pressure connections - rear

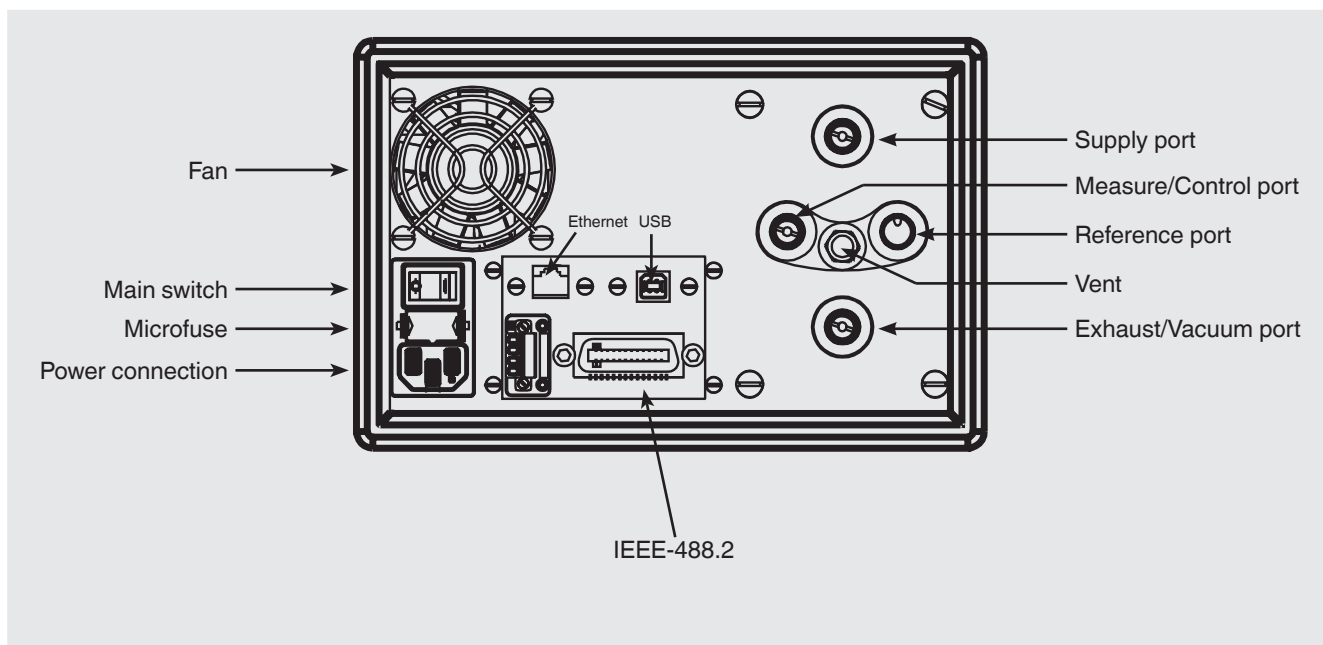

WIKA-CAL calibration software

Easy and fast creation of a high-quality calibration certificate

The WIKA-CAL calibration software is used for generating calibration certificates or logger protocols for pressure measuring instruments and is available as a demo version for a cost-free download.

A template helps the user and guides him through the creation process of a document.

In order to switch from the demo version to a full version of the respective template, a USB key with the template has to be purchased.

The pre-installed demo version automatically changes to the selected full version when the USB key is inserted and is available as long as the USB key is connected to the computer.



- Creation of calibration certificates for mechanical and electronic pressure measuring instruments
- Fully automatic calibration with pressure controllers
- Calibration of relative pressure measuring instruments with absolute pressure references and vice versa
- A calibration assistant guides you through the calibration
- Automatic generation of the calibration steps
- Generation of 3.1 certificates per DIN EN 10204
- Creation of logger protocols
- User-friendly interface
- Languages: German, English, Italian and more due with software updates

For further information see data sheet CT 95.10

Calibration certificates can be created with the Cal-Template and logger protocols can be created with the Log-Template.



Cal Demo

Generation of calibration certificates limited to 2 measuring points, with automatic initiation of pressures via a pressure controller.



Cal Light

Generation of calibration certificates with no limitations on measuring points, without automatic initiation of pressures via a pressure controller.



Cal

Generation of calibration certificates with no limitations on measuring points, with automatic initiation of pressures via a pressure controller.



Log Demo

Creation of data logger test reports, limited to 5 measured values.



Log

Creation of data logger test reports without limiting the measured values.

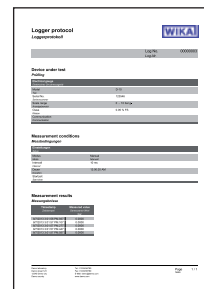
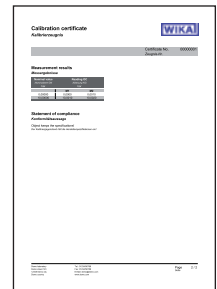
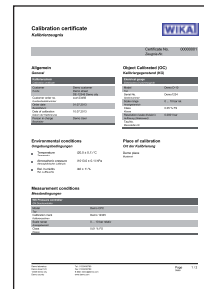

Scope of delivery

- Model CPC3000 high-speed pressure controller (desktop case with bezel and handle)
- 1.5 m / 5 ft power cord
- Operating instructions
- 3.1 calibration certificate per DIN EN 10204

Options

- DKD/DAkkS calibration certificate
- Barometric reference
- 19" rack mounting with side panels
- Customer-specific system

Accessories

- Pressure adapters
- Interface cable
- WIKA-CAL calibration software

Ordering information

Model / Housing / Pressure range basic instrument / Pressure unit / Pressure type / Minimum pressure range / Maximum pressure range / Accuracy / Type of calibration certificate / Barometric reference / Type of certificate for barometric reference / Digital interface / Pressure port adapters / Power cord / Additional order details

© 2008 WIKA Alexander Wiegand SE & Co. KG, all rights reserved.
The specifications given in this document represent the state of engineering at the time of publishing.
We reserve the right to make modifications to the specifications and materials.



WIKAL Alexander Wiegand SE & Co. KG
Alexander-Wiegand-Straße 30
63911 Klingenberg/Germany
Tel. +49 9372 132-0
Fax +49 9372 132-406
info@wika.de
www.wika.de