

Pneumatic precision pressure controller Model CPC6000



WIKA data sheet CT 27.61

Applications

- Industry (laboratory, workshop and production)
- Transmitter and pressure gauge manufacturers
- Calibration service companies and service industry
- Research and development laboratories
- National institutes and institutions

Special features

- Pressure ranges: -1 ... 100 bar (-15 ... 1,500 psi) (up to four sensors possible)
- Pressure type: positive and negative gauge pressure, absolute pressure and differential pressure via two control channels possible
- Control stability 0.003 % FS (of active sensor)
- Accuracy down to 0.01 % IS (IntelliScale)



**Pneumatic precision pressure controller,
model CPC6000**

Description

Design

Due to its modular design, the model CPC6000 pneumatic precision pressure controller offers the maximum flexibility in terms of configuration to customers' requirements. The instrument can be specified as a bench-top or as 19" rack-mount device, and is available with up to two separate channels. Each channel has its own controller unit and up to two reference pressure sensors, which can be quickly changed at any time and without the need for tools.

Application

Since up to four sensors can be integrated into the controller, the user is always offered an optimal calibration solution, even over a very wide pressure range. Moreover, the two separate controller units enable either two simultaneous calibrations or a true differential pressure calibration for static pressures, via the delta-function (channel A-B and/or channel B-A). As a result, the controller is especially suitable as a factory/working standard for the testing and calibration of all types of pressure measuring instrument.

Functionality

A colour touchscreen, combined with a very user-friendly menu, guarantees maximum operator convenience, and all

this is available in a large number of languages. In addition to specifying a certain pressure set point either by entering it via touchscreen or sending it via remote interface, the pressure can also be changed in defined, programmable step-sizes by using the STEP buttons. Moreover, the user can also easily create extensive test programs using the instrument menu.

Software

WIKA-CAL calibration and documentation software makes calibrating any type of pressure measuring instrument easy and enables the simple production of calibration certificates or the customer can create his own test programs, e.g. with the help of LabVIEW® software.

Complete test and calibration systems

On request, customised mobile or stationary test systems can be engineered. There is an IEEE-488.2, a RS-232 and an Ethernet interface for communication with other instruments, and thus the instrument can be integrated into an existing system.

Specifications Model CPC6000

Reference pressure sensors			
Pressure range	Standard		Optional
Accuracy ¹⁾	0.03 % FS	0.01 % FS	0.01 % IS-50 ²⁾
Gauge pressure	0 ... 25 to 0 ... 70 mbar (0 ... 0,36 to 0 ... 1 psi)	0 ... 0.07 to 0 ... 100 bar ³⁾ (0 ... 1 to 0 ... 1,500 psi) ³⁾	0 ... 1 to 0 ... 100 bar (0 ... 15 to 0 ... 1,500 psi)
Bi-directional	-25 ... +25 to -35 ... 35 mbar (-0.36 ... +0.36 to -0.5 ... 0.5 psi)	-0.035 ... +0.035 to -1 ... 100 bar (-0.5 ... +0.5 to -15 ... 1,500 psi)	-1 ... 10 to -1 ... 100 bar (-15 ... 150 to -15 ... 1,500 psi)
Absolute pressure	--	0 ... 0.5 to 0 ... 101 bar abs. (0 ... 7.5 to 0 ... 1,515 psi abs.)	0 ... 1 to 0 ... 101 bar abs. (0 ... 15 to 0 ... 1,515 psi abs.)
Calibration interval	180 days	365 days ⁴⁾	365 days
Optional barometric reference			
Function	The barometric reference can be used to switch pressure types ⁵⁾ , absolute <=> gauge. With gauge pressure sensors, the measuring range of the sensors must begin with -1 bar (-15 psi) in order to carry out an absolute pressure emulation.		
Measuring range	552 ... 1,172 mbar abs. (8 ... 17 psi abs.)		
Accuracy ¹⁾	0.01 % of reading		
Pressure units	38 and 2 freely programmable		

1) It is defined by the total measurement uncertainty, which is expressed with the coverage factor ($k = 2$) and includes the following factors: the intrinsic performance of the instrument, the measurement uncertainty of the reference instrument, long-term stability, influence of ambient conditions, drift and temperature effects over the compensated range during a periodic zero point adjustment.

2) 0.01 % IS-50 accuracy: Between 0 ... 50 % of the measuring span, the accuracy is 0.01 % of half the measuring span and between 50 ... 100 % of the measuring span, the accuracy is 0.01 % of reading.

3) Measuring range < 70 mbar (1 psi) Measuring span \Rightarrow 0.03 % FS.

4) Valid for pressure ranges > 1 bar (14.5 psi), else 180 days

5) For a pressure type emulation, we recommend a native absolute pressure sensor, since the zero point drift can be eliminated through a zero point adjustment.

Base instrument	
Instrument	
Instrument version	Standard: desktop case with frame and carry handle Option: 19" mounting with side panels
Channels/instrument	up to 2 separate control/measure modules
Sensors/channel	up to 2 pieces
Dimensions	see technical drawings
Weight	approx. 16.3 kg (36 lbs) (incl. all internal options)
Display	
Screen	8.4" colour LC display with resistiv touchscreen
Resolution	4 ... 6 digits
Warm-up time	approx. 15 min
Connections	
Pressure connections	up to 8 ports with 7/16"- 20 F SAE
Filter elements	The instrument has 20-micron filters on all pressure ports through the manifold.
Pressure port adapters	Standard: without Option: 6 mm Swagelok® tube fitting, 1/4" Swagelok® tube fitting, 1/4" female NPT fittings, 1/8" female NPT fittings or 1/8" female BSP fittings Standard: without Option: 6 mm Swagelok® tube fitting, 1/4" Swagelok® tube fitting, 1/4" female NPT fittings, 1/8" female NPT fittings or 1/8" female BSP fittings
Permissible pressure media	clean, dry, non-corrosive gases
Overpressure protection	Safety relief valve fixed to reference pressure sensor and adjusted to customised measuring range
Pressure generation	optional: internal, electrical pump (integrated in LP-pump module)

Base instrument	
Permissible pressure	
Supply high port	~ 110 (The LP-pump controller module does not need any external pressure supply.)
Measure/Control port	max. 110 % FS
Voltage supply	
Power supply	AC 100 ... 230 V, 50/60 Hz
Power consumption	max. 90 VA
Permissible ambient conditions	
Storage temperature	0 ... 70 °C (32 ... 158 °F)
Humidity	5 ... 95 % r. h. (relative humidity non-condensing)
Compensated temperature range	15 ... 45 °C (59 ... 113 °F)
Mounting position	horizontal or slightly tilted
Control parameter	
Control stability	< 0.003 % FS of the active sensor
Control mode	slow, medium, fast and variable
Control time	< 10 s (regarding a 10 % FS pressure increase in a 50 ml test volume)
Control range	0 ... 100 % FS
Test volume	50 ... 1,000 ccm (without throttle; leakage < 10 ⁻³)
Communication	
Interface	RS-232, Ethernet, IEEE-488.1
Command sets	Mensor, WIKA SCPI, others optional
Response time	approx. 100 ms
Internal program	up to 64 sequences with up to 99 steps each

CE conformity and certificates	
CE conformity	
EMC directive ⁶⁾	2004/108/EC, EN 61326 emission (group 1, class A) and interference immunity (industrial application)
Low voltage directive	2006/95/EC, EN 61010-1
Certificate	
Calibration ⁷⁾	Standard: 3.1 calibration certificate per EN 10204 Option: DKD/DAkKS calibration certificate

- 6) **Warning!** This is class A equipment for emissions and is intended for use in industrial environments. In other environments, e.g. residential or commercial installations, it can interfere with other equipment under certain conditions. In such circumstances the operator is expected to take the appropriate measures.
- 7) Calibration in a horizontal position/operating position.

Approvals and certificates, see website

Modular design of the CPC6000

Due to its modular design, the CPC6000 brings a high degree of flexibility and offers a wide variety of configurations.

Up to two independent control channels

One or two separate control channels can be used in one CPC6000, which allows the user to perform two different calibrations at the same time with one instrument (see figure on the right). Each channel will be equipped with its own controller module. The controller modules are based either on valve control units or on a special controller module with integrated pump (≤ 1 bar (15 psi)) so that in this case no external pressure source is necessary.



Up to four precision pressure sensors in total

Each control module can be equipped with a precision pressure sensor (or two as an option) whose calibration data are stored in the sensor.

Measuring ranges are available from 0 ... 0.025 bar to 100 bar (0 ... 0,36 psi to 1,500 psi) gauge pressure and 0 ... 0.5 bar to 101 bar (0 ... 7.5 psi to 1,515 psi) absolute pressure and also bi-directional measuring ranges.

A module can be equipped either with two gauge pressure sensors or two absolute pressure sensors (see figure on the right). The two measuring ranges of one module can either be selected automatically via auto-range function or can be selected via menu.

Furthermore, an optional barometric reference allows switching between gauge pressure and absolute pressure.

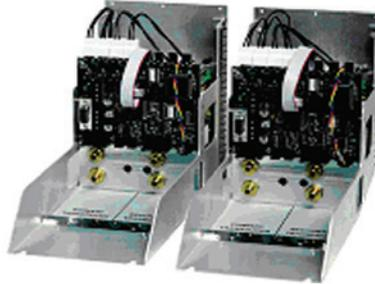

Up to two separate **controller modules** (channel A and B) per instrument



Up to two **pressure sensors** per controller module (channel)

Extremely easy to maintain

Since a pressure sensor can be dismantled and/or exchanged in just 30 seconds (plug-and-play) and a controller module in less than 5 minutes, the instrument offers a maximum in service and adaptability in shortest possible time because even sensors of different measuring ranges can be exchanged.

Optional: barometric reference sensor exchangeable like reference pressure sensors

Modular design of the hardware

Working ranges of the controller modules

Bi-directional or gauge pressure [bar (psi)] ¹⁾

-1 (-15)	0	+1 (+15)	3.4 (50)	10 (150)	100 (1,500)
LP-PUMP MODULE ± 0.025 bar (± 0.36 psi) ²⁾					
LPSVR MODULE ± 0.07 bar (± 1 psi) ²⁾					
MPSVR MODULE ± 0.7 bar (± 10 psi) ²⁾					
HPSVR ³⁾ MODULE -1 ... 5.2 bar (-15 ... +75 psi) ²⁾					

1) Mixing of absolute pressure and gauge pressure sensors in a module is not possible.

2) Smallest recommendable sensor range

3) When using a HPSVR module in a gauge pressure range above 10 bar (150 psi), please make sure that the vacuum pump is disconnected at the Supply Low port. The pump could be damaged due to the gauge pressure. For controlling absolute pressure a vacuum pump connected at the Supply Low port is required.

Working ranges of the controller modules

Absolute pressure [bar abs. (psi abs.)] ¹⁾

0	2 (30)	4.4 (60)	11 (165)	101 (1,515)
LP-PUMP MODULE 0.5 bar abs. (7.5 psi abs.) ²⁾				
LPSVR MODULE 0.5 bar abs. (7.5 psi abs.) ²⁾				
MPSVR MODULE 0.7 bar abs. (10 psi abs.) ²⁾				
HPSVR ³⁾ MODULE 5.2 bar abs. (75 psi abs.) ²⁾				

- 1) Mixing of absolute pressure and gauge pressure sensors in a module is not possible.
- 2) Smallest recommendable sensor range
- 3) When using a HPSVR module in an gauge pressure range above 10 bar (150 psi), please make sure that the vacuum pump is disconnected at the Supply Low port. The pump could be damaged due to the gauge pressure. For controlling absolute pressure a vacuum pump connected at the Supply Low port is required.

Screen representation and available functions

The instrument is available either with one or two internal precision pressure controllers (single- or dual-channel version); their representation incl. optional functions can be easily configured via touchscreen.

Except for the pressure unit which is configured directly via the pressure unit button, all settings can be easily accessed and configured via the SETUP button.

Single-channel version (up to two integrated precision sensors)

a) Standard screen representation (one control module incl. two sensors)

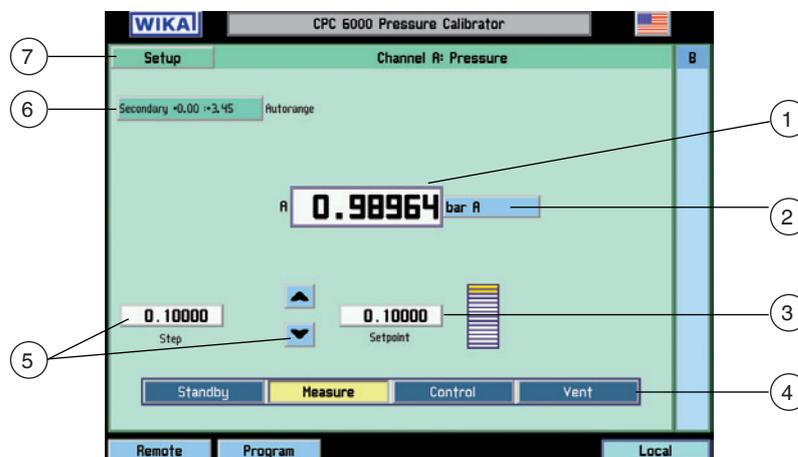

- | | |
|-------------------------------------------------------------------------------------------------------------------------------------------------------------------------------------------------|------------------------------------------------------------------------------------------------------------------------------------------------------------------------------------------------------------------------|
| <ul style="list-style-type: none"> ① Current measuring value ② Pressure unit (40 available) ③ Set point ④ Operating modes ⑤ Adjustable STEPs | <ul style="list-style-type: none"> ⑥ Select active measuring range ⑦ Setup for channel A: <ul style="list-style-type: none"> ■ Channel ■ Sensor ■ Controller |
|-------------------------------------------------------------------------------------------------------------------------------------------------------------------------------------------------|------------------------------------------------------------------------------------------------------------------------------------------------------------------------------------------------------------------------|

Further optionally available functions (configurable via SETUP menu)

- Head correction between reference and device under test
- Signal filtering
- Control speed
- Resolution

Dual-channel version (up to four integrated precision reference sensors) incl. some functions enabled

a) Standard screen representation (two control channels incl. four sensors)

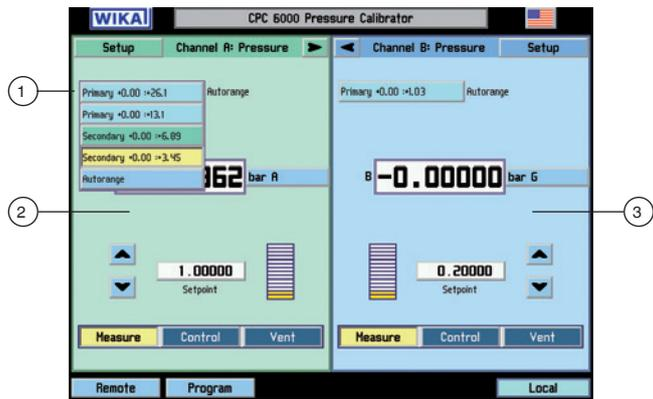

- ① Select active measuring range
- ② Window for channel A
- ③ Window for channel B

Each window can be adjusted individually, since the SETUP button refers to the respective channel selected.

b) Screen representation incl. some functions enabled (via SETUP menu) adjustable

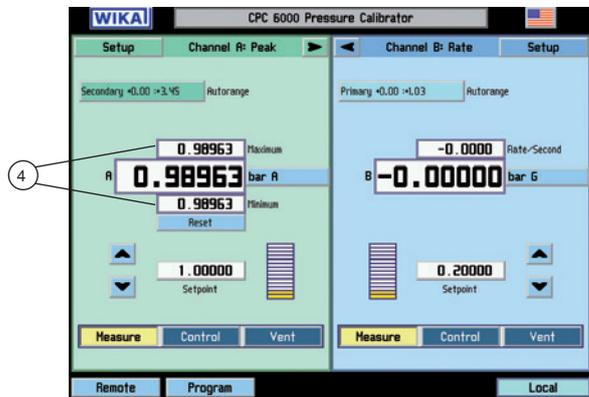

- ④ Optional fade in functions:
 - Min/Max
 - Pressure rate
 - Barometric reference

Explanations for the upper and lower toolbar

A toolbar with the following functions is located at the bottom of the display. By pressing a particular button the respective submenu will pop up.

a) Upper toolbar

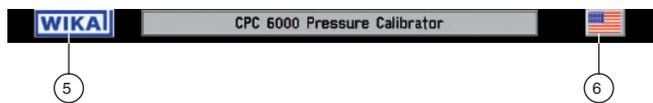

- ⑤ WIKA service address
- ⑥ Language selection

b) Lower toolbar



- ⑦ Interface SETUP
- ⑧ Programmable sequences
- ⑨ Interface status:
 - Local: manual operation via touchscreen
 - Remote: via interface

Operating modes and start-up process

I. Selection of an operating mode

The selection bar for the operating mode is at the bottom of the display (during any operating mode):



Operating mode (select by pressing the correct button):

Standby

Closes all pressure ports of the respective control channel (the current pressure will be sealed inside the system/channel)

Measurement

In measuring mode, the instrument measures the pressure connected to the test port of the respective channel very precisely (on changing from control mode: the last controlled pressure will be held/sealed in the connected test assembly).

Control

In control mode the instrument provides a very precise pressure at the test port of the respective channel in accordance with the desired value setting.

Vent

Opens all pressure ports of the respective channel to atmosphere (ventilates the system/channel)

II. Entering a set-point value in the control mode

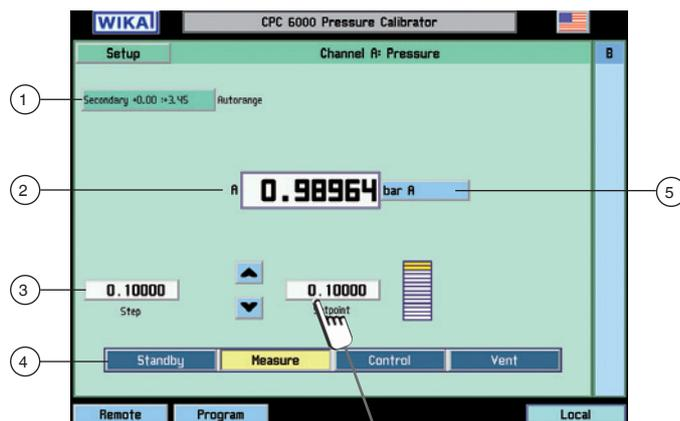

- ① Selection of sensor: 1, 2 or auto-range (1 + 2)
- ② current pressure value
- ③ Step buttons and set-point buttons
- ④ Operating mode
- ⑤ Pressure unit and type (rel./abs.)

XX.XXX = Touchscreen buttons for configuration, selection or input

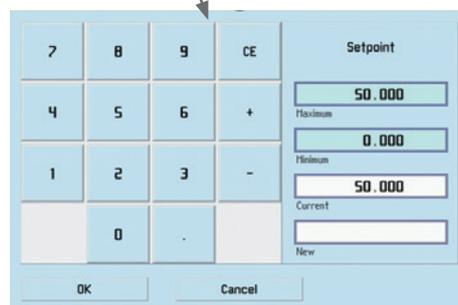

Pop-up input window for the set point

On pressing the set-point button, an input window will appear to enter a new set-point value. After confirming the input via the OK button, the controller immediately starts to control to the new set point. If the current value attains the accuracy class, the colour of the figure of the current pressure value changes from black to green.

A stepwise change of the pressure/set value is possible via the arrow-buttons, which are above and below the step and set-point button. The step size is defined through the current value of the step button.

General settings via SETUP menu for channel A

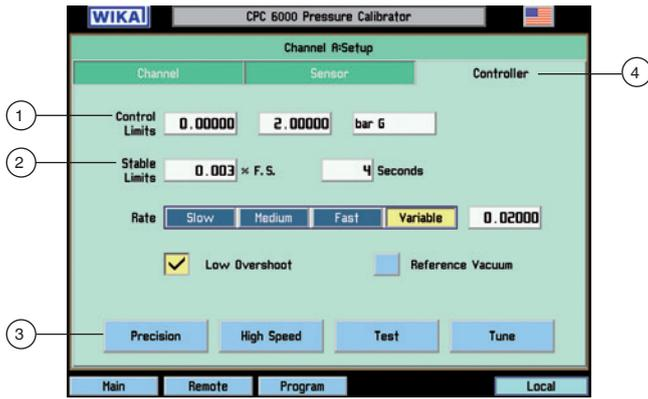

- ① Definition of control limits to protect test item
- ② Definition of stable-flag
- ③ Change of module-control performance
 - Precision control: Asymptotical control performance
 - High speed: Fast control performance
- ④ This menu is divided into three main tabs:
 - Channel: resolution/filter
 - Sensor: sensor information
 - Controller: Stable limits/control limits/control speed

Dimensions in mm (in)

Front view

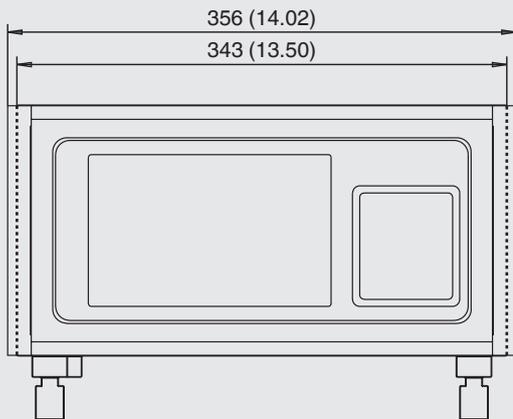

Side view (left)

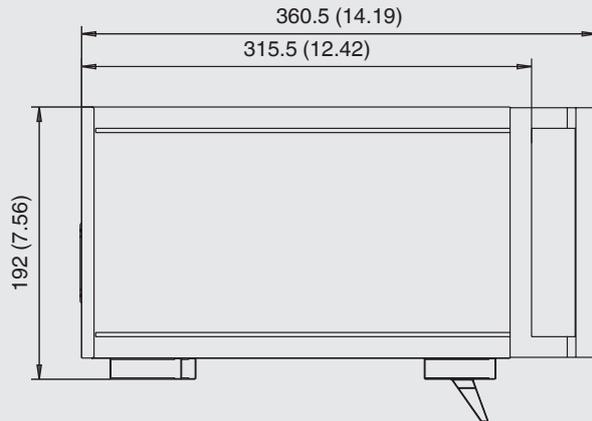

Rear view

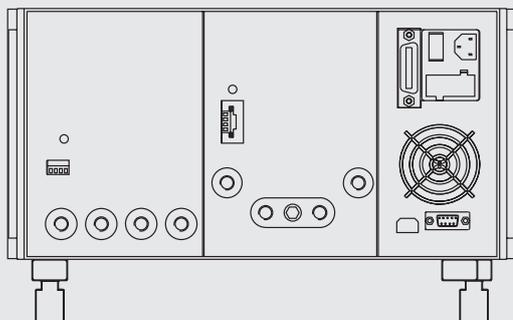

Electrical and pressure connections - rear

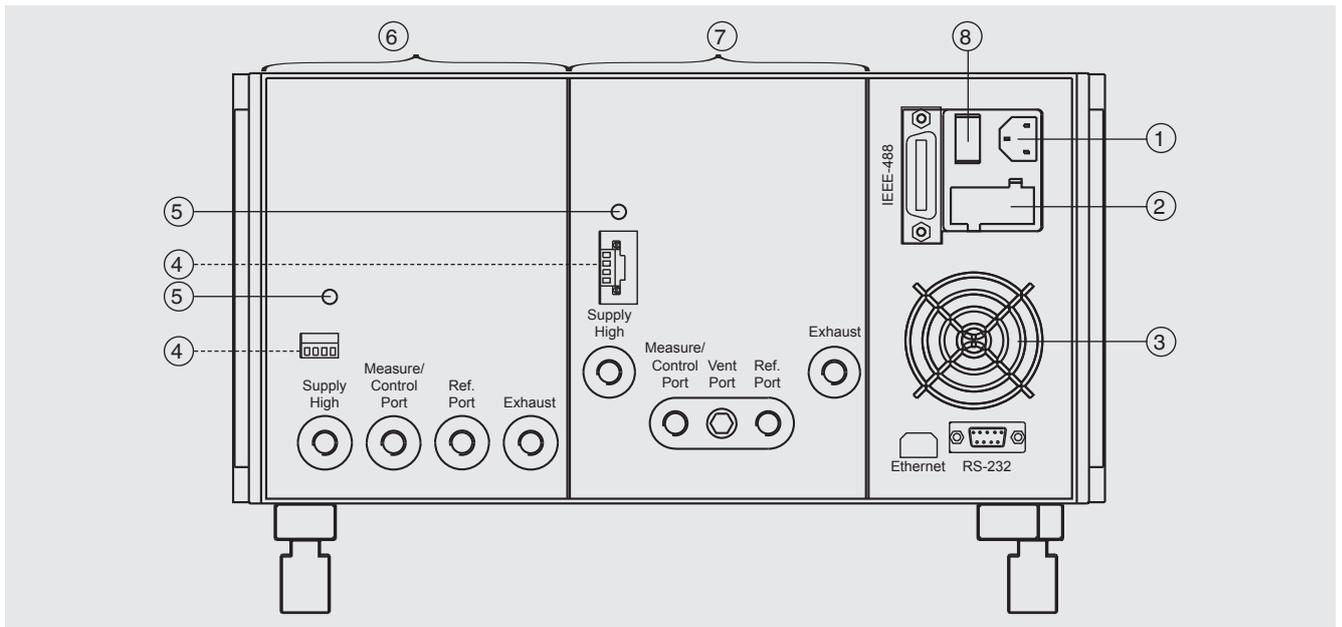

- ① Power connection
- ② Microfuse
- ③ Fan
- ④ Digital I/O
- ⑤ Optional: barometric reference port
- ⑥ (Controller pump module)
- ⑦ (Controller valve module)
- ⑧ Power switch

WIKA-CAL calibration software

Easy and fast creation of a high-quality calibration certificate

The WIKA-CAL calibration software is used for generating calibration certificates or logger protocols for pressure measuring instruments and is available as a demo version for a cost-free download.

A template helps the user and guides him through the creation process of a document.

In order to switch from the demo version to a full version of the respective template, a USB key with the template has to be purchased.

The pre-installed demo version automatically changes to the selected full version when the USB key is inserted and is available as long as the USB key is connected to the computer.

- Creation of calibration certificates for mechanical and electronic pressure measuring instruments
- Fully automatic calibration with pressure controllers
- Calibration of gauge pressure measuring instruments with absolute pressure references and vice versa
- A calibration assistant guides you through the calibration
- Automatic generation of the calibration steps
- Generation of 3.1 certificates per DIN EN 10204
- Creation of logger protocols
- User-friendly interface
- Languages: German, English, Italian and more due with software updates



For further information see data sheet CT 95.10

Calibration certificates can be created with the Cal-Template and logger protocols can be created with the Log-Template.



Cal Demo

Generation of calibration certificates limited to 2 measuring points, with automatic initiation of pressures via a pressure controller.



Cal Light

Generation of calibration certificates with no limitations on measuring points, without automatic initiation of pressures via a pressure controller.



Cal

Generation of calibration certificates with no limitations on measuring points, with automatic initiation of pressures via a pressure controller.

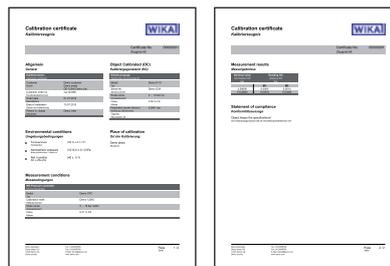

Log Demo

Creation of data logger test reports, limited to 5 measured values.



Log

Creation of data logger test reports without limiting the measured values.

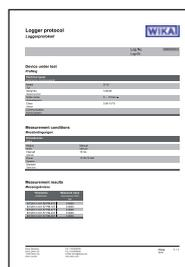

Scope of delivery

- Precision pressure controller model CPC6000
- 1.5 m (5 ft) power cord
- Operating instructions
- 3.1 calibration certificate per DIN EN 10204

Accessories

- Rugged transport box
- Pressure adapter or manual quick-clamp connections
- Interface cable
- WIKA-CAL calibration software

Options

- DKD/DAkkS calibration certificate
- Second sensor/channel
- Second channel
- Delta function for differential pressure
- Barometric reference
- 19" rack mounting with side panels
- Customer-specific system

Ordering information

Model / Housing / Channel A: Pressure controller module / Channel B: Pressure controller module / Barometric reference / Type of certificate for barometric reference / Delta function for 2-channel version / single output for 2-channel versions / Power cord / Additional order information

© 2007 WIKA Alexander Wiegand SE & Co. KG, all rights reserved.
The specifications given in this document represent the state of engineering at the time of publishing.
We reserve the right to make modifications to the specifications and materials.



WIKAL
WIKAL Alexander Wiegand SE & Co. KG
Alexander-Wiegand-Straße 30
63911 Klingenberg/Germany
Tel. +49 9372 132-0
Fax +49 9372 132-406
info@wika.de
www.wika.de