

CPC6000 Modular Precision Pressure Controller

Data Sheet CT 27.61 - CPC6000 • 02/2015

mentor

Applications

- Pressure Sensor Manufacturers
- Calibration Labs
- Aerospace
- Utilities
- Pharmaceutical / Medical / Health Care

Features

- 0.01% of Reading Accuracy (0.01% IntelliScale-50)
- 365 day calibration interval on specific ranges
- Dual channel with up to 2 Transducers per channel
- Removable / Interchangeable Transducers
- Removable / Interchangeable Barometric Reference
- Multi-language menus
- Ranges from 10 inches of water to 1500 psi

Description

Applications

The CPC6000 can be configured to match the application. This makes it particularly suited for calibration labs and production environments where a wide range of pressure sensors must be calibrated or qualified.

Functional Flexibility

Mensor's CPC6000 Modular Precision Pressure Controller (formerly the APC 600) has two independent precision pressure regulating channels which can operate simultaneously. Each channel can have up to two transducers; each transducer has an accuracy of 0.01% IntelliScale-50 with a calibration interval of 365 days on specific ranges (see page 4 for complete specification). Transducer modules and the Barometric Reference transducer can be quickly removed for calibration or service. Calibration configuration data is stored on each transducer module, which provides the capability of interchanging one transducer with another of the same, or different range. On-the-shelf spare modules can be interchanged with modules in the CPC6000 to virtually eliminate down time during calibration cycles. Manual user interface is through a color touch screen and the menus can be configured in different languages for international use.



CPC6000 Modular Precision Pressure Controller

For low pressure control (<15 psi) an innovative internal pressure generator is included which eliminates the need for an external pressure source. The CPC6000's flexible architecture, innovative user interface, and modular design make it the right choice for pressure calibration or production test environments.

Communications

To communicate with external programs for automated control, the CPC6000 is equipped with IEEE-488, RS-232 and Ethernet. Automated control of the CPC6000 can be accomplished using the remote command set. An external computer using any of a variety of software programs (LabVIEW® Drivers are available) can remotely control the functions of the CPC6000. This is useful in production environments where repetitive processes are required or in a lab environment where calibration certificates need to be produced and stored.

Calibration Certificate

Each CPC6000 is shipped with a NIST traceable calibration certificate. Mensor's calibration laboratory is accredited to ISO/IEC 17025:2005 by A2LA.

Key Features

One channel is standard but two independent channels can be installed in one CPC6000 which allows the user to perform two different calibrations simultaneously. Each channel has its own pressure regulation unit, so a high pressure and a low pressure channel can be in the same instrument.

Up to 2 interchangeable transducers can be provided on each channel, with an accuracy of 0.01% Intelliscale-50 (see page 4 for complete specification). Calibration configuration data is stored on each transducer module, which provides a capability of interchanging one transducer with another of the same or different range. On-the-shelf spare transducer modules can be interchanged with transducers in the CPC6000 to virtually eliminate down time during calibration cycles.

Removable Barometric reference can be addressed by either channel for emulation of gauge pressure from native absolute sensors or absolute from native bidirectional sensors.

A color touch screen provides an intuitive user interface that greatly reduces the operator learning curve, making the CPC6000 a quick and easy tool to learn and utilize in a production or lab environment. The user interface can be configured in 17 different languages, with additional languages possible.

Remote communications can be achieved via IEEE-488, RS-232 or Ethernet. All are standard on the CPC6000.

Transducer ranges are available from 0 - 7.5 to 0 - 1515 psia and 0 - 0.36 to 0 - 1500 psig plus bi-directional ranges. Available ranges and complete specifications are given on page 4.

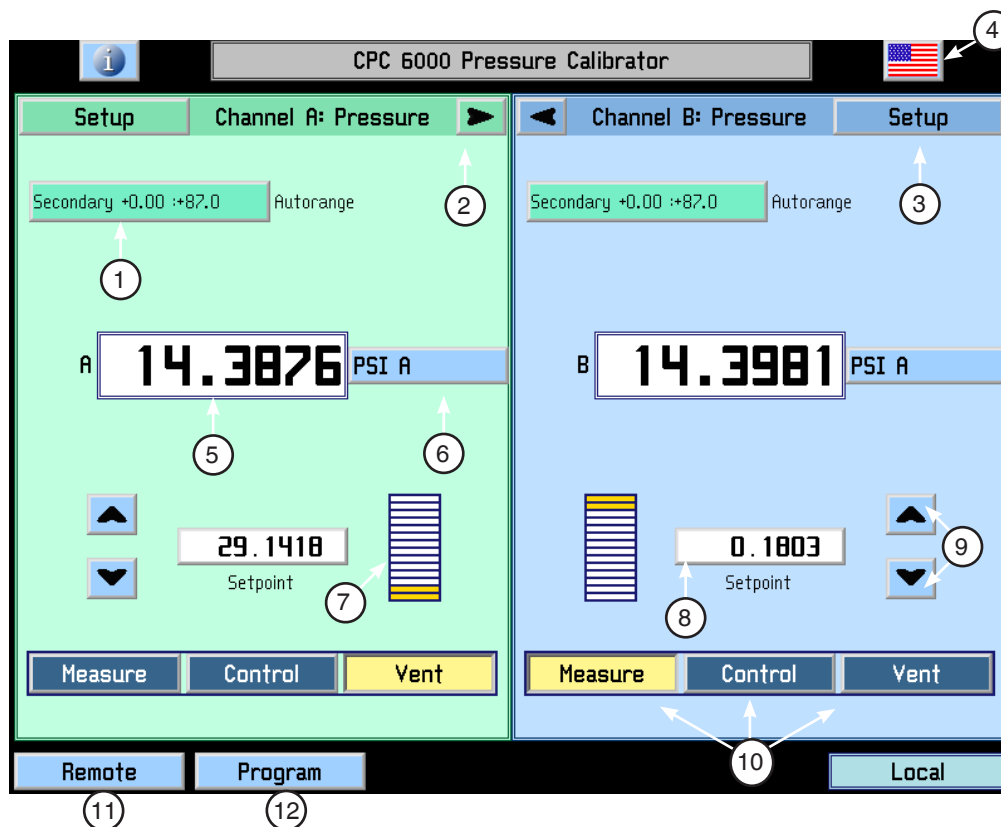

1. Range Selector: Sets the active range or auto range mode.
2. Display Key: Expands to a single channel display or returns to a dual channel display.
3. Setup: Allows setup of channel, sensors and Controller.
4. Multi-Language selector.
5. Channel indication and current pressure reading.
6. Pressure units key: displays available pressure units and selection of native or emulation mode.
7. Null Indicator: displays a relative difference between the current measured pressure and the setpoint.
8. Setpoint Value/Key: displays the setting for the controlled pressure output / opens a keypad to change the value.
9. Step Key: Increases or decreases the setpoint by a user selected value.
10. Operating Mode: Measure, Control and Vent mode.
11. Remote key displays communication parameters.
12. Program key displays sequence configuration menus.

Modular Design

The CPC6000 brings a high degree of flexibility to the automated pressure calibrator market and opens the door to a wide variety of configurations. Two independent channels means each controller can be configured with two independent pressure regulators, providing two pressure outputs. Each regulator has a standard range (see Table 1). Each channel can contain up to two internal transducers and utilize the system's removable barometric reference for display or pressure mode emulation.

Each transducer module (including the barometric reference) contains calibration, characterization, communication functions and information needed to communicate the pressure reading to the system electrical module. Modules can be removed or replaced in just 30 seconds and the pneumatic channel can be removed in less than 5 minutes. An optional calibration kit is available to calibrate the pressure modules externally. This eliminates the need to place the CPC6000 out of service during calibration of a transducer and allows the unit to operate with the remaining transducers or a replacement transducer. Transducer modules of the same or different range can be interchanged to increase utilization and productivity.

The modular nature of the CPC6000 also extends to the electrical module where software upgrades can be accomplished by removing and replacing the memory module or using a remote upgrade program.

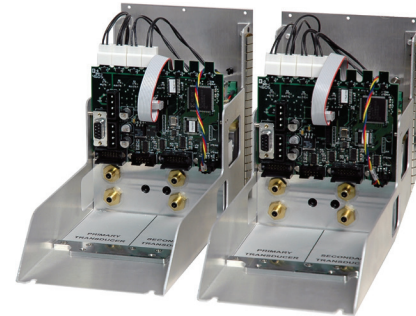

Channel module



Removable Transducers
Model CPR6000

Removable
Barometer

The Regulator

The CPC6000 has four unique pressure regulators to choose from (Table 1): **The Pump Regulator (LPPR)** utilizes a pump to both generate and regulate pressure. It can generate pressures as low as 0.5 psia. An external pressure or vacuum source can be used to achieve a quicker response to the control point. This regulator is generally used when extreme precision is needed at very low gauge pressures or when an external source is not available. **The Low Pressure Solenoid Valve Regulator (LSVR)** is recommended when the internal transducer full scale ranges fall between 1 psi and 50 psi. All SVR's require an external pressure source that is approximately 10% above the full scale range of the highest internal pressure range. **The Medium Pressure SVR (MSVR)** is recommended when the internal full scale ranges fall between 10 psi and 150 psi. **The High Pressure SVR (HSVR)** is recommended when the internal transducer full scale ranges fall between 75 and 1500 psi.

All of the CPC6000 regulators have specific programmable coefficients that control the speed and stability characteristics of the controlled pressure. Each regulator can be tuned to meet

a specific customer requirement. Specific control requirements, such as control speed, overshoot and external volume, are just a few of the variables that the CPC6000 regulator is able to accommodate.

The Pump Regulator can be adjusted to accommodate different external volumes or set to "auto tune" which automatically senses the external volume and adjusts accordingly.

Regulators for Bi-directional, Gauge and Absolute modes are shown in Table 1 below.

	Bi-Directional		Gauge		Absolute	
	Min. Span	Max	Min	Max	Min	Max
LPPR	.36	-15 to +15	0-.36	0-15	0-7.5	0-30
LSVR	1	-15 to 50	0-1	0-50	0-7.5	0-65
MSVR	10	-15 to 150	0-10	0-150	0-15	0-165
HSVR	75	-15 to 1500	0-75	0-1500	0-75	0-1515

Table 1

The Transducer Model CPR6000

The transducers and the optional barometer are configured in a proprietary process characterizing each range over a temperature of 15 to 45 °C. This process has been developed and optimized to give greatest accuracy, stability and reliability. Each range is calibrated with NIST traceable primary standards and provided with a calibration certificate from our A2LA accredited laboratory.

Transducers can be of three types: “Intelliscale Transducers” (IS), “Turndown Transducers”(TD) or Barometric reference (baro).

Intelliscale Transducers (IS) have an uncertainty of 0.01% Intelliscale-50 (0.01%IS-50). This specification is a percent of reading specification with a 365 day calibration stability and is explained in the Transducer Specification section below. The 0.01%IS-50 specification is available in all new CPC6000's and applies to full scale ranges above 15 psi absolute or gauge.

Turndown Transducers (TD) can have two ranges configured on each transducer. These ranges are referred to as turndowns and

each one has an uncertainty of 0.01%FS (0.03%FS for ranges < 1 psig) with a calibration stability of 180 or 365 days depending on the range. The second (lower span) turndown cannot have a span that is less than 50% of the primary turndown span.

On-the-shelf spare modules can be interchanged with modules in the CPC6000 to virtually eliminate down time during calibration cycles. Transducers can be used in 'Range Hold' mode or 'Auto Range' mode to optimize accuracy over a wide range of pressures. A removable barometric reference is optional, permitting the CPC6000 to emulate either gauge or absolute pressures.

All CPC6000's are custom manufactured for specific customer requirements. Our technical sales staff is available to guide you in the selection of appropriate transducers that will cover your application at the lowest possible cost. This process involves optimizing the mix of ranges and regulators in the CPC6000 to allow calibration of all of your sensors at appropriate test uncertainty ratios.

Transducer Specification

Uncertainty		Total Uncertainty Definitions:
<p>TD Transducer Example</p>	<p>IS Transducer Example</p>	<p>Max = the maximum value of a range, also known as the full scale value. Example, for a range of -15 ... 145, Max = 145</p> <p>Min = the minimum value of a range. Example, for a range of -15 ... 145, Min = -15</p> <p>Full Span (FS) = Max - Min. Example, for 0 ... 145 the Full Span is 145, for -15 ... 145 the Full Span is 160.</p> <p>Reading = The value of the sensor output</p> <p>TD = Turndown Transducers (TD) can have two ranges. The first is Min ... Max range. The second cannot be less than 50% of the Max - Min and must be contained within the first range.</p> <p>IS = Intelliscale is a combination of %Max range and %Reading</p> <ol style="list-style-type: none"> (1) Total Uncertainty (k=2) includes hysteresis, linearity, repeatability, reference standard, drift and temperature effects over the calibrated range for the calibration interval specified, with periodic re-zeroing. (2) 0.01% Intelliscale-50 (0.01% IS-50): Uncertainty from Min to 50% of Max = (0.010% x 50% x Max) or 0.010% of Reading from 50% to 100% of Max. (3) 0.01% Full Span (0.01% FS) = Uncertainty of 0.01% of the Full Span. (4) 0.03% Full Span (0.01% FS) = Uncertainty of 0.03% of the Full Span.
Gauge		
Type	Transducer Range (psig)	Total Uncertainty ⁽¹⁾ (calibration Interval)
TD	0 ... 0.36 to 0 ... < 1	0.03%FS ⁽⁴⁾ (180 days)
TD	0 ... 1 to 0 ... < 14.5	0.01%FS ⁽³⁾ (180 days)
IS	0 ... 14.5 to 0 ... 1500	0.01%IS-50 ⁽²⁾ (365 days)
TD	0 ... 14.5 to 0 ... 1500	0.01%FS ⁽³⁾ (365 days)
Absolute		
Type	Transducer Range (psia)	Total Uncertainty ⁽¹⁾ (calibration Interval)
TD	0 ... 7.5 to 0 ... < 14.5	0.01%FS ⁽³⁾ (180 days)
IS	0 ... 14.5 to 0 ... 1515	0.01%IS-50 ⁽²⁾ (365 days)
TD	0 ... 14.5 to 0 ... 1515	0.01%FS ⁽³⁾ (365 days)
Baro	8..17 psia (can be utilized by both channels)	0.01% of reading (365 days)
Bi-Directional		
Type	Transducer Range (psi)	Total Uncertainty ⁽¹⁾ (calibration Interval)
TD	-0.18 ... +0.18 to -0.5 ... 0.5	0.03%FS ⁽³⁾ (180 days)
TD	-0.5 ... 0.5 to -5 ... +14.5	0.01%FS ⁽³⁾ (180 days)
TD	-5 ... +14.5 to -15 ... +1500	0.01%FS ⁽³⁾ (365 days)
IS	-15 ... 145 to -15 ... 1500	0.01%IS-50 ⁽²⁾ (365 days)

Intuitive User Interface

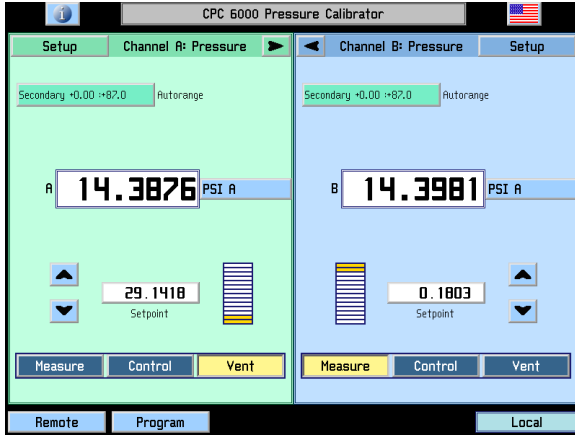

MAIN OPERATING SCREEN

The main operating screen appears after turning on the CPC6000. It is the starting point to move to any other screen. Measurement and control is accomplished here.

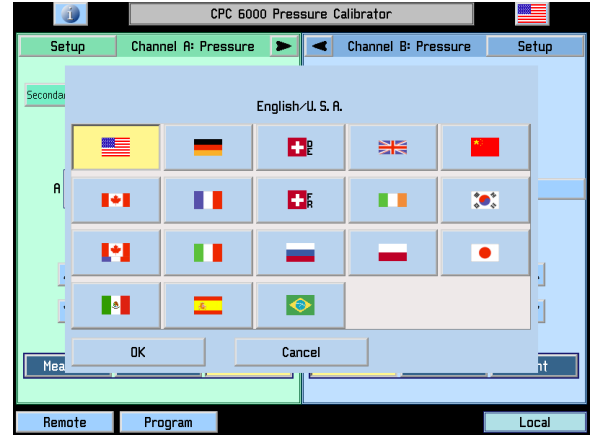

MULTIPLE LANGUAGE SCREEN

Languages are indicated by national flags.

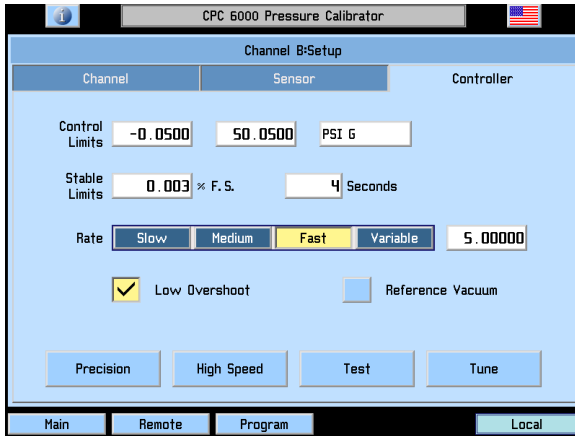

SETUP SCREENS

Setup screens are used to set up conditions for functions related to the channel, the transducer or the controller.

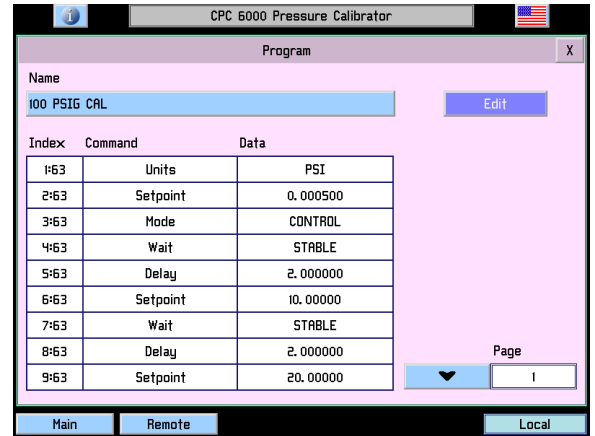

PROGRAM SCREEN

The program screen allows detailed sequences to be saved. Up to 64 sequences can be programmed with up to 99 steps. Sequences can have alpha-numeric names.

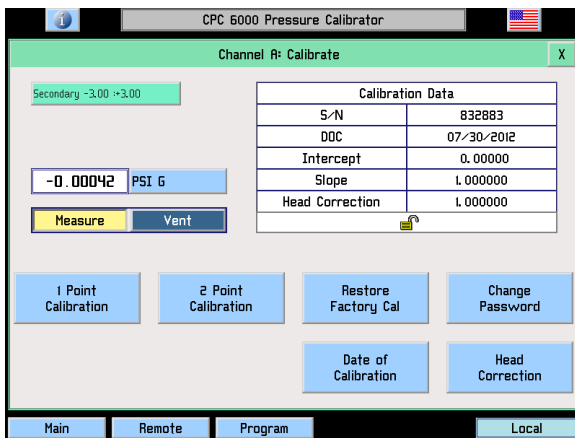

CALIBRATION SCREEN

The calibration screen is a password protected screen used to calibrate the transducer ranges within the CPC6000.

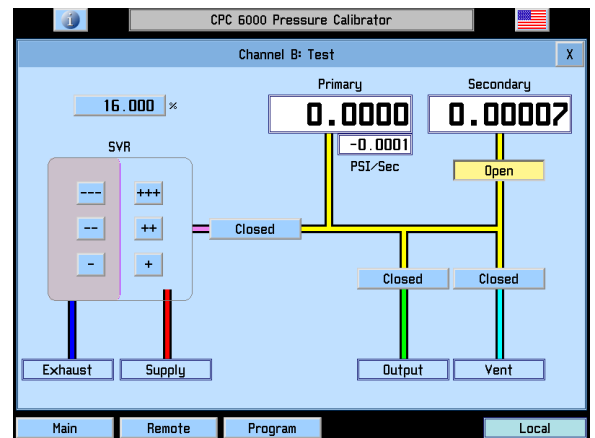

DIAGNOSTICS

Diagnostics screen allows manual touch screen control of the regulator and pneumatic control solenoids.

Options

Two virtual delta functions are available: A-B and B-A. The CPC6000 with the Virtual Delta Software can display Channel A and B, Channel A and Delta or Delta and Channel B. In the screen below, delta is displayed on the right and is either A-B or B-A as selected. A is displayed on the left and is the leading channel. Channel B's reading is displayed where the range information normally appears on the Delta channel. Channel B is the following channel. Whenever the A channel is changed, the B channel setpoint follows to maintain the differential setpoint displayed on the Delta channel. Whenever the Delta channel setpoint is changed, the B setpoint is changed as well. The delta functions are strictly a mathematical difference between the two physical channel readings. There is no pressure connection between the channels. This option is useful for calibration of differential transducers at line pressure.

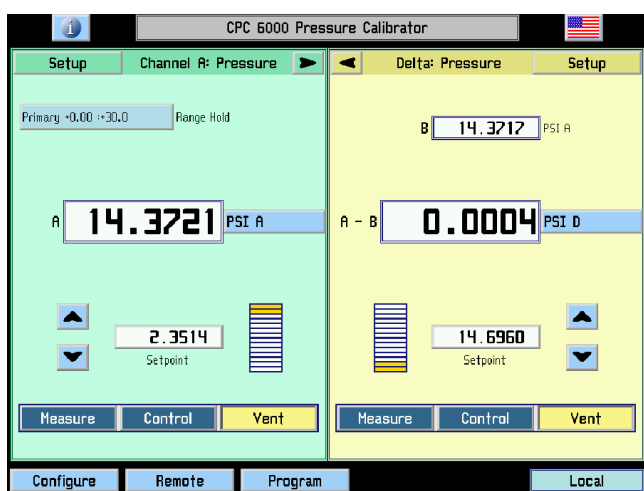

The removable Barometric Reference Transducer option is an absolute pressure device used to accurately measure local atmospheric pressure. It can also be used to emulate gauge mode pressure from absolute sensors or absolute mode from gauge sensors. This is done by simply subtracting or adding the barometric reading from the reading of the absolute or gauge sensor ranges in a channel. The barometric reference has an uncertainty of 0.01% of reading with a recommended calibration interval of 365 days.



Additional transducers (Model CPR6000) can be purchased as an option. Transducers will work within any channel as a replacement for another transducer in addition to the transducer already in place. Although transducers will work in any channel, the range of the regulator must be considered to insure optimum performance. Choosing a transducer that matches the channel and regulator is explained on page 3 and 4 of this brochure.



A rack mount kit allows the customer to install an CPC6000 into a standard 19" instrument rack. It includes pre-installed brackets on the sides of the instrument as well as spacer panels (not pictured) and hardware to rack mount the CPC6000.



A wheeled transport case suitable for moving the CPC6000 between sites, or as an airfreight shipping container. The case is constructed of a high impact plastic with a black exterior. It includes two keys, locks, a vinyl satchel style handle and a retractable pullout handle. The interior is filled with high density polyurethane foam with a die-cut cavity to cradle the instrument with fitting adapters in place, and an additional cavity to store related accessories. Rugged and weather resistant, the case makes an attractive, practical shipping and moving container.



The calibration sled allows customers to calibrate transducers outside the CPC6000. This allows the customer to continue using the other ranges inside the CPC6000, while calibrating one of the transducers in order to reduce down time. The calibration sled Kit includes the serial interface software, the Calibration Sled, a serial cable to connect the sled to the host computer, and a power supply (not pictured) to power up the Calibration Sled.



Mensor provides custom systems which can consist of Mensor products, computers, software, pressure and vacuum sources, valves, regulators, tubing, specified fittings, Mensor custom components, DMMs, and any other components specified. Systems can be racks, test benches, portable carts, vibration resistant cases or cabinets. The Mensor team works closely with customers to develop systems to meet their specific requirements.



Order Entry: Configuring the CPC6000

Initial Considerations

Because our customers have a variety of needs, we have made the CPC6000 configurable to suit a wide range of requirements. Our Technical Sales staff is available to guide you in the selection of appropriate regulator and transducers that will cover your application. This process involves optimizing the mix of ranges to allow calibration of all of your pressure instruments at appropriate test uncertainty ratios. To do this the range of the pressure instrument and accuracy must be considered and compared to the range and accuracy of the transducers in the CPC6000.

The CPC6000 configuration depends on the mode (absolute, gauge, bi-directional), range and the uncertainty of the pressure instruments being tested. The mode of the calibrator and the mode of the device being tested must be the same. Each channel of the CPC6000 must be configured with either absolute or gauge transducers. Absolute and gauge transducers cannot be used simultaneously on the same channel, however, absolute and gauge transducers can be interchanged with one another within a channel. So, a channel can be populated with absolute transducers or gauge transducers but not both at the same time.

A Barometric Reference can be added to emulate gauge from absolute transducers or absolute from gauge transducers. When in emulation mode the uncertainty is the RSS of the uncertainty of the transducer being used and 0.01%R of the barometer. When emulating absolute pressures in the sub-atmospheric range the gauge transducer ranges used must be spanned from negative one atmosphere up to the desired full scale pressure.

The CPC6000 is ideally suited for applications where there is a need to calibrate multiple ranges that are a mix of both gauge and absolute ranges. Any two of the four regulators plus custom transducer ranges from 0 - 0.36 psig up to 0 - 1500 psig or 0 - 7.5 psia up to 0 - 1515 psia will combine to produce a unique CPC6000 ideally suited for almost any application.

Configuration

To start the process, **first decide if a single or dual channel CPC6000 is required.** A single channel CPC6000 has one regulator and either one or two transducers. A dual channel CPC6000 has two regulators and can have up to four transducers. **Second, select the regulator that will cover the ranges that are needed.** Table 2 shows the available pressure regulators. **Third, choose the transducer ranges needed.** Transducer ranges can be any range within Min / Max range of the regulator. **Forth, add any options and / or accessories from page 6.**

	Bi-Directional		Gauge		Absolute	
	Min. Span	Max	Min	Max	Min	Max
LPPR	.36	-15 to +15	0-.36	0-15	0-5	0-30
LSVR	1	-15 to 50	0-1	0-50	0-5	0-65
MSVR	10	-15 to 150	0-10	0-150	0-15	0-165
HSVR	75	-15 to 1500	0-75	0-1500	0-75	0-1515

Table 2

Table 3 is a typical CPC6000 configuration. The absolute transducers can emulate gauge using the Barometric Reference.

	Regulators	
	HSVR	HSVR
Transducer 1	1515 psia	379 psia
Transducer 2	758 psia	190 psia

Table 3

This configuration takes advantage of the percent of reading portion of each transducer and gives 0.01% of reading from 1515 psia down to 95 psia (Figure 3).

Figure 3

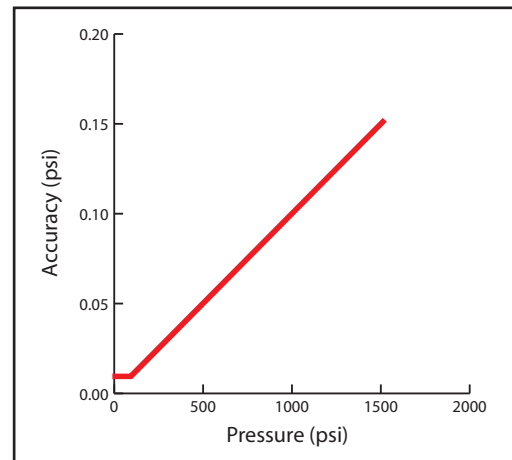

Figure 4 shows a complete description of this CPC6000. This is the preferred format showing all of the information for each channel and options that might be added.

Mensor Model CPC6000
Channel A: HSVR
Transducer 1:
Range: 0-1515 psia
Transducer 2:
Range: 0-758 psia
Channel B: HSVR
Transducer 1:
Range: 0-379 psia
Transducer 2:
Range: 0-190 psia
Accuracy 0.01%FS Intelliscale-50
Communication: IEEE-488, RS-232 and Ethernet
Barometric reference
Rack Mount

Figure 4

Specifications**Measure Specifications**

Total uncertainty	See page 4 "Transducer Specification".
Pressure ranges	Specific custom ranges between 0.36 to 1500 psig or 5 to 1515 psia. See page 4. Optional barometric reference: 8 to 17 psia
Pressure units	psi, inHg@0°C and 60°F, inH ₂ O@4°C, 20°C and 60°F, ftH ₂ O@4°C, 20°C and 60°F, mTorr, inSW@0°C, ft SW@0°C, mSW@0°C, ATM, bar, mbar, mmH ₂ O@4°C and 20°C, cmH ₂ O@4°C and 20°C, MH ₂ O@4°C, mmH ₂ O@0°C, cmHg@0°C, Torr, hPa, kPa, Pa, Mpa, D/cm ² , G/cm ² , Kg/cm ² , OSI, PSF, TSF, TSI, µHg@0°C, %FS and 2 user-defined units.

Control Specification for Low Pressure Control Module (Pump Regulator)

Source pressure requirements	Fast mode: 10% over range of highest pressure transducer. Slow mode: None.
Exhaust pressure requirements	Fast mode: A vacuum source is required for sub-atmospheric pressure control. Slow mode: one.
Stability of controlled pressure	Fast and slow mode: 0.003% of active range - typically better than 0.001% of span 10 seconds after displaying stable flag.
Available sensor range	Absolute: 0 to 7.5 psia to 0 to 30 psia. Gauge: 0 to 0.36 psig to 0 to 15 psig. Bi-directional: -0.18 to +0.18 to -atm to 15 psig.
Minimum controlled pressure	0.05% of full scale or 0.05 psi over exhaust pressure, whichever is greater. The minimum control point on absolute ranges is 0.5 psia.
Control time	Fast mode: <10 seconds to stable flag for 10% FS step pressure change into a 50 cc volume. Slow mode: <15 seconds to stable flag for 10% FS step pressure change into a 50 cc volume. In both cases larger volumes can lengthen this time. Controlling to low absolute pressures will increase this time.

Control Specification for Low, Mid and High Pressure Range Regulator Modules (LSVR, MSVR and HSVR)

Source pressure requirements	10% over range of highest pressure transducer or 20 psi over highest pressure transducer for a pressure channel, whichever is less.
Exhaust pressure requirements	A vacuum source is required for sub-atmospheric pressure control.
Stability of controlled pressure	0.003% of span on active range. Typically better than 0.001% of span 10 seconds after displaying stable indication.
Maximum control pressure	See Table 2 on page 7.
Minimum control pressure	0.05% FS or 0.025 psi over exhaust pressure, whichever is greater.
Control time	Approximately 10 seconds to stable flag for 10% pressure change in highspeed mode. 25 seconds to stable flag for 10% pressure change in precision mode. These times are achieved using a 50cc volume. Larger volumes can lengthen this time. Controlling to pressures less than 5 psia can also lengthen this time.
Pressure control rate settings	Slow, Medium, Fast, and Max (default).
Supply consumption	<2.5 scfh in steady-state control.

General Specifications

Remote User Interfaces	RS-232 (which requires a null modem cable), Ethernet, and IEEE-488 are standard.
Warm-up	Less than 15 minutes.
Display	8.4" color LCD display with 8 wire resistive touch screen.
Case size	14.02" wide x 7.55" high x 12.42" deep (35.61 cm x 19.2 cm x 31.55 cm).
Weight	36 lbs. (16.3 kg) with all internal options.
Pressure media	Clean, dry, non-corrosive, non-combustible, non-oxidizing gases. Not suitable for Oxygen use.
Pneumatic interfaces	7/16-20 Female SAE, 1/8 FNPT adaptors included.
Power input requirement	100-240 VAC, 47-63 Hz, 92 VA max.
Temperature	Operating Temp: 0C to 49C; Compensated Temp: 15C to 45C; Storage Temp: 0C to 70C;

The calibration program at Mensor is accredited by A2LA as complying with both the ISO/IEC 17025:2005 and the ANSI/NCSS Z540-1-1994 standards. All Mensor primary standards are traceable to NIST. Mensor is registered to ISO 9001:2008.



Mensor
201 Barnes Drive
San Marcos, Texas 78666
Tel: 512.396.4200
Fax: 512.396.1820
Email: sales@mensor.com
www.mensor.com