

# Tubeskin thermocouple assembly Model TC59-W

WIKA data sheet TE 65.58



further approvals  
see page 7

**WELD-PAD**

## Applications

- Chemical industry
- Power generation
- Refineries
- Heating furnaces
- Heat exchangers

## Special features

- Application ranges from 0 ... 1,260 °C (32 ... 2,300 °F)
- Flexible sheathed cable, mineral-insulated internal leads
- High mechanical strength, shock-resistant
- Explosion-protected versions



**Tubeskin thermocouple assembly, model TC59-W**

## Description

The WELD-PAD enables the measurement of temperatures on plain or contoured surfaces.

The WELD-PAD sensor hot end is a contoured weld-pad attached to a mineral-insulated cable (sheathed cable). It consists of a metal outer sheath, which contains the insulated internal leads, compressed within a high-density ceramic composition. The internal leads are made from thermo material. The material of the outer sheath can be selected to match the application. At one end of the sheathed cable, the internal leads are welded together to form an insulated (ungrounded) or non-insulated (grounded) measuring point.

At one end of the sheathed cable, the ends of the leads are connected and the sheathed cable is hermetically sealed using a sealing compound. The lead ends form the platform for the electrical connection. Cables, plug-in connectors or connector sockets can be connected to them.

### Sensor design

The WELD-PAD is designed as a contoured weld pad designed to suit each tube and sensor size.

The WELD-PAD design is used in low variability applications where accuracy is not critical. It provides measurement readings for trending, excursions and tracking.

When critical accuracy is required refer to data sheets TE 65.56, TE 65.57 and TE 65.59

## Sensor

### Sensor types

Type	Recommended max. operating temperature	
	IEC 60584-1	ASTM E230
K	1,200 °C (2,192 °F)	1,260 °C (2,300 °F)
J	750 °C (1,382 °F)	760 °C (1,400 °F)
N	1,200 °C (2,192 °F)	1,260 °C (2,300 °F)
E	900 °C (1,652 °F)	870 °C (1,598 °F)

Thermocouple	Class	
Type	IEC 60584-1	ASTM E230
K	1 and 2	Standard, special
J	1 and 2	Standard, special
N	1 and 2	Standard, special
E	1 and 2	Standard, special

### Tolerance value

For the tolerance value of thermocouples, a cold junction temperature of 0 °C has been taken as the basis.

When using a compensating cable or thermocouple cable, an additional measuring error must be considered.

### Sensor junction

The WELD-PAD is supplied as an insulated (ungrounded) or non-insulated (grounded) measuring point.

For detailed specifications for thermocouples, see Technical information IN 00.23 at [www.wika.com](http://www.wika.com).

## Mechanical design

### Sensor

Through its pad design the WELD-PAD provides a strong welded connection on three sides.

### Sheathed cable

The sheathed cable is flexible. The minimum bending radius is five times the sheath diameter.

### Sheath diameter

- 6.0 mm
- 6.4 mm (1/4")
- 7.9 mm (5/16")
- 9.5 mm (3/8")

Other sheath diameters on request

### WELD-PAD and sheath materials

- Ni-alloy 2.4816 (Inconel 600)
  - up to 1,200 °C / 2,192 °F (air)
  - standard material for applications which require specific corrosion resistance properties under exposure to high temperatures, resistant to induced stress corrosion cracking and pitting in media containing chloride
  - highly resistant to halogens, chlorine, hydrogen chloride
  - problematic applications in sulphurous fuels
- Steels
  - up to 850 °C / 1,562 °F (air)
  - good corrosion resistance with aggressive media as well as steam and flue gases in chemical media

WELD-PAD material	Resistance in	
	sulphurous ambient	maximum temperature
2.4665 (Hastelloy X®)	Medium	1,150 °C (2,102 °F)
2.4816 (Inconel 600®)	Low	1,150 °C (2,102 °F)
Stainless steel 1.4841 (310)	Medium	1,150 °C (2,102 °F)
Stainless steel 1.4749 (446) <sup>1)</sup>	High	1,150 °C (2,102 °F)
Haynes HR 160®	Very high	1,200 °C (2,192 °F)
Pyrosil D®	High	1,250 °C (2,282 °F)
Stainless steel 1.4401 (316)	Medium	850 °C (1,562 °F)

Other materials on request

1) Depending on design

## Design and electrical connection

WELD-PAD thermocouples are classified into the following variants, depending on the nature of their electrical connections:

### Fixed connection (compression fitting) to the furnace

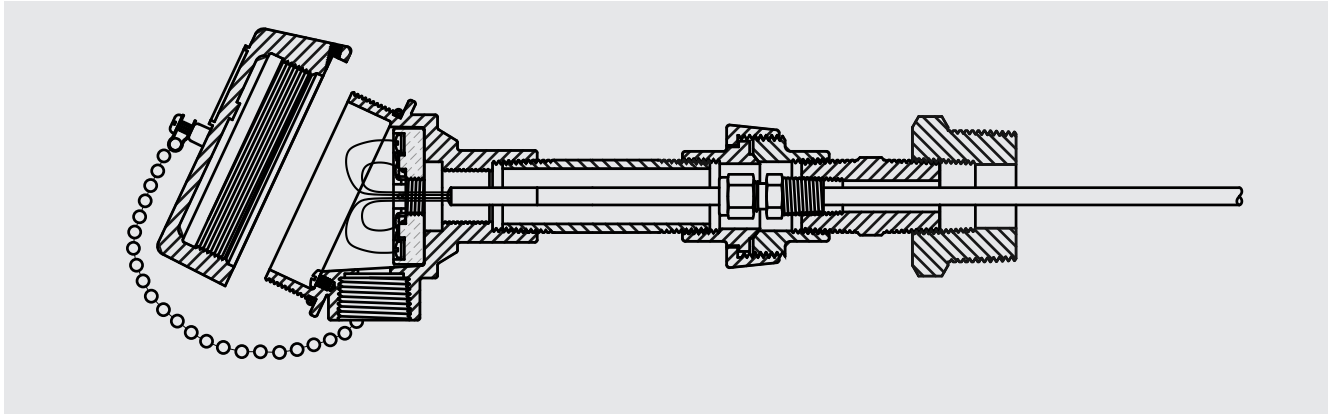

- Cable length 150 mm, other lengths on request
- Compensating cable type depending on the sensor type, PTFE-insulated
- The sealing from the process is performed by the compression fitting. It can be supplied in most common thread sizes.
- A connection head can be mounted directly to the neck or remotely.

### Sliding connection (piston/spring) to the furnace

#### Spring-loaded style

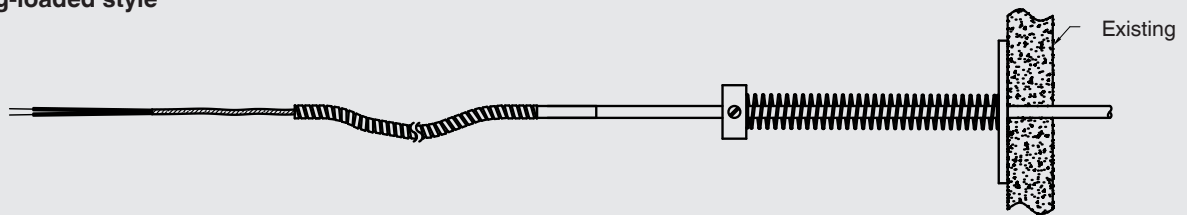

#### Piston style

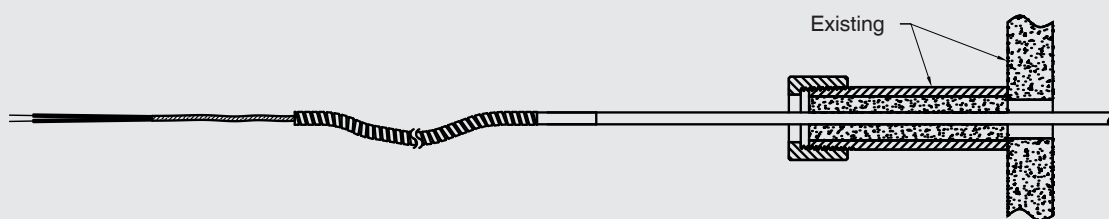

- Cable length to user specifications
- Number of leads depends on the number of sensors, lead ends bare
- Insulation (material / ambient temperature max.):
  - PVC 105 °C (221 °F)
  - PTFE 250 °C (482 °F)
  - Fibreglass 400 °C (752 °F)
- A connection head can be mounted remotely.

## Connection head

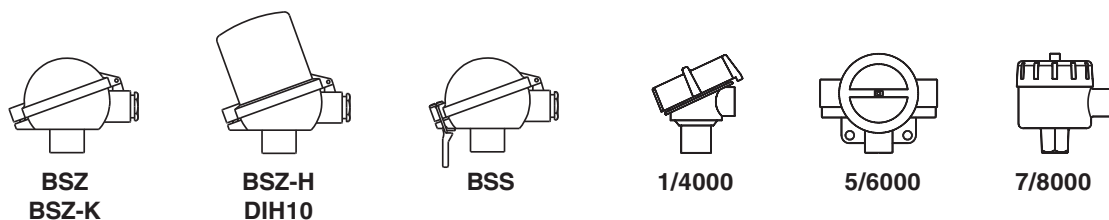

Model	Material	Cable entry <sup>1)</sup>	Ingress protection	Cap	Surface finish <sup>2)</sup>
<b>BSZ</b>	Aluminium	M20 x 1.5	IP65	Hinged cover with cylinder head screw	Blue, painted
<b>BSZ-K</b>	Plastic	M20 x 1.5	IP65	Hinged cover with cylinder head screw	Plastic
<b>BSZ-H</b>	Aluminium	M20 x 1.5	IP65	Hinged cover with cylinder head screw	Blue, painted
<b>BSS</b>	Aluminium	M20 x 1.5	IP65	Hinged cover with clip	Blue, painted
<b>1/4000 F</b>	Aluminium	½ NPT	IP66 <sup>3)</sup>	Screw cover	Blue, painted
<b>1/4000 S</b>	Stainless steel	½ NPT	IP66 <sup>3)</sup>	Screw cover	Blank
<b>5/6000 F</b>	Aluminium	3 x M20 x 1.5	IP66 <sup>3)</sup>	Screw cover	Blue, painted
<b>7/8000 W</b>	Aluminium	M20 x 1.5	IP66 <sup>3)</sup>	Screw cover	Blue, painted
<b>7/8000 S</b>	Stainless steel	½ NPT	IP66 <sup>3)</sup>	Screw cover	Blank
<b>DIH10/ BSZ-H</b>	Aluminium	M20 x 1.5	IP65	Hinged cover with cylinder head screw and LED indicator DIH10	Blue, painted with indicator

1) Standard, others on request

2) RAL 5022

3) Suitable seal/cable gland required

## Field temperature transmitter (option)

### Field temperature transmitter, model TIF50

As an alternative to the standard connection head, the sensor can be fitted with an optional model TIF50 field temperature transmitter.

A remote version for tube/surface mounting for the sensor designs with connection cable is also possible. The field temperature transmitter comprises a 4 ... 20 mA/HART® protocol output and is equipped with an LCD indication module.



Field temperature transmitter

Fig. left: model TIF50, head version

Fig. right: model TIF50, wall mounting

## Connection head with digital indicator (option)

### Connection head with digital indicator, model DIH10

As an alternative to the standard connection head, the thermometer can be fitted with an optional DIH10 digital indicator.

For operation, a 4 ... 20 mA transmitter is needed, which is mounted to the measuring insert. The indication range is factory configured to the measuring range of the transmitter.



Connection head with digital indicator, model DIH10

## Transmitter (option)

A transmitter can be mounted directly into the connection head.

The following installation variants are thus possible:

- Mounted instead of terminal block
- Mounted within the cap of the connection head
- Mounting not possible

Connection head	Transmitter model	
	T32	T53
BSZ/BSZ-K	○	○
BSZ-H	●	●
BSS	○	○
1/4000	○	○
5/6000	○	○
7/8000	○	○
DIH10	○	-

Model	Description	Explosion protection	Data sheet
T32	Digital transmitter, HART® protocol	Optional	TE 32.04
T53	Digital transmitter FOUNDATION™ Fieldbus and PROFIBUS® PA	Standard	TE 53.01
TIF50	Digital field temperature transmitter, HART® protocol	Optional	TE 62.01

## Design and installation

WIKA uses trained specialists to customise the temperature measuring points to the application. These specialists utilise best practices derived from scientific properties to optimise the life and accuracy of the thermocouple. They make suggestions to optimise the system for temperature, movement, and burner firing.

Some design considerations that can help determine measuring points for the specific application in order to choose the best suitable product:

- Material compatibility with furnace tube
- Heat transfer (radiation, convection, conduction)
- Junction (grounded, ungrounded)
- Thickness of the mineral-insulated cable (flexibility vs. durability)
- Expansion loops (location and design)
- Flame impingement
- Furnace exit design options
- Burner fuel (flue gas composition)
- Welding procedure (TIG, stick, temperature monitoring)
- Mounting (location, orientation)
- Operating vs. design temperatures
- Bending radius
- Path to furnace wall
- Tube clips (location and routing)
- Connection head (material, location, approvals)
- Furnace design (burner locations)

## Expansion loops

Expansion loops should be designed to account for maximum tube movement from startup position to operating temperature. Loops should be designed in accordance with allowable space available.

Examples of expansion loops:

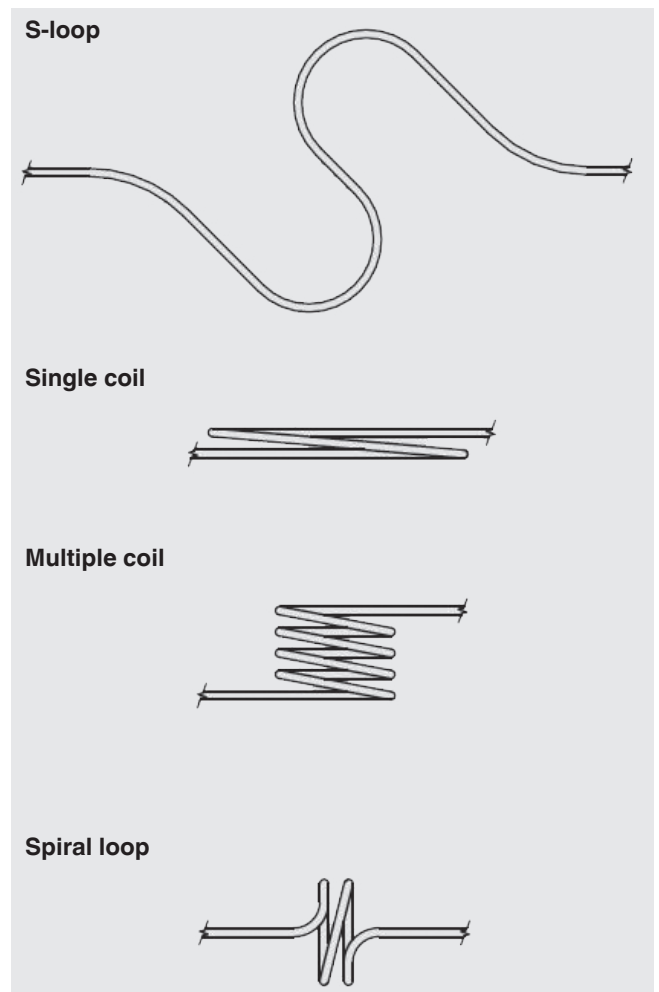

## Electrical connection

### Ceramic terminal block

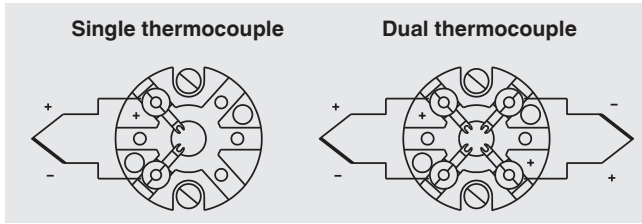

### Crastin terminal block

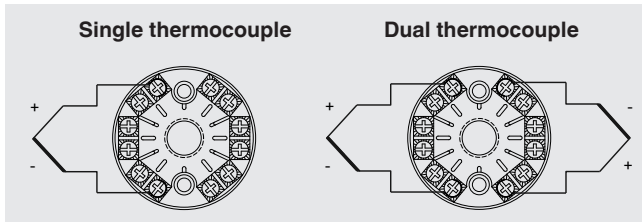

The colour coding at the positive connection to the instruments always decides the correlation of polarity and connection terminal.

For the electrical connections of built-in temperature transmitters as well as for pin assignment of the model TIF50 field temperature transmitter with digital indicator see the corresponding data sheets or operating instructions.

### Cable connection

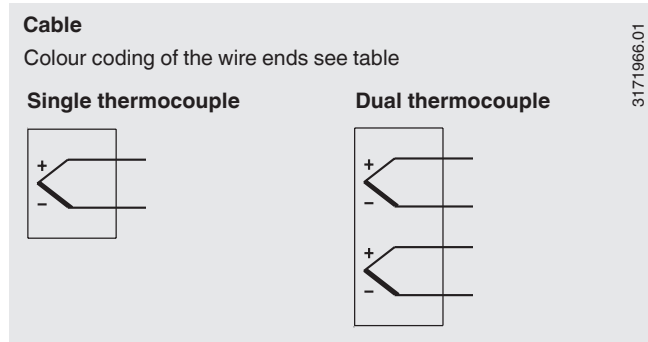

### Colour code of cable

#### ■ IEC 60584-3

Thermocouple type	Positive leg	Negative leg
K	Green	White
J	Black	White
E	Violet	White
N	Pink	White

#### ■ ASTM E230

Thermocouple type	Positive leg	Negative leg
K	Yellow	Red
J	White	Red
E	Violet	Red
N	Orange	Red

## Explosion protection (option)

Thermocouples of the TC59 series are available with an EC-type examination certificate for "intrinsically safe", Ex i, ignition protection.

These instruments comply with the requirements of the ATEX directive for gas and dust.

The classification/suitability of the instrument (permissible power,  $P_{max}$ , as well as the permissible ambient temperature) for the respective category can be seen on the EC-type examination certificate and in the operating instructions.

Built-in transmitters have their own EC-type examination certificate. The permissible ambient temperature ranges of the built-in transmitters can be taken from the corresponding transmitter approval.

The internal inductance ( $L_i$ ) and capacitance ( $C_i$ ) for cable probes are found on the product label and they should be taken into account when connecting to an intrinsically safe power supply.









Thermocouples of the TC59 series are also available with a CSA or FM certificate, Class I Division 1 or Class I Division 2 depending on the style.

For assemblies supplied with a WIKA termination head and flame path, Class I Division 1 may be applicable.

For assemblies supplied with a WIKA termination head and flexible armour, Class I Division 2 may be applicable.

Consult WIKA for your explosion protection requirements.

## Approvals

Logo	Description	Country
	<b>EU declaration of conformity</b> <ul style="list-style-type: none"> <li>EMC directive <sup>1)</sup> EN 61326 emission (group 1, class B) and interference immunity (industrial application)</li> <li>ATEX directive (option) Hazardous areas II 2 G Ex ia IIC</li> </ul>	European Union
		
	<b>IECEx (option)</b> Hazardous areas	International
	<b>FM (option)</b> Hazardous areas	USA
	<b>CSA (option)</b> <ul style="list-style-type: none"> <li>Safety (e.g. electr. safety, overpressure, ...)</li> <li>Hazardous areas</li> </ul>	Canada
	<b>EAC (option)</b> <ul style="list-style-type: none"> <li>EMC directive</li> <li>Hazardous areas</li> </ul>	Eurasian Economic Community
	<b>INMETRO (option)</b> <ul style="list-style-type: none"> <li>Metrology, measurement technology</li> <li>Hazardous areas</li> </ul>	Brazil
	<b>NEPSI (option)</b> Hazardous areas	China
	<b>KCs - KOSHA (option)</b> Hazardous areas	South Korea
-	<b>PESO (option)</b> Hazardous areas	India

1) Only for built-in transmitter

## Certificates (option)

- 2.2 test report
- 3.1 inspection certificate
- DKD/DakS calibration certificate

Approvals and certificates, see website

## Accessories

Description	
<b>Tube clips</b> Material: Stainless steel 310 or Inconel 600®	
	MI cable Ø 6.0 ... 6.4 mm (¼")
	MI cable Ø 7.9 mm (5/16")
	MI cable Ø 9.5 mm (3/8")

Other materials on request

## Ordering information

Model / Explosion protection / Connection head / Cable entry / Terminal block, transmitter / Design of thread / Measuring element / Sensor type / Temperature range / Probe diameter / Pipe diameter / Materials / Thread size / Connection cable, sheath / Lengths N, W, A / Options

© 03/2016 WIKA Alexander Wiegand SE & Co. KG, all rights reserved.  
The specifications given in this document represent the state of engineering at the time of publishing.  
We reserve the right to make modifications to the specifications and materials.

