

**High Pressure Controller, Model CPC8000-H**

GB



**High Pressure Controller, Model CPC8000-H**

**Operating Instructions Model CPC8000-H Page 1 - 87**

**Further languages can be found at [www.wika.com](http://www.wika.com).**

© WIKA Alexander Wiegand SE & Co. KG 2014

Prior to starting any work, read the operating instructions!  
Keep for later use!

Vor Beginn aller Arbeiten Betriebsanleitung lesen!  
Zum späteren Gebrauch aufbewahren!

14235993.00/06/2017/GB

## Content

Content .....	3
1. General information .....	4
2. Safety .....	6
3. Specifications .....	10
4. Design and function .....	13
5. Transport, packaging and storage .....	24
6. Installation and commissioning .....	25
7. Operation .....	27
8. Remote Operation .....	55
9. Calibration .....	72
10. Maintenance, cleaning and service .....	77
11. Faults .....	81
12. Dismounting, return and disposal .....	82
13. Appendix .....	83

### 1. General information

- The high- end pressure controller model CPC8000-H described in the operating instructions has been designed and manufactured using state-of-the-art technology.  
All components are subject to stringent quality and environmental criteria during production. Our management systems are certified to ISO 9001 and ISO 14001.
- These operating instructions contain important information on handling the CPC8000-H. Working safely requires that all safety instructions and work instructions are observed.
- Observe the local accident prevention regulations and general safety regulations, in effect for the instruments range of use. The operating instructions are part of the instrument and must be kept in the immediate vicinity of the CPC8000-H and readily accessible to skilled personnel at any time.
- Skilled personnel must have carefully read and understood the operating instructions, prior to beginning any work.
- The manufacturer's liability is void in the case of any damage caused by using the product contrary to its intended use, non-compliance with these operating instructions, assignment of insufficiently qualified skilled personnel or unauthorized modifications to the CPC8000-H.
- The general terms and conditions (AGB), contained in the sales documentation, shall apply. Subject to technical modifications.
- Factory calibrations/DKD calibrations are carried out in accordance with international standards.
- Further information:

#### **WIKA Alexander Wiegand SE & Co. KG**

- Internet address: [www.wika.de / www.wika.com](http://www.wika.de / www.wika.com)
- Relevant data sheet: CT28.01
- Application consultant: Tel.: (+49) 9372/132-9986  
Fax: (+49) 9372/132-8767  
E-Mail: [info@wika.de](mailto:info@wika.de)

#### **Mensor Corporation**

- Internet address: [www.mensor.com](http://www.mensor.com)
- Relevant data sheet: CT28.01
- Application consultant: Tel.: (+1) 512-396-4200  
(+1) 800-984-4200  
Fax: (+1) 512-396-1820  
E-Mail: [sales@mensor.com](mailto:sales@mensor.com)

## 1. General information

### 1.1 Explanation of symbols



**DANGER!**

... indicates a directly dangerous situation, resulting in serious injury or death, if not avoided.



**WARNING!**

... indicates a potentially dangerous situation, which can result in serious injury or death, if not avoided.



**CAUTION!**

... indicates a potentially dangerous situation, which can result in light injuries or damage to equipment or the environment, if not avoided.



**Information**

... points out useful tips, recommendations and information for efficient and trouble-free operation.



**DANGER!**

...identifies hazards caused by electric power. Should the safety instructions not be observed, there is a risk of serious or fatal injury.

### 1.2 Abbreviation

Abbreviation	Description
FS	Full Span
DUT	Device Under Test

## 2. Safety



### WARNING!

Before installation, commissioning and operation, ensure that the appropriate instrument has been selected in terms of measuring range, design and specific measuring conditions.

Serious injuries and/or damage can occur should these not be observed.



Further important safety instructions can be found in the individual chapters of these operating instructions.

### 2.1 Intended use

The CPC8000-H is designed to automate the testing and calibration of all types of pressure devices and instruments. Up to two removable / interchangeable pressure transducers are available in full scale (FS) ranges from 0 ... 414 bar abs up to 1600 bar abs./ 0 ... 6000 psi abs up to 23200 psi abs. Each transducer module is configured with its own calibration parameters on board and has an accuracy down to 0,01% FS

The two transducers, in combination with the internal control valve regulator, provide a dynamic output. The system consists of a priming system as well as a fluid reservoir. The operator can select a specific transducer. There is no Autorange function. The two ranges can be chosen to optimize uncertainty levels across the full pressure span of the instrument.

In addition to the capacity for two pressure ranges, a third, barometric transducer is installed. With this sensor a CPC8000-H, with absolute or gauge pressure transducers, can emulate pressure of the opposite type.

The instrument has been designed and built solely for the intended use described here, and may only be used accordingly.

The technical specifications contained in these operating instructions must be observed. Improper handling or operation of the instrument outside of its technical specifications requires the instrument to be shut down immediately and inspected by an authorized WIKA service engineer.

Handle electronic precision measuring instruments with the required care (protect from humidity, impacts, strong magnetic fields, static electricity and extreme temperatures, do not insert any objects into the instrument or its openings). Plugs and sockets must be protected from contamination.

If the instrument is transported from a cold into a warm environment, the formation of condensation may result in the instrument malfunctioning. Before putting it back into operation, wait for the instrument temperature and the room temperature to equalize.

The manufacturer shall not be liable for claims of any type based on operation contrary to the intended use.

### 2.2 Personnel qualification



**WARNING!**  
**Risk of injury should qualification be insufficient!**

Improper handling can result in considerable injury and damage to equipment.

- The activities described in these operating instructions may only be carried out by skilled personnel who have the qualifications described below.
- Keep unqualified personnel away from hazardous areas.

#### Skilled personnel

Skilled personnel are understood to be personnel who, based on their technical training, knowledge of measurement and control technology and on their experience and knowledge of country-specific regulations, current standards and directives, are capable of carrying out the work described and independently recognizing potential hazards.

Special operating conditions require further appropriate knowledge, e.g. of aggressive media.

### 2.3 Personal protective equipment

The personal protective equipment is designed to protect the skilled personnel from hazards that could impair their safety or health during work. When carrying out the various tasks on and with the instrument, the skilled personnel must wear personal protective equipment.

The required personal protective equipment must be provided by the operating company.



**Wear safety goggles!**  
Protect eyes from liquid splashes.

### 2.4 Special hazards



**DANGER!**  
Danger of death caused by electric current Upon contact with live parts, there is a direct danger of death.

- Electrical instruments may only be installed and mounted by skilled electrical personnel.



**WARNING!**  
Residual media in dismantled CPC8000-H may result in a risk to people, the environment and the system. Take sufficient precautionary measures.

Do not use this precision pressure controller model CPC8000-H in safety or Emergency Stop devices. Incorrect use of the instrument can result in injury.

Should a failure occur, media under high pressure may be present at the CPC8000-H.



**WARNING!**  
**POSSIBLE INJURY!** The tubing, valves and other apparatus attached to the instrument must be adequate for the maximum pressure which will be applied, otherwise physical injury to the operator or bystanders is possible.



**WARNING!**  
**HIGH PRESSURE!** High pressure gases are potentially hazardous. Energy stored in these gases can be released suddenly and with extreme force. High pressure systems shall be assembled and operated only by personnel who have been trained in proper safety practice.



**CAUTION**  
Use the proper pressure medium. Use only clean, dry noncorrosive gases, air or nitrogen. This instrument is not designed for oxygen use.

## 2. Safety



### WARNING





Do not use detachable mains power supply cord with inadequate ratings. Use the originally delivered mains power supply cord only! If not possible, please contact us or use a certified power cord with ratings according section 3.

GB

## 2.5 Labeling / safety marks

### 2.5.1 Product label

#### 2.5.1.1 CPC8000-H

CPC8000-H High pressure controller

System consists of the following parts:





CPC8000-HC Pressure controller  
(for further information see separate Label on the instrument)

CPC8000-HM Hydraulic controller  
(for further information see separate Label on the instrument)

WIKA, Alexander Wiegand Strasse, 63911 Klingenberg, Germany



#### 2.5.1.2 Pneumatic pressure controller CPC8000-HC

CPC8000-HC pressure controller for CPC8000-H

Power supply: AC 100... 120 V / AC 200 ... 240 V, 50 ... 60 Hz

Energy consumption: max 130 VA

Pressure Medium: clean dry air or nitrogen

Operating temp. : 15 ... 45°C

Serial number: xxxxxx





Pressure rating: MPSVR (0 ... 70 bar)

Date of manufacturing: MM/YYYY

Mensor Corporation - 201 Barnes Drive - San Marcos, TX 78666



#### 2.5.1.3 Hydraulic module CPC8000-HM

CPC8000-HM hydraulic module for CPC8000-H

Pressure Medium Supply/Drive Air Port: clean dry air or nitrogen

Pressure Medium Measure/Control Port:

Operating temp. : 15 ... 40°C

Serial number: xxxxxx

Pressure rating: xxx

Sensor 1: 0 ... 1600 bar, 0,014%FS

Sensor 2: 0 ... 400 bar, 0,01% FS

Date of manufacturing: MM/YYYY

WIKA, Alexander Wiegand Strasse, 63911 Klingenberg, Germany



14235993.00/06/2017/GB



### 2.5.2 Explanation of symbols



Before mounting and commissioning the instrument, ensure you read the operating instructions!



#### **CE, Communauté Européenne**

The CPC8000-H bearing this mark comply with the relevant European directives.



This marking on the instruments indicates that they must not be disposed of in domestic waste. The disposal is carried out by return to the manufacturer or by the corresponding municipal authorities. See directive 2002/96/EC.

## 2.6 European radio frequency emission notice

### 2.6.1 EN 55011 (or CISPR 11)



#### **WARNING!**

This is a class A emission device intended for operation in an industrial environment. It can cause interference under certain circumstances if operated in other environments e.g. residential or commercial areas. The operator may have to take appropriate corrective measures.



#### **INFORMATION**

Do not connect wires longer than 3 m/ 10 ft to the instrument!

### 3. Specifications

GB

## 3. Specifications

### Reference pressure sensors

<b>Type CPR8050</b>	Standard	
Accuracy	0,01% FS	
Gauge pressure	0 ... 400 bar up to 0 ... 700 bar 0 ... 6000 psi up to 0 ... 10000 psi	
Precision	0,005% FS	
<b>Type CPR8850</b>	Standard	Extended
Accuracy	0,01% FS	0,014% FS
Gauge pressure	0 ... 480 bar up to 0 ... ≤1030 bar 0 ... 7000 psi up to 0 ... ≤15000 psi	0 ... 1030 bar up to 0 ... 1600 bar 0 ... 15000n psi up to 23000 psi
Precision	0,005% FS	0,007%FS

### CPC8000-HM

<b>Instrument</b>	
Instrument Version	standard: 19" rack-mounting with side panels incl. rack-mounting kit optional: installed in a 19" rack together with pressure controller CPC8000-HC
Dimensions in mm	see technical drawings
Weight	approx. 87,5 kg approx.. 193 lb
<b>Connections</b>	
Pressure connections	Drive Air Port: 6 mm Swagelok tube fittings Supply Port: 6 mm Swagelok tube fittings Measure/Control Port: ¼" SNOTRIK® tube fittings
Permissible pressure media	Drive Air Port: dry, clean air or nitrogen Supply Port: dry, clean air or nitrogen Measure/Control Port: non-aggressive liquids
<b>Permissible pressure</b>	
Drive Air Port (from CPC8000-HC)	8 ... 35 bar 116 ... 508 psi
Supply Port	10 ... 35 bar 145 ... 508 psi
Measure/Control Port DUT	max. 105 % FS
<b>Control parameters</b>	
Control stability	< 0,005 % FS/sec
Control speed	< 60 s
Control range	20 bar up to end value 200 psi up to end value
Test volume	10 ... 1.000 ccm
<b>Permissible ambient conditions</b>	
Operating temperature	15 ... 40 °C 59 ... 104 °F
Storage temperature	5 ... 70 °C 41 ... 158 °F
Relative humidity	0 ... 95 % r.H. (non-condensing)
Compensated temperature range	15 ... 40 °C 59 ... 104°F
Mounting position	horizontal

### CPC8000-HC

<b>Instrument</b>	
Instrument version	standard: 19" rack-mounting with side panels incl. rack-mounting kit optional: installed in a 19" rack together with hydraulics module CPC8000-HM
Warm-up time	approx. 25 min
Dimensions in mm	see technical drawings
Weight	approx. 21 kg approx. 46,3 lb
<b>Display</b>	
Screen	9.0" color TFT with touch-screen
Resolution	4 ... 7 Digits
Input methods	capacitive touch-screen

### 3. Specifications

<b>Connections</b>	
Pressure connections	7/16"-20 F SAE
Pressure adapters	6 mm SWAGELOK® threaded pipe connection; others on request
Filter elements	all pressure ports have 20-micron filters
Permissible pressure media	dry, clean air or nitrogen
Overpressure protection	safety relief valve
<b>Permissible pressure</b>	
Supply Port	8 ... 35 bar
Measure/Control Port	max. 105 % FS
<b>Spannungsversorgung</b>	
Power supply	AC 100 ... 120 V / 200 ... 240 V, 50 ... 60 Hz
Power consumption	130 VA
<b>Permissible ambient conditions</b>	
Operating temperature	15 ... 45 °C
	59 ... 113 °F
Storage temperature	5 ... 70 °C
	41 ... 158 °F
Relative humidity	0 ... 95 % r.H. (non-condensing)
Compensated temperature range	15 ... 45 °C
	59 ... 113 °F
Mounting position	horizontal
<b>Communication</b>	
Interface	IEEE-488.2, Ethernet, USB, RS-232
Command sets	Mensor, WIKA SCPI
Response time	< 100 ms

GB

### CE conformity, approvals, certificates CPC8000-H

<b>CE conformity</b>	
EMC directive <sup>1)</sup>	2004/108/EC, EN 61326-1 emission (group 1, class A) and interference immunity (industrial application)
Low voltage directive	2006/95/EC, EN 61010-1
<b>Approvals</b>	
<b>Zertifikat</b>	
Certificate <sup>2)</sup>	Standard: 3.1 calibration certificate per EN 10204 Option: DKD/DAkkS calibration certificate

<sup>1)</sup> Warning! This is class A equipment for emissions and is intended for use in industrial environments. In other environments, e.g. residential or commercial installations, it can interfere with other equipment under certain conditions. In such circumstances the operator is expected to take the appropriate measures.

<sup>2)</sup> Calibration in a horizontal position.

Approvals and certificates, see website

For further specifications see WIKA Data Sheet CT 27.05 and the order documentation.

14235993.00/06/2017/GB

### 3. Specifications

#### Dimensions in mm

GB

Front view

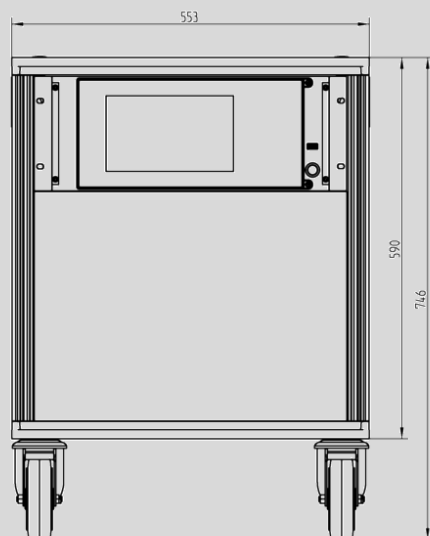

Side view

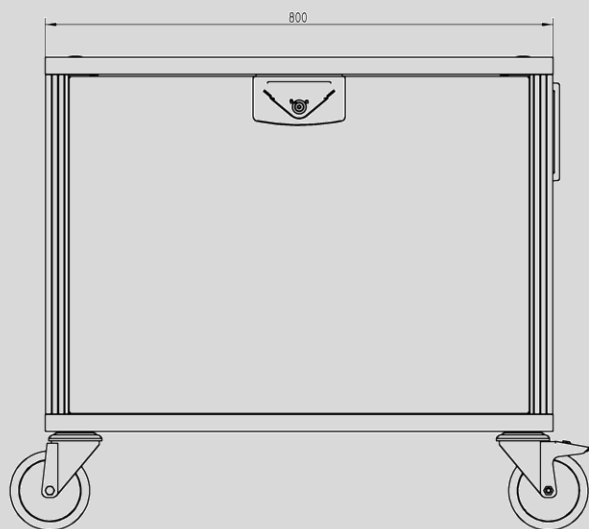

\*(casters are optional available)

14235993.00/06/2017/GB

### 4. Design and function

#### 4.1 Short description

The high pressure controller CPC8000-H consists of two parts, a pneumatic pressure controller CPC8000-HC and a hydraulic module with reference pressure sensors CPC8000-HM.

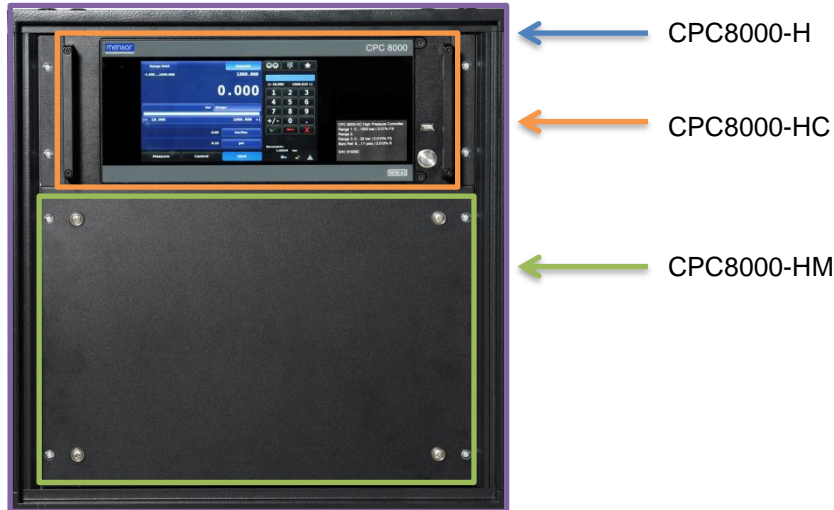

The high pressure controller CPC8000-H is a multi-sensor pressure controlling system designed to test and calibrate a variety of pressure devices in either absolute or gauge pressure modes. The instrument is able to have up to two interchangeable reference pressure sensors and a interchangeable barometric reference. There are several languages, standard interfaces like RS-232, USB, Ethernet and IEEE available.

#### 4.2 Functions

Here is a short list of significant features designed into the CPC8000H:

1. Up to two, highly stable removable / interchangeable pressure transducers. Each transducer is a totally self-contained module including its unique calibration data.
2. An high performance Barometer module can be used for accurate emulation of gauge pressure with absolute pressure instruments, or used for absolute pressure emulation with gauge pressure instruments.
3. A large 9- inch diagonal color LCD display with glass capacitive touch screen for intuitive operator interface.
4. A very quiet precision pressure regulator with a fast response time.
5. Multiple languages.



Operate the CPC8000-H while it is either mounted on a bench or in a standard equipment rack. Use either front panel input (7 Operation), or send commands and queries over a bus from a separate "host" controller (8 Remote Operation).

### 4.3 Front Panel

The front of the CPC8000-H has a smooth, uncluttered appearance. Its main feature is the large color display plus an identification label in the lower right corner of the display panel. The display panel is hinged for easy access to remove or replace the transducer modules inside. The instructions for accessing the transducers are provided in Section 10.4.1 CPC8000-HM Transducer Removal / Replacement. Immediately to the right of the display panel is a USB port and a power switch.



Figure 4-1 Front Panel

### 4.4 CPC8000-HC

#### 4.4.1 Power switch

The power switch is a two-state device with an action similar to that of a ball point pen. Push the button with enough force to latch it in to turn the unit ON. Push it again to release it to turn the system OFF.



**INFORMATION!**

If power to the instrument is interrupted while ON it will shut down until the power is restored, then immediately resume operation.



**INFORMATION!**

The power switch is the mains disconnecting device.

#### 4.4.2 USB Port

The front panel USB port is the same as the Host USB port on the rear panel. Both are intended for future expansions or software upgrades.

#### 4.4.3 Information Label

The front panel label identifies the instrument name, installed transducer ranges in the pressure units specified by the customer, and the serial number.

#### 4.4.4 Screen

The large (9 inch diagonal) HD-LCD color screen has a glass capacitive touch screen for navigation within the intuitive operator interface. At power up the main screen is presented.

##### 4.4.4.1 Main Screen Features

On power up, the main screen will show a numeric data entry key pad on the right 1/3 of the display and pressure range, control and operating parameters on the left 2/3.

The data entry key pad can be switched between 4 different methods for data entry. See Section 7 Operation, for more details. The data entry portion of the main screen is used primarily to input and adjust control set points and change main screen parameters. The left 2/3 of the main screen (see Figure 4-2 Main screen description) contains the reading of the internal pressure sensor, current

## 4. Design and function

configuration settings, range limits and labels (see Section 7 Operation, for more details). Pressure monitoring calibration and testing functions are performed through interaction with this screen.

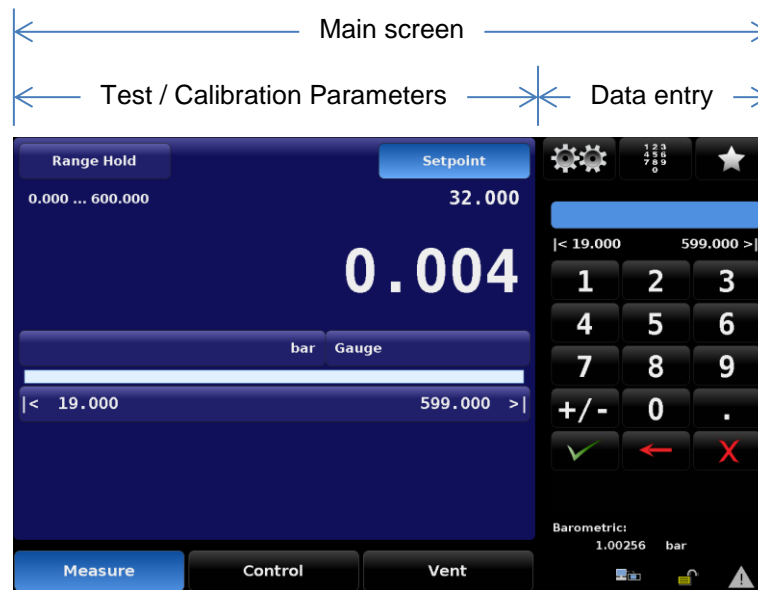





Figure 4-2 Main screen description

Individual screens are accessed by a series of touches on tabs, buttons or icons, which open screens within the hierarchy of the instrument. Nomenclature that designated a screen and how to navigate to it will be given in this manual in the following structure: “Icon name” [Icon Graphic] / [Tab] / [Button Name]. For example the screen used to set the resolution of the instrument sensor would be designated by the navigational screen hierarchy, starting from the main screen, as follows: Setup [  ] / [Sensor] / [Resolution]. This convention is similar to a computer folder system and will be used to describe a screen and, inherently, how to navigate to it. All of the screens are set up into two display areas. The larger area (left 2/3 of the screen) shows live information about the current configuration, the progress of the test being performed and gives an indication of the output of the device. The smaller area (Data Entry) on the right side, has the number key pad, variable sliders or discrete choice buttons (radio buttons) that all act to input alpha numeric information or mode changes relating to the test or calibration information being shown on the left.

Buttons on the screen are shown with a gradient background. When inactive the buttons are shown with the gradient dark on the bottom and light on the top; when selected the button changes color and is light on the bottom and dark on the top. Buttons are labeled in an intuitive fashion and when selected its function is obvious.

The setup screens are accessed by pressing the double gear icon [  ] and follows the same format as the main screen with the right hand side used for data entry and the left hand side used for display. These setup screens are used for a variety of instrument settings, including, display, sensor, control, and remote interface settings. This area also contains the application used to calibrate the internal sensors plus various administrative, information and configuration settings. Detailed information about all setup screens can be found in Section 7 Operation.

Touch the left pointing arrow [  ] in the bottom left corner of any setup screen to return to the main screen.

Full operational descriptions of all of the screens, symbols, labels and switches are provided in Section 7 Operation.

### 4.4.5 Barometric Reference Transducer

This optional transducer allows gauge mode instruments to operate in absolute mode, and similarly, absolute mode instruments to operate in gauge mode. Changing modes is easily accomplished from the front panel or over the remote interface.

In use the active channel of the CPC8000-H will either add or subtract the measurement of the installed barometric reference sensor to accomplish the appropriate emulation.

## 4. Design and function

The barometric reference sensor has six significant digits.

### 4.4.5.1 Specifications

Optional barometric reference	
Range	552 ... 1170 mbar abs. 8 ... 17 psi abs
Accuracy	0,01 % of reading
Resolution	6 Digits

### 4.4.5.2 Pressure Mode

The Pressure [Mode] key is shown on the main menu screen below the current pressure value and displays the most recently chosen pressure units and the mode (absolute or gauge). If the optional barometric reference is installed a [Mode] key replaces the mode indication to the right of the units key. This [Mode] key indicates absolute or gauge mode. When the key is pressed it will switch between the "native mode" of the internal sensor to the emulation mode. The "native mode" is the mode of the sensor that is installed and is either absolute or gauge. Emulation mode uses the value of the barometric reference to emulate the mode that is alternate to the native mode. The CPC8000-H can emulate gauge from a native absolute sensor or absolute from a native gauge sensor. The [Mode] key indicates the native mode with a blue key background and emulation mode with a light blue key background. The units and mode chosen remain the same when the CPC8000-H is turned off and then back on.



Native sensor is gauge, no barometric reference installed.

Native sensor is gauge, barometric reference installed.

Native sensor is gauge, barometric reference installed and absolute emulation active.

#### 4.4.5.2.1 Gauge emulation mode

In the gauge emulation mode the atmospheric pressure reading from the barometric reference transducer is subtracted from the absolute pressure reading of the active channel to emulate a gauge pressure. Emulation mode uncertainty is the combined uncertainty of the barometric reference transducer and the active transducer.

#### 4.4.5.2.2 Absolute emulation mode

In absolute emulation mode the atmospheric pressure reading from the barometric reference transducer is added to the gauge pressure reading of the active channel to emulate absolute pressure. Emulation mode uncertainty is the combined uncertainty of the barometric reference transducer and the active transducer.



## 4. Design and function

### 4.5 Rear Panel

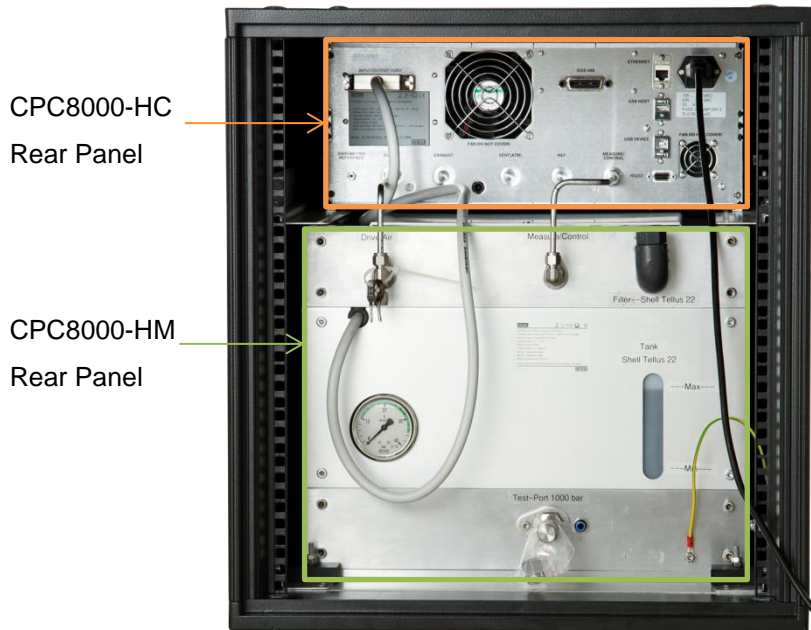

GB

#### 4.5.1 CPC8000-HC Rear Panel

Up to five pneumatic pressure ports are located on the rear panel. To the right of the pressure ports are the Ethernet, RS-232 and USB connectors and the power plug. The CPC8000-HM communications connector as well as the IEEE connector are located above the pressure ports.

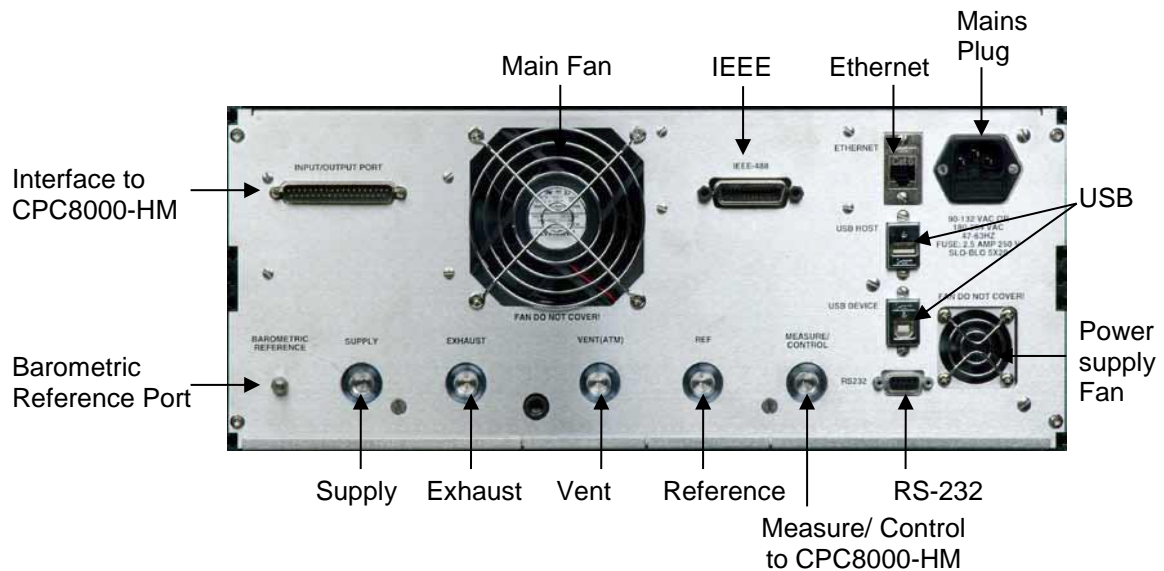

Figure 4-3 Rear panel description

14235993.00/06/2017/GB

## 4. Design and function

### 4.5.1.1 Pressure Ports



#### WARNING!

The pressure connections must be installed according to the following instructions, observing the relevant regulations. The installation is to be performed by trained, authorized personnel, knowledgeable in the safety regulations for working on pneumatic systems.



#### INFORMATION

Up to 6 pressure connections are on the rear panel. Pressure connections that are not assigned are plugged.

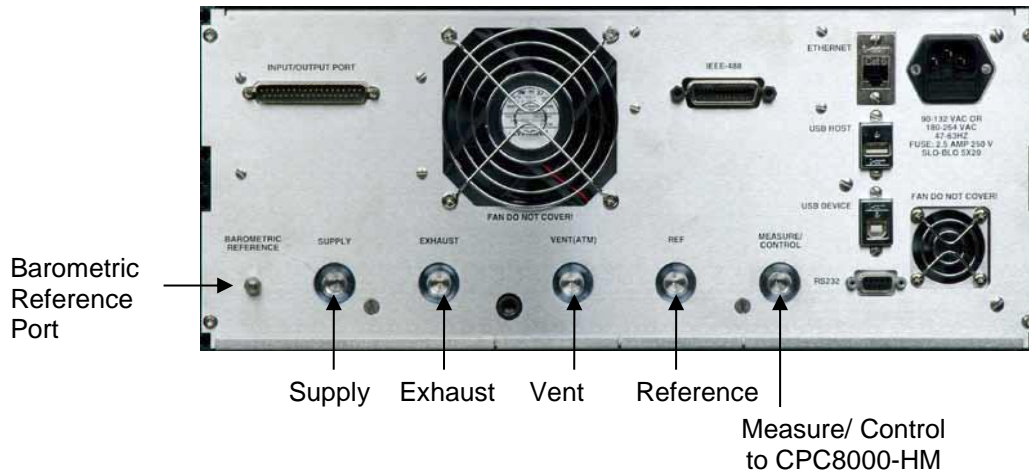

Figure 4-4 Rear panel pneumatic connection

All of the primary pressure ports on the rear are female 7/16 - 20 SAE/MS straight threads per MS16142 and SAE J514 table 14. They require a tube fitting boss seal with an o-ring per MS33656. WIKA/Mensor provides different adaptors with the ordered instrument depending on the options selected. The following adaptors are available:

- 6 mm male tube fittings
- 1/4" tube fittings
- 1/8" female NPT
- 1/8 female BSPG

The pressure connections can be made to these adapters with the proper mating hardware. Do not use sealant on fittings sealed with an o-ring. The integrity of each seal is particularly important since even microscopic leaks can cause errors in pressure measurements.



#### INFORMATION

For functional testing and to become familiar with the operation of the CPC8000-HC, a volume close to the volume expected during normal operation can be connected to the Measure / Control port.



#### WARNING!

The user must ensure that released pressure medium does not endanger personnel, environment or the instrument.



#### INFORMATION

Test items with large volumes or long piping runs with small diameter tubing can have a negative effect on the control performance.

14235993.00/06/2017/GB

## 4. Design and function

GB

### ■ Supply Port

The pressure supplied to the pressure connection labeled “Supply” should be approximately 10% higher than the full scale of the highest pressure transducer installed in the controller (see the label on the lower right of the front panel).

### ■ Exhaust Port

Not use in this instrument version. Leave this port open atmosphere.

### ■ Vent Port

The pressure connection labeled “Vent” is the exhaust port where the system pressure is vented to the atmosphere under certain conditions. Leave this port open or connect the optional muffler for noise reduction.

### ■ Reference Port

This is the pressure connection to the reference ports of sensors with ranges <50 psi (4 bar) gauge.



### INFORMATION!

The Reference port should be left open to the atmosphere and should NEVER be connected to a pressure source.

### ■ Measure/Control Port

The Measure/Control port (when in the Control mode) supplies a precisely controlled pressure to the pressure multiplier in the CPC8000-HM which is converted into a hydraulic pressure. In Measure mode a pressure applied to the Measure/Control port is measured by the instrument sensor.

### ■ Barometric Reference

The Barometric Reference port is connected to the internal barometric sensor and should be left open to atmospheric pressure.

The higher the supply pressure connected to the Supply port, the higher the pressure which leaves the system through the exhaust port. If a vacuum pump is connected to the exhaust port, adequate safety precautions have to be taken to prevent damage to the pump.

Before the system is connected, the user must ensure that suitable protection measures are in place which exclude overpressuring of the test piece or the system.

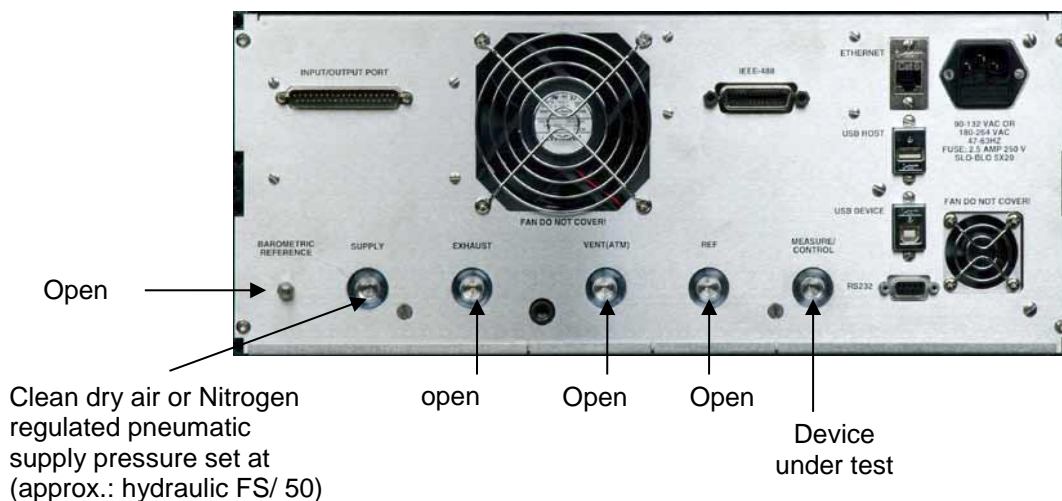

Figure 4-5 recommendation for pneumatic connections

14235993.00/06/2017/GB

## 4. Design and function

### 4.5.1.2 Electrical connection



#### **CAUTION!**

The electrical installation must be done according to the following instructions while observing the relevant regulations. It is to be performed by individuals familiar with the safety regulations for working on electrical connections.



#### **WARNING**

The interface cables must not be longer than 3 meters and must be separate from cables with voltages greater than 60 volts.

### 4.5.1.3 Power supply



#### **WARNING**

Switch off the power of the system CPC8000-H before connecting or disconnecting the power supply. Before connecting to the power supply, make sure that the voltage ratings of the CPC8000-H and the power supply are identical. Connect to power supply with protective earth (PE) connection only!

Use the originally delivered mains power supply cord only! If not possible, please contact us or use a certified power cord with ratings according section 3.

#### 4.5.1.3.1 RS-232

The RS-232 connection on the rear panel of the CPC8000-HC is a female 9-pin sub-d plug. USB to RS-232 adaptors with a virtual com port can be used for communication if there is no RS-232 connection on your PC.

#### 4.5.1.3.2 ETHERNET Interface

The Ethernet communication port allows the CPC8000-HC to communicate with computers using 10/100 Based-T specifications.



#### **CAUTION!**

Please consult your Computer Resources Department prior to connecting this instrument to your network to verify there are no conflicts with existing IP addresses.

Ethernet communications are transmitted over a standard RJ-45 cable. Connecting directly to a PC requires a crossover Ethernet cable. Hub or router connections require a straight Ethernet cable.

Prior to first time use of Ethernet communication, the four parameters, IP, Netmask, Gateway, and Port must be setup. These are configured in the communications setup screen.

#### 4.5.1.3.3 USB Host Interface

The USB Host interface is a service port used to upgrade software and download information from the device. It has the same function as the USB Host port on the front of the CPC8000-HC.

#### 4.5.1.3.4 USB Device Interface

The USB Device jack is a standard USB Type B receptacle interface used for remote communication. The USB Driver can be downloaded at:

[http://www.mensor.com/download\\_software\\_instrument\\_en\\_um.WIKA?ActiveID=31350](http://www.mensor.com/download_software_instrument_en_um.WIKA?ActiveID=31350)

#### 4.5.1.3.5 IEEE-488 Interface (GPIB)

The connection of the IEEE-488 interface is designed as a 24-pin IEEE-488-socket.

The manufacturer of the host IEEE-488 interface board provides software to allow communication between the board and various programming languages. An interactive program for debugging is usually provided as well. Refer to the board manufacturer's documentation for more information.

## 4. Design and function

### 4.5.2 CPC8000-HM Rear Panel

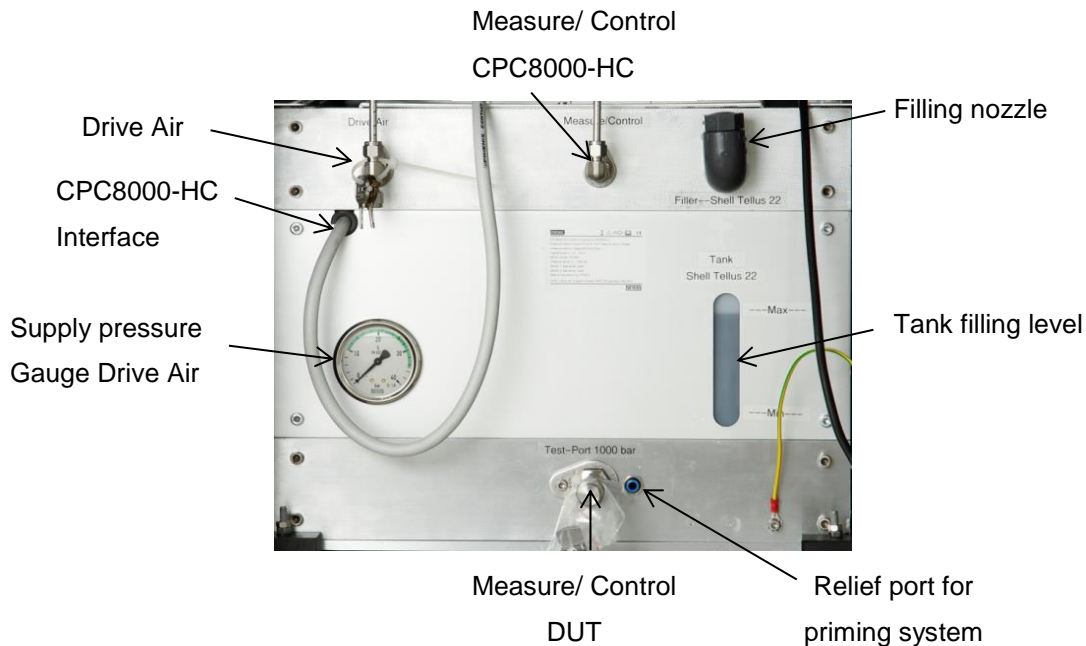

GB

#### 4.5.2.1 Gauge

The gauge shows the applied supply pressure of the Drive Air port

#### 4.5.2.2 Filling level

This part indicates the filling level of the internal reservoir. The tank has a level switch which informs the user that the filling level is too low via the mains screen of the CPC8000-HC.

#### 4.5.2.3 Filling nozzle

Refill the tank over this nozzle and observe the filling level by the window below. Do not fill more than the maximum indicated level in the system.

#### 4.5.2.4 Interface CPC8000-HC

This interface has to be connected to the CPC8000-HC all the time. It is responsible for the transfer of data between the CPC8000-HM and the CPC8000-HC. There are data like the hydraulic reference sensor reading and the limit switch status transferred.

14235993.00/06/2017/GB

## 4. Design and function

### 4.5.2.5 Pressure ports



#### **WARNING!**

The pressure connections must be installed according to the following instructions, observing the relevant regulations. The installation is to be performed by trained, authorized personnel, knowledgeable in the safety regulations for working on pneumatic systems.

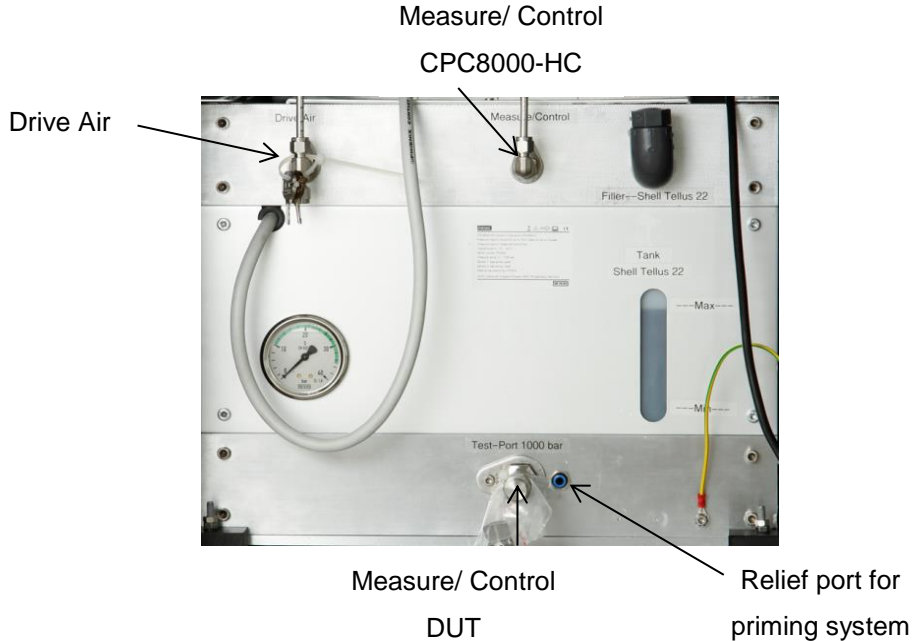

#### **4.5.2.5.1 Drive Air**

The Drive Air Port is used to supply the internal pneumatic controlled valves as well as the priming pump with pressure. There are working pressure regulators installed in order to reduce the pressure internally to the required level. These working pressure regulators have an air consumption.

There are two possible setups to supply this port with pressure:

1. CPC8000-HC and CPC8000-HM together, single supply  
When supplying CPC8000-HC and CPC8000-Hm together with a single pressure source, the supply pressure has to be adjusted to the recommended supply pressure of the CPC8000-HC. (approx.: hydraulic full scale pressure/50)
2. CPC8000-HC separated from CPC8000-HM  
If the CPC8000-HM is supplied separately from the CPC8000-HC, the supply pressure can be up to max. 35 bar/ 500 psi.

#### **4.5.2.5.2 Measure/ Control CPC8000-HC**

The MEASURE/CONTROL CPC8000-HC port is the connection between the pneumatic control pressure from the CPC8000-HC for the multipliers. Depending on the measuring range of the system and setpoint, the pressure can be up to 32 bar/ 465 psi.

#### **4.5.2.5.3 Measure/ Control DUT**

Connect the DUT here. A precise pressure is controller to this port. (when controller is in control mode)



#### **INFORMATION**

For functional testing and to become familiar with the operation of the CPC8000-H, a volume close to the volume expected during normal operation can be connected to the Measure / Control port.

## 4. Design and function



### INFORMATION

Test items with large volumes or long piping runs with small diameter tubing can have a negative effect on the control performance.

### 4.6 Transducer choices

GB

Transducer measuring modes can be gauge or absolute. The CPC8000-H will be equipped with one or two transducers. Transducer type will be CPR8050 "Standard" (uncertainty 0,01% FS) up to 700 bar/ 10000 psi or CPR8850 "Premium" (uncertainty of 0,014% FS down to 0,01%FS) up to 1600 bar / 23200 psi . The transducers "Standard" sensors or all "Premium" sensors are allowed to be mixed of both types. The two sensors, in combination with NVR Module, provide a wide dynamic range. In vent mode, the operator can select one of the two sensors to operate with. The two sensor ranges can be chosen to optimize uncertainty levels. The uncertainty specifications, plus a proprietary control technology, provides accurate and stable control. The transducer CPR8850 is sensitive against sudden pressure peaks or pressure decrease and can be damaged in the worst case.

An precision barometer is used for emulation of gauge pressure with an absolute pressure instrument, or used for absolute pressure emulation with a gauge pressure instrument.

Table 1 Transducer Choices

Transducer 1	Accuracies
CPR8050 Standard sensor	0.01% full scale
CPR8850 Premium sensor	0,014% FS down to 0,01%FS

Transducer 2	Accuracies
CPR8050 Standard sensor	0.01% full scale
CPR8850 Premium sensor	0,014% FS down to 0,01%FS

### 4.7 Scope of delivery

- Pressure Controller Model CPC8000-HC, 19" rack version
- Hydraulics Module Model CPC8000-HM, 19" rack version
- Pneumatic connection between CPC8000-HC and CPC8000-HM, approx.. 1 m/ 3,3 ft
- 2 m/ 6,5 ft power cord
- Operation instructions
- 3.1 calibration certificate per DIN EN 10204

# 5. Transport, packaging and storage

## 5.1 Transport

Check the instrument for any damage that may have been caused by transport.

Obvious damage must be reported immediately.

## 5.2 Packaging

Do not remove packaging until just before mounting.

Keep the packaging as it will provide optimum protection during transport (e.g. change in installation site, sending for repair).

## 5.3 Storage

### Permissible conditions at the place of storage:

- Storage temperature: 0 ... 70 °C
- Humidity: 35 ... 85 % relative humidity (no condensation)

### Avoidance of exposure to the following factors:

Direct sunlight or proximity to hot objects

- Mechanical vibration, mechanical shock (putting it down hard)
- Soot, vapor, dust and corrosive gases
- Potentially explosive environments, flammable atmospheres

Store the CPC8000-H in its original packaging in a location that fulfills the conditions listed above. If the original packaging is not available, package and store the CPC8000-H as described below:

1. Wrap the instrument in an antistatic plastic film.
2. Place the CPC8000-H, along with shock-absorbent material, in the packaging.
3. If stored for a prolonged period of time (more than 30 days), place a bag, containing a desiccant, inside the packaging.



### WARNING!

Before storing the instrument (following operation), remove any residual media. This is of particular importance if the medium is hazardous to health, e.g. caustic, toxic, carcinogenic, radioactive, etc.



### 6. Installation and commissioning

In addition to functional testing, each unit is inspected for appearance prior to leaving the factory. Upon receipt, please examine the transducer for shipping damage. Report any apparent damage to the carrier immediately.

The instrument can be set up on a table top or it can be rack-mounted. The rack mount is optional on the CPC8000-H. The special sensors used in the CPC8000-H are relatively insensitive to tilt and vibration. However to further assure stability and accuracy, avoid mounting the instrument on surfaces subject to excessive motor or machinery vibration.

#### The installation site must meet the following conditions:

- Operating Temperature: 15 to 40 °C
- Humidity: 0 to 95 % relative humidity (non-condensation)
- Flat, horizontal location; secure fixed working surface (desk top model) or installation in a 19" rack mount.
- The power cord is the disconnection device. Its outlet should be accessible and contain a protected earth ground.

#### Avoid the following influences:

- Direct sunlight or proximity to hot objects
- Unstable installation position
- Mechanical vibration
- Proximity to sources of strong electromagnetic fields, such as high tension appliances, mobile telephones or mains
- Soot, steam, dust and corrosive gases
- Environment with explosion hazard, flammable atmospheres



#### WARNING

Switch off the power of the system CPC8000-H before connecting or disconnecting the power supply. Before connecting to the power supply, make sure that the voltage ratings of the CPC8000-H and the power supply are identical. Connect to power supply with protective earth (PE) connection only!



#### WARNING

Use the originally delivered mains power supply cord only! If not possible, please contact us or use a certified power cord with ratings according section 3.

## 6. Installation and commissioning

### 6.1 Turn on the Instrument

After the pressure connections are secure in accordance with Section 4.5, apply power to the power connector on the rear of the instrument and switch the power switch ON. The instrument will go through an initialization process and system check. As soon as the system check is completed the system will default to an operating screen similar to the screen shown in below. Allow the instrument at least 25 minutes of warm up time before performing critical pressure measurements.



#### WARNING

This is an instrument of protection class 1 intended for connection to mains supply with protective earth (ground)! Do not use any power adaptors or surge protection devices that negate the protective earth! The power cord must be accessible and contains a protective earth.

Ventilation! Do not block airflow to ventilating fans located on rear of instrument.

The instrument can be set up on a table top or it can be rack mounted. Rack mount adapters are optional.



Figure 6-1 Main Screen

## 7. Operation

### 7.1 General

This section describes the procedures for operating the CPC8000-H from the front panel. Instructions for operating the instrument from an external computer are covered in section 8. Remote Operation. By following the procedures provided in these two Sections, you can expect your CPC8000-H to deliver maximum accuracy and dependability for many years of exceptional service.

When the instrument is powered on it will take about 30 seconds to boot up. At the end of the boot process the display screen similar to "Figure 7-1 Main screen separation" will appear. This is the main operating screen. At this point the CPC8000-H is ready for operation. However, for critical tests and measurements allow the unit to warm up for at least 25 minutes with power on to ensure rated accuracy.

Notice that the portion of the screen with a blue field covers about two-thirds of the total screen area. This area contains the pressure output reading, the setpoint, the active transducer range, units of measure, limits and a choice between the control modes: Measure, Control or Vent.

The sidebar to the right (black field) is used for entering data, adjusting environmental settings, defining parameters for remote operations, and making choices in the configuration. Several different sidebars can be accessed from the main screen to achieve different objectives.

This section of the manual will explain features of this main operating screen and the associated sidebars.

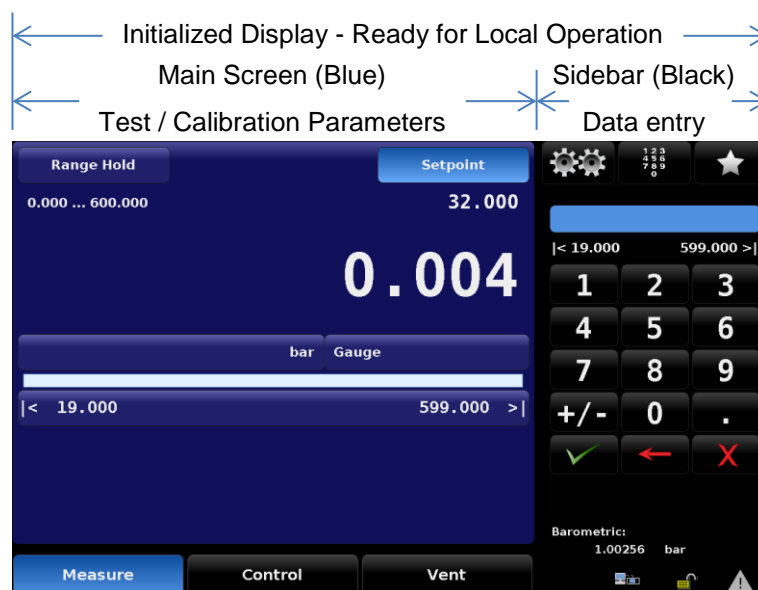

Figure 7-1 Main screen separation

Beyond the main screen are a series of setup screens used to adjust parameters and conditions, such as performing calibrations, running programmed routines, operating from a remote computer, etc. All such setup screens are on black backgrounds, and have their own sidebars (also black) for choice menus and data entry. Explanations and instructions for using these setup screens are covered in Section 7.3 Setup.

#### 7.1.1 Buttons, Keys, Tabs, and other terms

Many of the words and symbols displayed on screen are active touch points, such that when touched or pressed something will change if it is an allowable action. In this manual these touch sensitive points are shown inside brackets such as [Setpoint], the button seen in the upper middle corner of the main screen (see Figure 7-2 Main screen items). Tabs are radio buttons shown along the bottom of

## 7. Operation

most screens and they open other screens related to the activity named on the tab or indicate a selection associated with the active screen.

A touch point will respond with an audible “beep” as a signal of acceptance. A “blap” (error tone) sound is a signal that an illegal action was attempted, such as a number entry beyond the allowable range.

A word or symbol on a screen which does NOT respond to being touched or pressed is referred to in this manual as a label, window, monitor or an indicator.

### 7.2 Main Screen

#### 7.2.1 Map of the Main Screen Features

“Figure 7-2 Main screen items” is a map of the main screen features and reflects a CPC8000 without any of the extra display options. The map includes a title box for each screen feature and the section number of the explanatory text about the feature and its use.

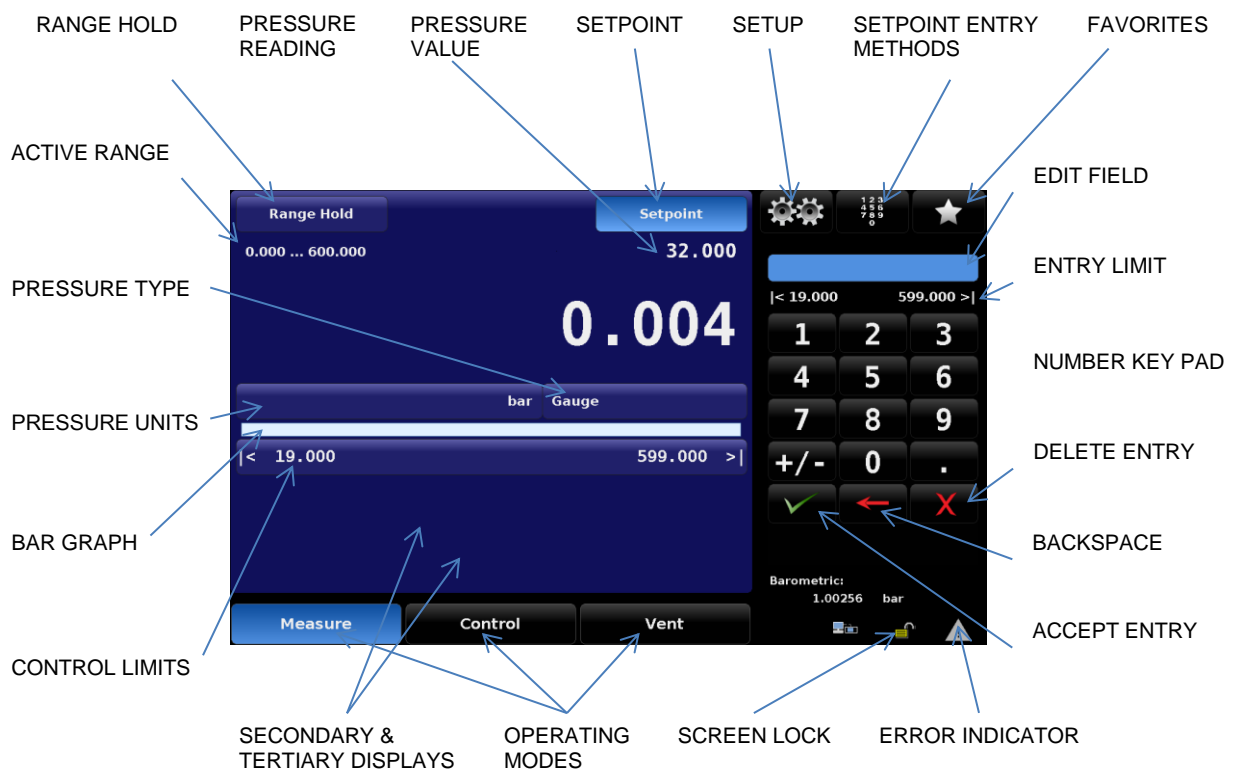

Figure 7-2 Main screen items

## 7. Operation

### 7.2.2 Main Screen Features

The table below is a reference list of the features that appear on the main screen after power up.

Table 2 Reference List of the Main Screen Features

Feature	
Autorange / Range Hold	7.2.3 [Range Hold]
Pressure Reading	7.2.4 Pressure Reading
Setpoint	7.2.5 [Setpoint] Button
Setpoint Value	7.2.6 Setpoint Value
Setup	7.2.8 Setup
Setpoint Entry Methods	7.2.7 Setpoint Entry Methods
Number Key pad	7.2.7.1 Number Key Pad
Delete Entry	7.2.7.1 Number Key Pad
Backspace	7.2.7.1 Number Key Pad
Accept Entry	7.2.7.1 Number Key Pad
Number Pad Step	7.2.7.2 Number Pad / Step
Favorites	7.2.9 Favorites
Screen Lock	7.2.10 Status Bar
Error Indicator	7.2.10 Status Bar
Secondary & Tertiary Displays	7.2.11 Secondary and Tertiary Displays
Limits (Range, Control, and Entry)	7.2.12 Limits
Bar Graph	7.2.13 Bar Graph
Pressure Units	7.2.14 Pressure Units
Pressure Type	7.2.15 Pressure Type
Operating Modes	7.2.16 Operating Modes

GB

### 7.2.3 [Range Hold]

The upper left corner of the main screen shows [Range Hold]. If a second transducer is installed the user is able to choose one of the internal reference pressure transducers with this button. When [Range Hold] is showing the operator has assigned a specific transducer to be the lone, active transducer. In either case the active sensor window immediately below the button will identify, by range, which is the active sensor of the moment.

Press the [Range Hold] button to cause the transducer assignment list to appear in the sidebar. This list will show a table of up to two choices, first or second transducers, by range. The presently active range is highlighted. Touch either one of the listed ranges and that choice is immediately effective. If the CPC8000-H is under pressure, no other transducers is allowed to be chosen.

14235993.00/06/2017/GB



Figure 7-3 Range Hold

## 7.2.4 Pressure Reading

The large, green number displayed in “Figure 6-1 Main Screen” is the pressure reading at the sensor connected to the Measure/Control DUT port. It is green because the sensed pressure is within a user-defined stable window for a user-defined period of time. When the pressure is outside of the stable window, the number will be white. See Section 7.3.3.2 for a detailed explanation and setup of the stable window.



### INFORMATION

The pressure reading will turn red if an external pressure is applied at the Measure/Control port that is 7% greater than the upper limit of the active transducer. Each transducer is supplied with a pressure release valve set for 10% over the calibrated pressure. Inherent internal safeguards are set to prevent overpressure.

## 7.2.5 [Setpoint] Button

The [Setpoint] button will activate a sidebar data entry method to accept a new setpoint value. The setpoint value is displayed in the window just below the [Setpoint] button on the main screen, see Section 6.2.4. The setpoint value can also be adjusted incrementally in the sidebar by use of one of four setpoint entry methods:

- The numeric key pad
- A numeric step value assigned to the up [▲] and down [▼] arrow keys
- A digital step assigned to the up [▲] and down [▼] arrow keys
- A program

Procedures for making changes to the setpoint using these methods are covered in Section 7.2.7 Setpoint Entry Methods.

## 7.2.6 Setpoint Value

The setpoint value window is located immediately under the [Setpoint] button. It displays the current pressure setpoint (target value for the output pressure provided by the internal regulator when in Control mode). To edit the setpoint value, first touch the [Setpoint] button. This will activate the system for setpoint changes. The sidebar will display the default number key pad or a pre-chosen setpoint entry method. To change the setpoint value use one of these methods described in Section 7.2.7.



Figure 7-4 Output pressure setpoint

## 7.2.7 Setpoint Entry Methods

Pressing the key pad icon [  ] in the middle of the top row will display the four line menu as shown below.

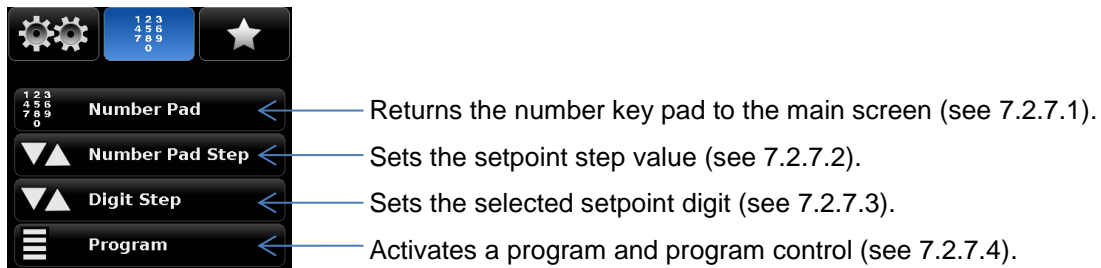
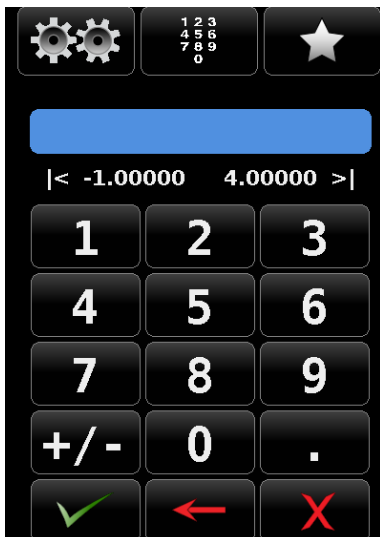



Figure 7-5 Setpoint Entry Methods

### 7.2.7.1 Number Key Pad



The [Number Pad] button provides 10 digits for numeric entry, plus the decimal point and a sign key. The sign key [+/-] will toggle between positive and negative values. Each stroke on the key pad will echo in the blue input value window above the pad. A change between plus and minus values [+/-] can be entered at any time during the string entry. Pressing the Enter [  ] key will accept the value and it will become the new Setpoint.

If the input window holds an illegal value when the [  ] Enter-button is pressed the system will respond with a an error tone and the entry will turn red. When that happens determine the cause of the rejection, delete the entry, and then enter a valid number.

Pressure limits are shown above the key pad and indicate the allowable range for entry. This is either the range of the active sensor, the full range of the instrument (when in Autorange mode) or the range limits set in the setup controls limits menu (see Section 7.3.3.1 Max and Minimum Limits).

14235993.00/06/2017/GB

## 7. Operation

There are three action keys below the number keys that operate on the numbers displayed in the input value window:



Press the Enter [  ] key to accept the value showing in the number echo window into the system for immediate use.



Press the Backspace [  ] key to erase the last number entered in the string. Multiple presses will back out multiple digits.







Press the Delete [  ] key to delete the entire value showing in the echo window to start a new, or to abort.



GB

### 7.2.7.2 Number Pad / Step

The “Number Pad Step” key pad functions in two different ways:





- (1) A setpoint can be entered in the same way as the Number Key Pad above: key in the number and press Enter [  ], that number is then immediately accepted into the setpoint value.
- (2) Key in a number and press the Step Up [  ] or the Step Down [  ] key, (without pressing the Enter [  ] key), that number will be used to decrease or increase the existing setpoint value.

Subsequent touches of the Step Up or Step Down key will continue to increase or decrease the setpoint by this step value until a new value is keyed in followed by a key press of the Step Up [  ] or the Step Down [  ] key. If the Enter [  ] key is pressed the newly entered value will register as a new setpoint value on the main screen rather than a step value.

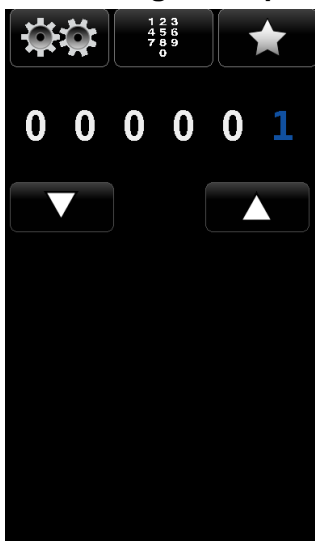
### 7.2.7.3 Digital Step



In the digital Step Data Entry Mode there is initially a string of five white zeros (0) and one blue numeral one (1) across the top as shown in the figure to the left. Any one of these zeros can be converted to a blue 1 by touching it. Slide a finger across the zeros to demonstrate this action. Using this feature each digit of the setpoint can be increased or decreased by one digit at a time by activating the corresponding digit with a blue 1 and pressing the Up [  ] or Down [  ] key.

For example, in the screen below the setpoint is at 50.0000, and the operator would like to change this to 51.0000, 52.0000, 53.0000.... and so on. He simply has to touch the digit in the Digital Step that corresponds to the “ones” digit in the Setpoint, thereby activating that digit and then press the Up [  ] key to increase that digit.





If the resolution of the instrument were set to 4 then the right most digit in the Digital Step screen would correspond to the least significant digit of the setpoint and the left two digits in the Digital Step screen would not be used.

**7.2.7.4 Program Data Entry**

The Program Data entry method provides an automated way to interact with the CPC8000-H. Many setting or process that can be entered manually programmed into the unit and saved and used in the Program portion of the data entry screen. Programs are prepared and stored in the Setup [⚙️] / [Application] / [Program] screen. See Section 7.3.5.3 Programs for details on how to create, edit and save programs.

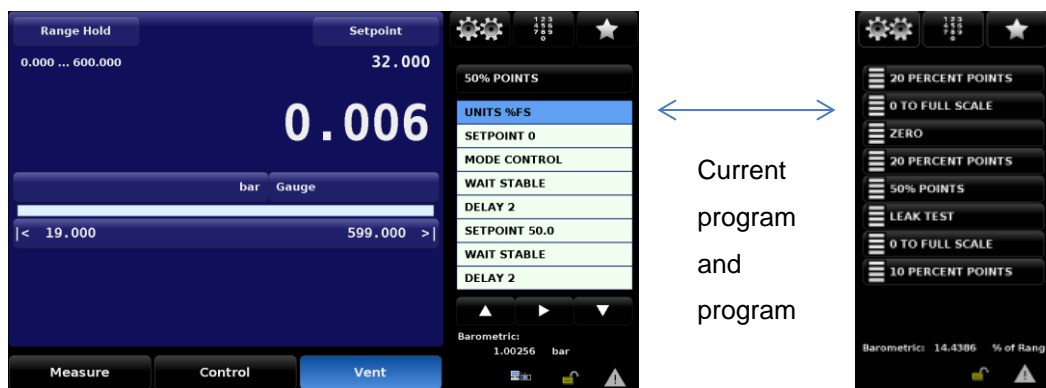

Figure 7-6 Program Data Entry Screen

After a program has been chosen by pressing the program selection button, press the Play [▶️] button to start the program. The Pause [⏸️] button can be pressed at any time to stop the program at the current step, then the Play [▶️] can be pressed to resume. To move forward or backwards in the program press the Back [◀️] button or the Forward [▶️] button. The Stop [■] button will stop the program and place the CPC8000-H in Measure mode.

**7.2.8 Setup**

Press Setup [⚙️] in the sidebar to move out of the main screen and into the setup screens. Notice the bottom row of six subject tabs and the arrow on the left end of the row (see Figure 7-7 Setup Screen Tabs). Each tab will bring up a screen relevant to the subject in the tab title.



Figure 7-7 Setup Screen Tabs

After regaining the main screen, the last visited setup screen will return if Setup [⚙️] is pressed again. Operational information for the setup screens and their associated sidebars is contained in Section 7.3 Setup.

14235993.00/06/06/2017/GB

## 7.2.9 Favorites

The Favorites [★] button provides a place to store programs that are frequently used and also contains several prepackaged programs that are used to perform a leak test and a single point zero of each sensor. Programs that are displayed in the Favorites menu are chosen in the Setup [⚙️] / Applications /Favorites screen. See Section 7.3.5.4 to select displayed favorites.



Figure 7-8 Favorites

## 7.2.10 Status Bar

Located below the number pad is a status bar consisting of two icons.

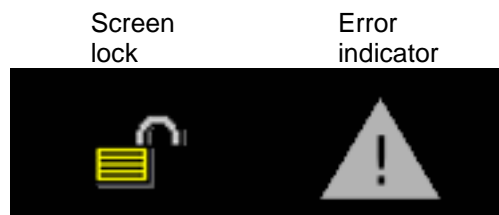

Figure 7-9 Status Bar



Screen lock: This icon indicated the status of the touchscreen: locked or unlocked for manual interaction.



Error indicator: A yellow error indicator triangle indicates that there is an error recorded in the error register. Pressing the yellow error indicator will open the Setup [⚙️] / [Applications] / [Troubleshoot] screen where errors can be viewed. The error register will clear itself when it is viewed, however, this does not correct the error. A corrective action still must be specifically addressed.

## 7.2.11 Secondary and Tertiary Displays

There are two data lines available in the lower portion of the main screen reserved for the operator to display two items from a list of choices. The first line is called the secondary display, and the next line is the tertiary display. The list of choices are identical for both lines. The choices are available for selection in the Setup [⚙️] / [General] [Secondary / Tertiary Display] screen shown in “Figure 7-10 Secondary and Tertiary Displays” below. An explanation on how to setup and choose options for this area is given in Section 7.3.1.2, Secondary and Tertiary Display.



Figure 7-10 Secondary and Tertiary Displays

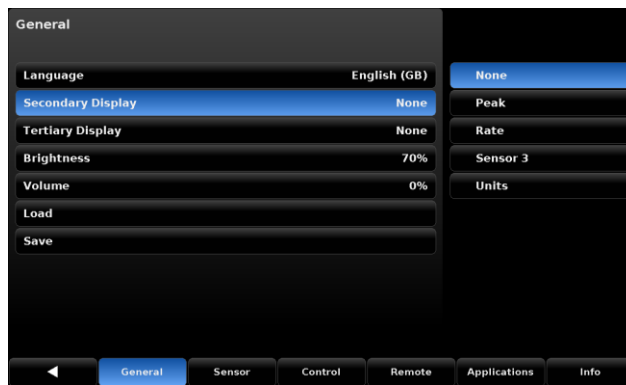

Figure 7-11 Screen of Display Choices

**7.2.12 Limits**

Limits are shown in three places in the main screen. The “Range Limits”, “Control Limits” and “Entry Limits” shown in “Figure 7-12 Limits” below can show two different readings depending on settings. The Range Limits shows the limits of the range selected in Range Hold mode or the limits of the active transducer in Autorange mode. The “Control Limits” are the limits entered into the Setup [ ] / [Control] [Maximum Limits]/[Minimum Limits] screen (see Section 7.3.3.1). The “Control Limits” limit the value that can be entered as a setpoint. The “Entry limits” are equal to the lessor of the Control Limits or the Range Limits (when in Range Hold mode).



Figure 7-12 Limits

**7.2.13 Bar Graph**

The bar graph is always active and reports in real time the pressure at the Measure/Control port. This provides a visual comparison between the actual pressure and the user selected control limits.

14235993.00/06/2017/GB



Figure 7-13 Bar Graph

### 7.2.14 Pressure Units

The pressure units that the CPC8000 is currently using are displayed very near the center of the main screen, just above the bar graph. To change pressure units, touch the current unit symbol to display a page of the units menu in the sidebar. There are forty pre-defined pressure units listed in seven menu pages so it may be necessary to scroll through several pages to locate the desired units. On the screen, touch either the up [▲] or down [▼] symbol to scroll to the next units page. Continue to scroll until the desired pressure units are found; then touch that line in the menu to activate the new units.



Figure 7-14 Pressure Units

There are several tables of conversion factors for pressure units in Section 13.1, Conversion factors, pascal. The PSI table includes the factors for conversion to or from PSI to all of the other available units. Another table uses Bar as the basis for conversion factors to or from most of the more common alternative units.

### 7.2.15 Pressure Type

Pressure type (see Figure 7-2 Main screen items) is a label of either [Gauge] or [Absolute] according to what type of sensor is in the CPC8000-H. The exception is that this feature is an active switch which toggles between [Gauge] and [Absolute] if there is a barometer option included in the system. The barometer is used to emulate gauge pressure when the native transducers are absolute and absolute when the native sensors are gauge. (See Section 4.4.5 Barometric Reference Transducer for details of the barometric reference transducer).

### 7.2.16 Operating Modes

The CPC8000-H has three operating modes: Measure, Control, and Vent. After the system has been switched on, and after a subsequent short self-test, the instrument will automatically be placed in Measure mode. The operator can switch from one mode to another by using the mode selection keys located just below the front panel display.

## 7. Operation



### INFORMATION

When switching from Control mode to Measure mode, the system will not be vented and the last applied pressure will be locked in the system by means of a solenoid valve.

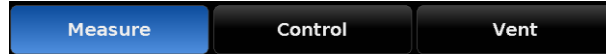





Figure 7-15 Operating Modes

GB

Measure Mode:	Control Mode:	Vent Mode:
 <p>In Measure mode the CPC8000-H acts like a precision pressure measuring instrument and measures the pressure applied at the Measure/Control DUT port. If the Control mode was the last used mode before switching into Measure mode, the last controlled pressure is held in the test assembly.</p> <p>See Section 7.2.16.1, Measure Mode</p>	 <p>In Control mode the CPC8000-H provides a controlled pressure at the Measure/Control DUTport equal to the setpoint value.</p> <p>See Section 7.2.16.2, Control Mode</p>	 <p>The Vent function will vent the system to the atmosphere, including the test assembly connected to the Measure/Control port.</p> <p>See Section 7.2.16.3, Vent Mode</p>

7.2.16.1 Measure Mode

In Measure mode, the instrument measures the pressure at the sensor connected to the Measure/Control DUT port. The Measure mode is activated by pressing the [Measure] button.

GB



Figure 7-16 Measure Mode

If the pressure is beyond the permissible measurement range, the pressure reading is displayed in red instead of white figures. As soon as a pressure of approximately 110% full scale is reached, an integrated safety relief valve opens and releases the pressure into the inside of the instrument. The regulator is not active in Measure mode. The setpoint value can be input while in the Measure mode then Control mode can be activated by pressing the [Control] key and the CPC8000-H will start to control to the setpoint value.

The figure below shows the state of the isolation valves in Measure mode.

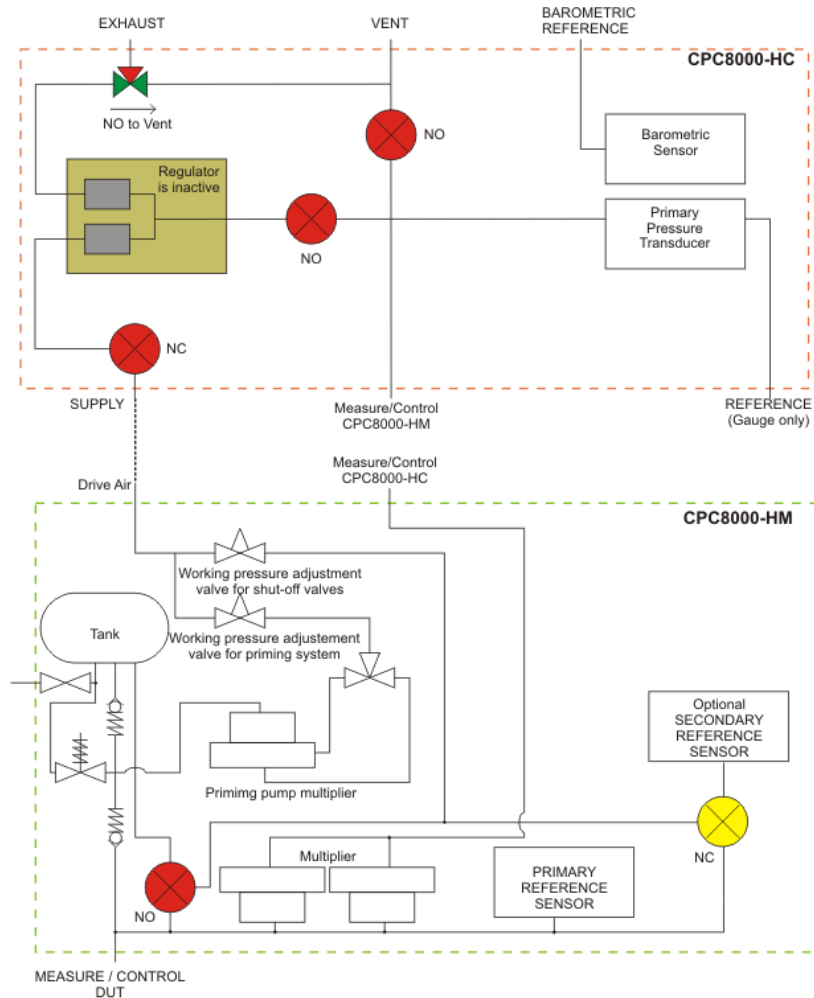

Legende:

- Valve is OPEN
- Valve is CLOSED
- Conditional State\*

NO = Normally Open  
NC = Normally Closed

Figure 7-17 Isolation Valves in Measure Mode

## 7. Operation

### 7.2.16.2 Control Mode

In Control mode, the instrument provides a precise pressure output at the Measure/Control DUT port. The indication of the current pressure value will turn green when the setpoint has been reached and the stable window settings have been satisfied.



Figure 7-18 Control Mode

The Control mode is activated by pressing the [Control] button in the main menu. The Control mode can be accessed from the Measure mode or the Vent Mode by pressing the [Control] button. In the Control mode the CPC8000-H acts as a precision pressure controller and provides a stable pressure output at the Measure/Control DUT port. In order to ensure that the controller is correctly configured for the task it is to perform, the following measures must be taken and the respective parameters must be set in the Setup [⚙️] menu.

- Control limits can be set in the Setup [⚙️] / [Control] / [...limits] screen.

The figure below shows the state of the isolation valves in Control mode. Notice that the regulator is active in the Control mode.

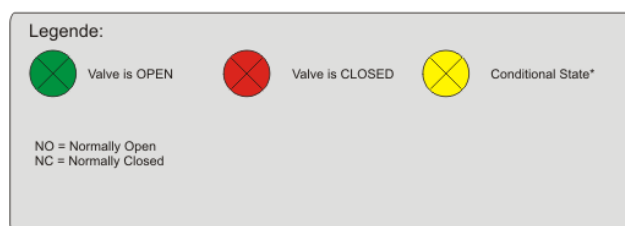
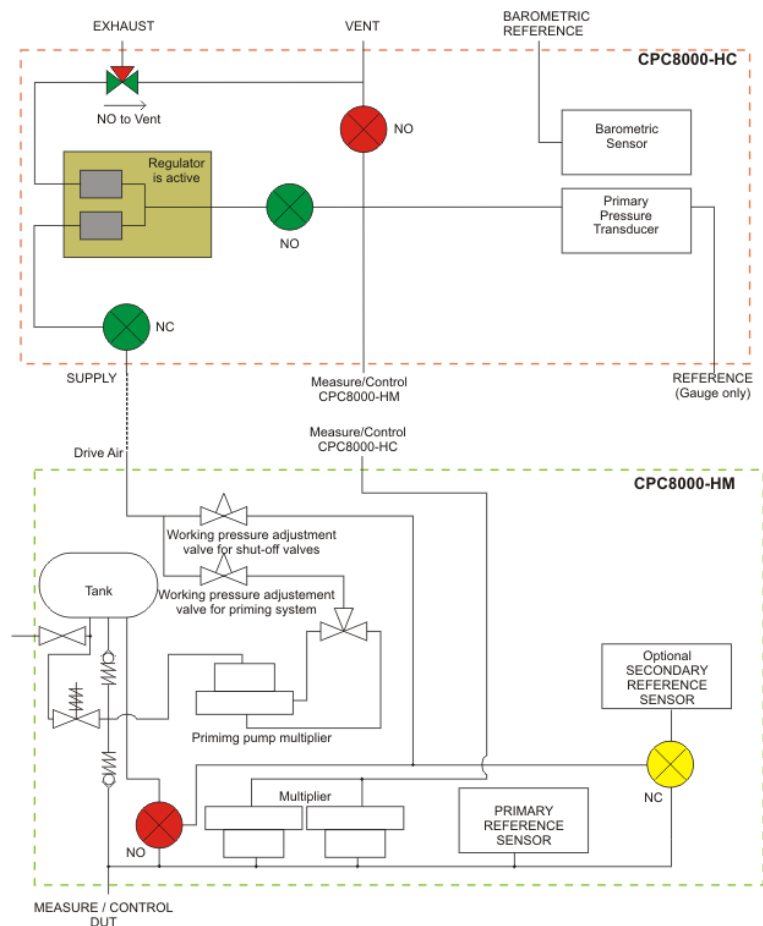

Figure 7-19 Isolation Valves in Control Mode

## 7. Operation

### 7.2.16.3 Vent Mode

Vent mode vents the pneumatic system and shuts off the supply. The Vent mode can be activated from the Measure or Control mode by pressing the [Vent] button. Internal system pressure will be vented through the Vent port.

GB



Figure 7-20 Vent Mode



#### WARNING

Venting will cause a sudden loss of pressure in the system and the plumbing connected to the measure control port. Care must be taken that the device under test is not damaged during venting.



#### WARNING

In some cases venting will exhaust high velocity air from the vent port. Personnel and sensitive equipment should not be in close proximity to the vent port during venting.



#### WARNING

In some cases venting high pressure will cause a loud sound. Personnel should wear a hearing protection device when working with high pressures.

The figure below shows the state of the isolation valves in Vent mode.

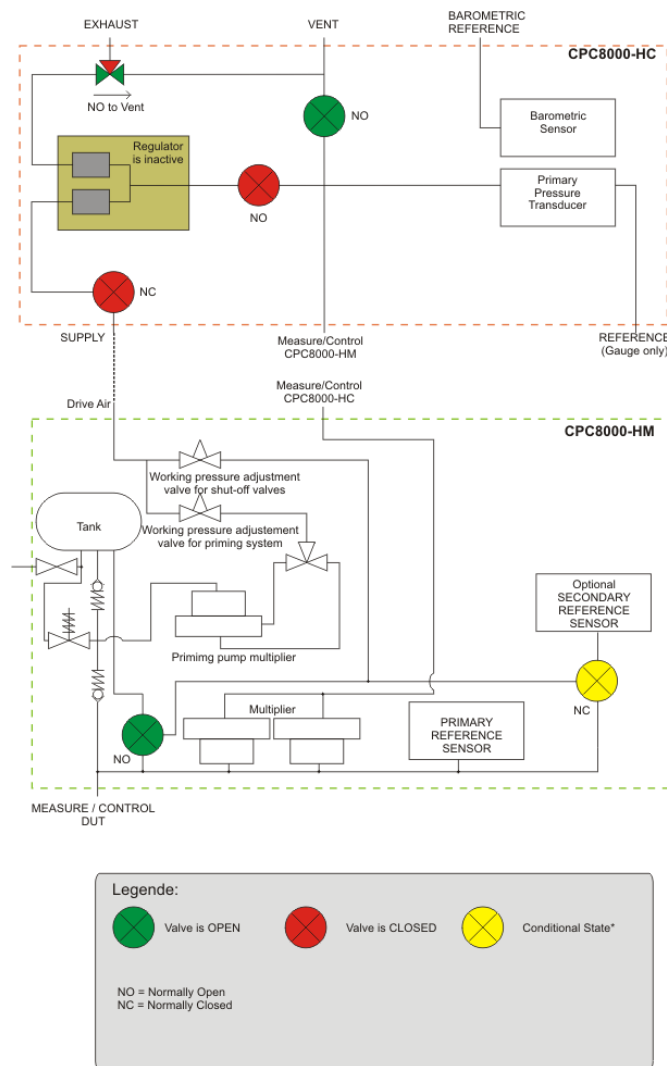

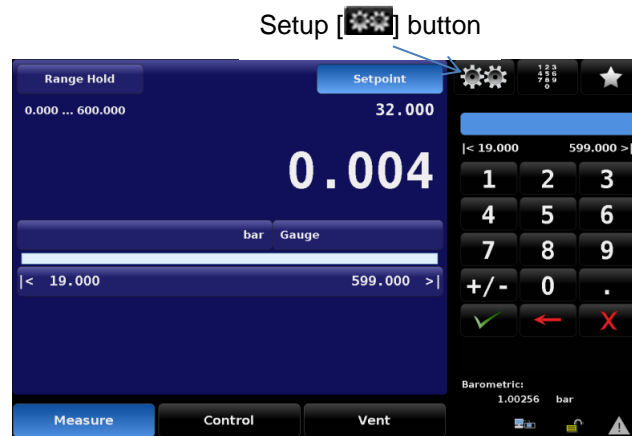

Figure 7-21 Isolation Valves in Vent Mode



## 7.3 Setup

After the instrument has been powered on and the main screen is displayed, press the Setup [  ] button on the sidebar to setup parameters or make changes to the instrument settings.



Setup [  ] button

Figure 7-22 Location of the Setup button

The following picture is a menu tree that shows the general layout of the setup menus. The bullet points in blue represent screens that require the first level password to view; those in red require a second level password to view.



Figure 7-23 Setup Screen Tabs

### 7.3.1 General Tab

#### 7.3.1.1 Language

The languages that are available in the CPC8000 are shown by pressing Setup [  ], then press the [General] tab, and then the [Language] button. Note that the active language is indicated on the right side of the [Language] button. When the [Language] button is pressed, the sidebar will show the languages that are available. Pressing the desired language on the sidebar will make that language active on every screen in the CPC8000.

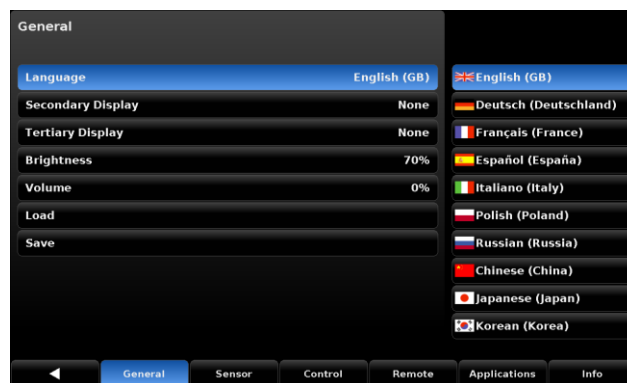

Figure 7-24 Language

#### 7.3.1.2 Secondary and Tertiary Display

The Secondary and Tertiary display areas provide a place to indicate extra data that may be desired during testing or calibration. In the [General] tab, there is a selection button labeled [Secondary Display] and one labeled [Tertiary Display]. Clicking either of these will change to a sidebar to indicate the choices that are available to each of these display areas. Pressing any one of these choices will make that choice active in its respective display area on the main menu.

14235993.00/06/2017/GB

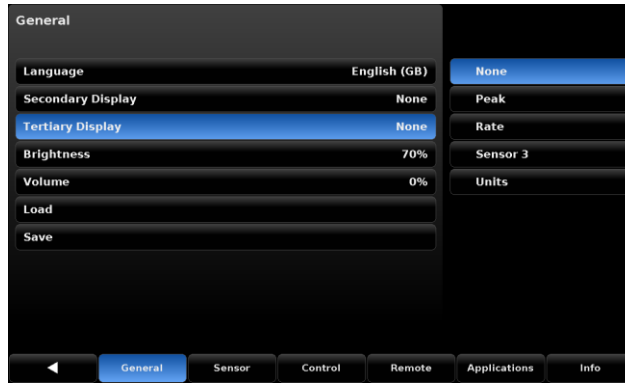

Figure 7-25 Secondary and Tertiary Display

### 7.3.1.3 Brightness

The [Brightness] button within the [General] tab of the Setup [⚙️] menu provides a place to set the global brightness of the instrument’s screens. When the [Brightness] button is chosen a graduated brightness “bar graph” will appear in the sidebar. This is a sliding scale of brightness and can be changed by sliding ones finger up and down on the bar graph or simply touching an area on the graph that corresponds to a brightness level.

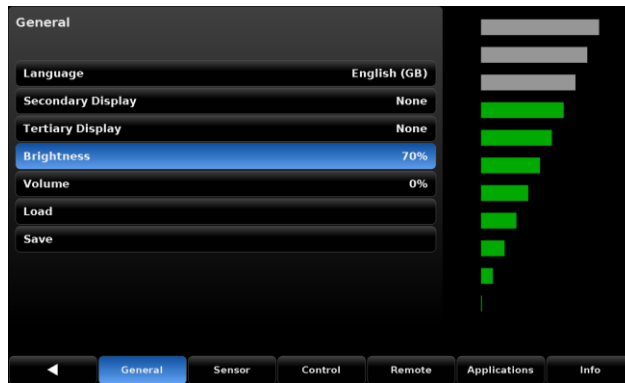

Figure 7-26 Brightness

### 7.3.1.4 Volume

The [Volume] button within the [General] tab of the Setup [⚙️] menu provides a place to set the global volume for the instrument’s auditory feedback sounds. When the [Volume] button is chosen a graduated volume “bar graph” will appear in the sidebar. This shows the relative volumes available and can be changed by sliding ones finger up and down on the bar graph or simply touching an area on the graph that corresponds to the desired volume level.

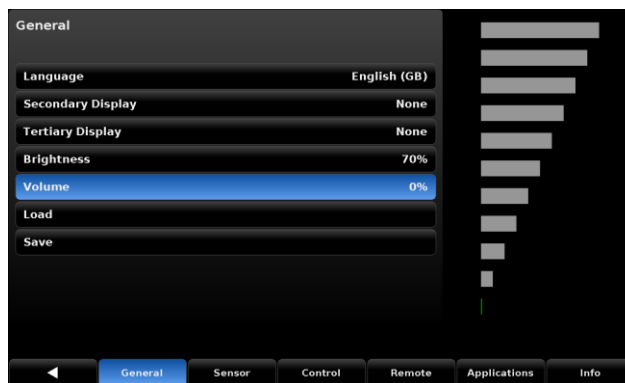

Figure 7-27 Volume

### 7.3.1.5 Load (Configuration)

Each configuration can store a complete set of parameters and settings. Configurations can be recalled (loaded) as needed. Configurations contain settings for the following set of parameters:

Table 3 Stored parameters

Lower limit	Rate stable delay
Upper limit	Vent rate
Setpoint	Emulation mode (gauge/abs)
Step	Filter
Rate setpoint	Resolution
Rate step	Units
Stable window	Rate units
Stable delay	Secondary units
Rate stable window	Brightness
Volume	

Explanation on how to set up each configuration can be found below in Section 7.3.1.5. When the [Load] button is chosen a choice of several configurations are displayed on the sidebar. When one configuration is chosen its loads parameters and settings will be active in the instrument.

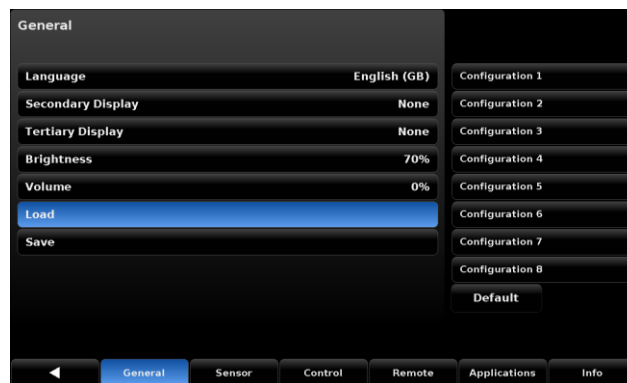

Figure 7-28 Load (configuration)

### 7.3.1.6 Save (configuration)

The [Save] button within the [General] tab of the Setup [🔧] menu, shown in “Figure 7-29 Save (configuration)”, provides a place to save configurations for the instrument. When the [Save] button is chosen a list of configuration numbers are displayed on the sidebar. When a configuration number is chosen and the check mark [✓] is pressed the current instrument settings will be saved within this configuration number. Instrument settings that are saved in configuration settings are given in section 7.3.1.5 Load (Configuration).

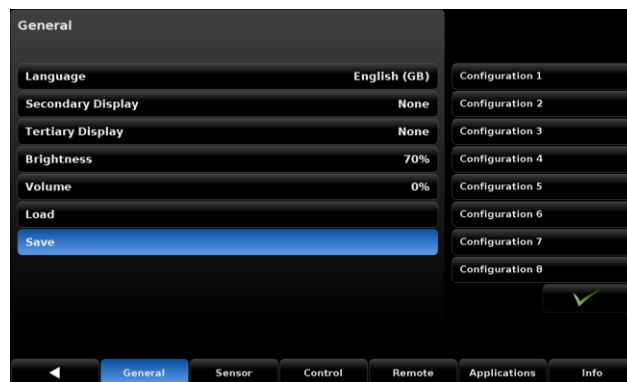

Figure 7-29 Save (configuration)

## 7. Operation

Configurations can be used to save time in setting up parameters for specific calibration needs. For example, there may be a requirement to calibrate a 0 ... 100 psi transducer, and an upper limit of 105 psi cannot be exceeded and the rate of pressure change cannot exceed 5 psi per second. These parameters can be set and assigned (saved) in one of the configuration numbers and recalled (loaded) before this test is run.

GB

### 7.3.2 Sensor Tab

Within the [Sensor] tab of the Setup [⚙️] menu are parameters that are associated with all of the installed pressure transducers. Settings chosen here will affect the indicated and remote output of the instrument's pressure reading.

#### 7.3.2.1 Sensor Filter

In the [Sensor] tab in the Setup [⚙️] menu there is a button labeled [Filter]. The right side of the [Filter] button shows the current filter setting. The sensor filter acts on the output pressure indicated on the instrument, filtering out small pneumatic and electrical variations in the pressure transducer output. This is done by mathematically smoothing the output reading using a low pass filter on the electrical output of the pressure transducer. The filter can be set to Off, Low, Normal or High simply by pressing the associated button on the right side of the menu.

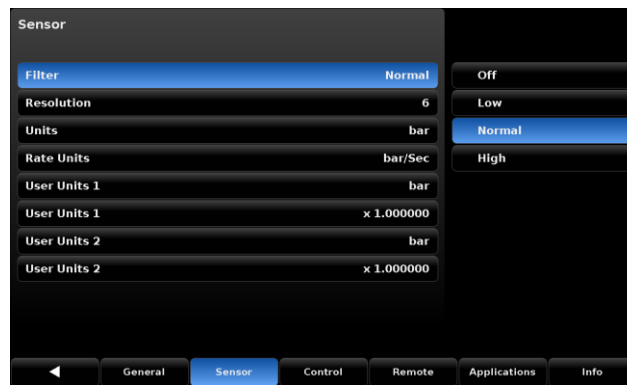

Figure 7-30 Filter

#### 7.3.2.2 Resolution (display digits)

In the [Sensor] tab in the Setup [⚙️] menu there is a button labeled [Resolution]. The right side of the [resolution] button shows the current resolution setting with a blue button. The display resolution for the pressure output can be chosen from this side bar selection menu. The resolution is the number of digits that will be shown in the pressure indication within all screens of the instrument. The user can change the resolution to 4, 5 or 6.

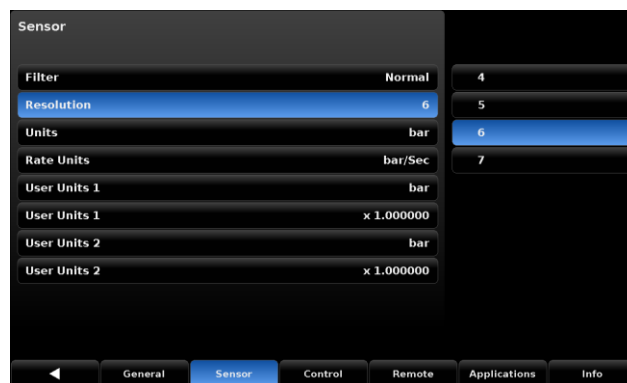

Figure 7-31 Resolution

### 7.3.2.3 Units

In the Setup [⚙️] / [Sensor] tab there is a button labeled [Units]. When selected, the side bar will display a set of 6 selectable units and an Up [▲] and a Down [▼] arrow used to scroll through a set of 38 different units and 2 user defined units. Selecting any of these units will change the unit of measure for the pressure sensed by all of the internal pressure transducers and will also apply these units to reading taken remotely. This same selection of units can be accessed directly from the Main screen by pressing the button displaying the current units.



Figure 7-32 Units

### 7.3.2.4 Rate Units

In the Setup [⚙️] / [Sensor] tab there is a button labeled [Rate Units]. When selected, the side bar will show a choice of time denominator units: Seconds [Sec] and Minutes [Min]. The currently selected time denominator unit (Sec or Min) will have a blue background. Selecting minute [Min] or second [Sec] will apply this time denominator to all rate functions in the instrument including [Rate Setpoint], and [Vent Rate]. When this unit is change, all rate setpoints are adjusted so they are mathematically equivalent to their current setting. For example, If the [Rate Setpoint] is set at 60 psi/min, then changing the rate denominator unit to Seconds would convert the [Rate Setpoint] to 1 psi/sec.



Figure 7-33 Rate Units

### 7.3.2.5 User Units

In the Setup [⚙️] / [Sensor] tab there are several buttons with prefixes “User Units”. These are used to setup the “base unit” and multiplier used to define [User Unit 1] and [User Unit 2]. For [User Unit 1] and [User Unit 2] the process is the same. Selecting the first [User Unit #] will display a choice of [psi], [bar] or [pascal] in the sidebar. Choosing one of these “base units” will form the basis of the equation that defines the [User Unit #] chosen. Immediately below the first [User Unit #] button is the [User Unit #] Multiplier button that indicates the current multiplier and when pressed will display a keypad in the side bar where a new multiplier can be entered. These two choices are used to calculate the value of the [User Unit #] by the following equation:  $\text{User Unit} = 1 \text{ Base Unit} \times \text{Multiplier}$ . For example if a unit is needed, that is not currently available from the 40 choices, for instance tons per square meter (tsm), then the psi conversion factor for this can be found and is: 1 psi = 0.703069 tsm. In this instance psi would be entered as the base unit and 0.703069 as the multiplier. The new user unit associated with this base unit and multiplier would now be displayed when that User Unit is chosen in the main menu or on the Setup [⚙️] / [Sensor] / [Units] screen

14235993.00/06/2017/GB

## 7. Operation

GB

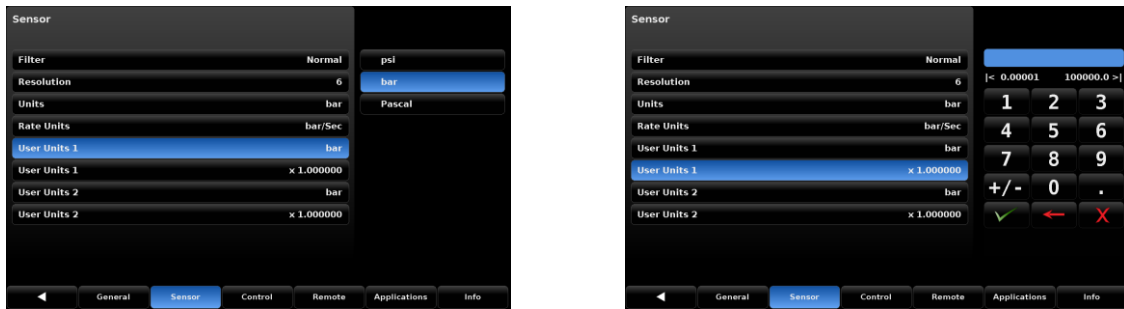

Figure 7-34 User units and user units multiplier

### 7.3.3 Control Tab

The [Control] tab within the Setup [⚙️] menu contains settings that limit or control display elements associated with the pressure output from the instrument's regulator. Control limits, stable window configuration, and the rate setpoint can be found in this section.

#### 7.3.3.1 Max and Minimum Limits

The [Maximum Limit] and [Minimum Limit] buttons under the Setup [⚙️] / [Control] screen provide a place to limit the setpoint that can be chosen in the main screen. These limits can only be set within the range of the active sensor. When the CPC8000 is in Autorange the limits can only be set within the range of the primary transducer which, by convention, will have the widest range. The minimum limit must be lower than the maximum limit. The operator cannot enter setpoints and thereby not control to pressures outside of these limits.

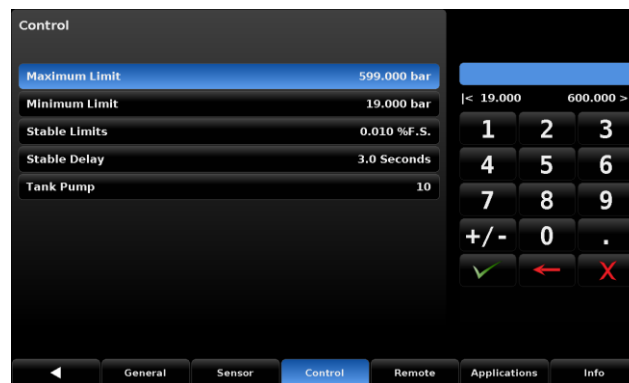

Figure 7-35 Maximum Limit and Minimum Limit Buttons

#### 7.3.3.2 Stable Limits

Both the [Stable Limits] and the [Stable Delay] buttons can be found under the [Control] tab in the Setup [⚙️] menu. Both of these are used to define a stable condition for pressure control or measurement (see Figure 7-36). When the controller enters a stable condition the font color for the pressure indication will change from white to green. For example, an operator would like the CPC8000-H to show a stable indication only after the pressure output has been at the setpoint  $\pm 0.003\%$  FS for 2 seconds. In this case, the [Stable Limit] should be set at 0.002, and the [Stable Delay] should be set at 2. The graphic in Figure 7-37 illustrates this.

14235993.00/06/2017/GB

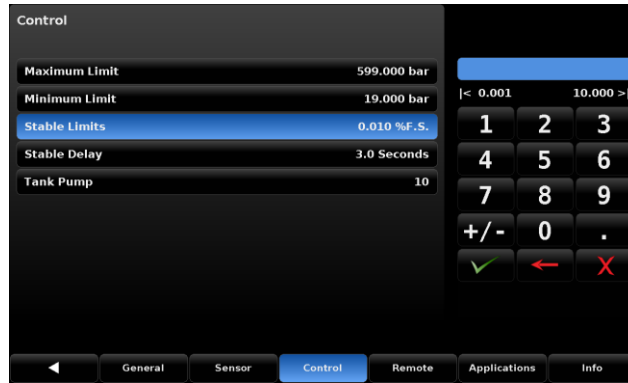

Figure 7-36 Stable Limits and Stable Delay

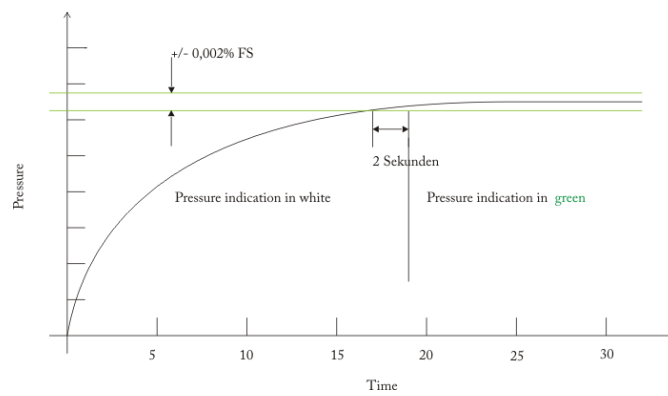

Figure 7-37 Graph Illustration

### 7.3.3.3 Tank Pump

The parameter [Tank Pump], sets the number of flooding cycle the unit will try to fill the volume between the tank and the DUT. The flooding happens when the instrument switches from vent to control mode. During the flooding process the instrument will take the fluid from the tank and will push it in the system.

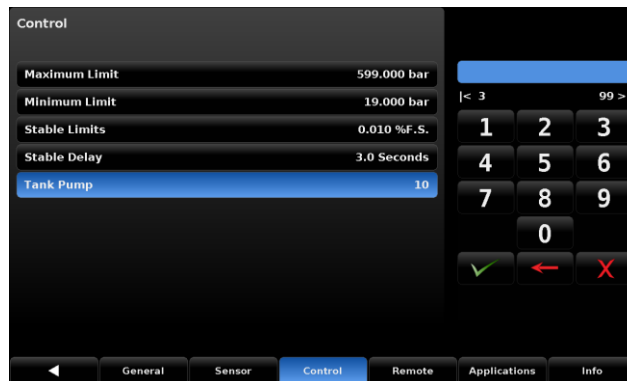

Figure 7-38 Rate Setpoint

### 7.3.4 Remote Tab

The Setup [⚙️] / [Remote] tab is used to choose the command set that will be used for remote communication from an external computer, select the IEEE-488 address, configure Ethernet communication settings and configure serial communications settings. The [Remote] screen has two pages that can be accessed by pressing the page selection [▼ 1:2 ▲] button. Details about the remote operation and command sets are given in Section 8, Remote Operation. Information about the electrical communication connection hardware is given in Section 0,



## 7. Operation

Electrical connection.

### 7.3.4.1 Remote Command Set Setup

The [Command Set] button within the Setup [⚙️] / [Remote] tab provides a place for the operator to choose which command set that will be used within remote communication software used to remotely control the function of the CPC8000-H. When the [Command Set] button is chosen any of the listed command sets seen in the side bar can be selected. This will immediately change the active command set enabling the instrument to respond to commands in that set. See Section 8, Remote Operation, for a list of commands included in each command set.

GB

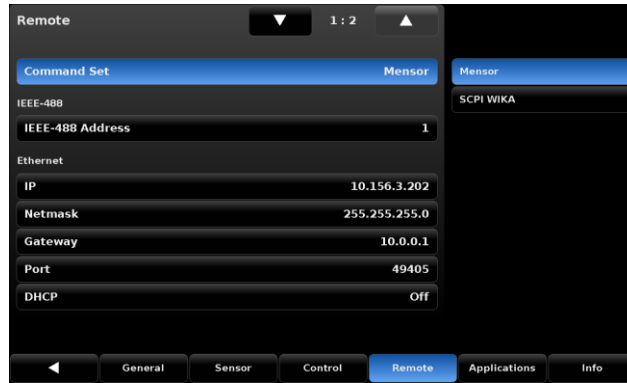

Figure 7-39 Remote Command Set Setup

### 7.3.4.2 IEEE-488 Address

The [IEEE-488 Address] button within the Setup [⚙️] / [Remote] tab provides a place for the operator to set the IEEE-488 Address. When the [IEEE-488 Address] button is pressed the side bar displays the numeric key pad where an address from 1 to 31 can be entered.

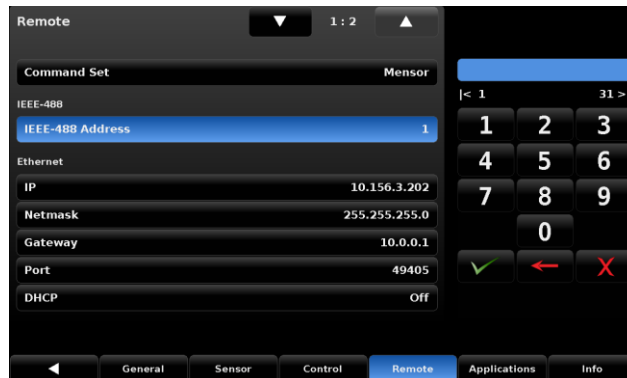

Figure 7-40 IEEE-488 Address

### 7.3.4.3 Ethernet Settings

In the Ethernet section of the Setup [⚙️] / [Remote] tab there are buttons that correspond to Ethernet parameters. When the button is pressed the numeric key pad or a choice selector will be presented on the sidebar and an appropriate number or selection can be entered for the respective parameter. These parameters should be set up to match your host computer.

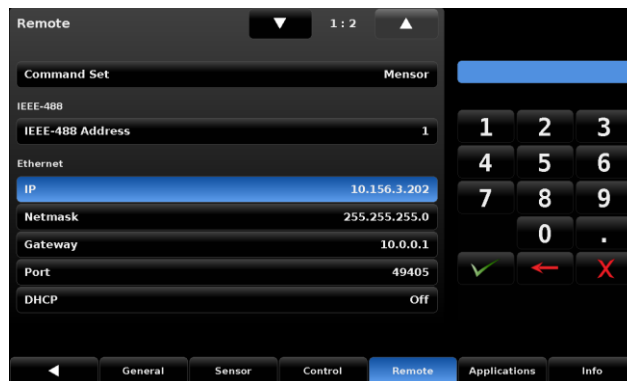

Figure 7-41 Ethernet Settings

### 7.3.4.4 Serial Settings

The "Serial" section in the Setup [⚙️] / [Remote] tab can be viewed by selecting the page down button [▼] on the first page of the [Remote] tab. The Serial setup page has buttons that correspond to serial communication parameters. When a parameter button is pressed a choice selector will be presented on the sidebar and an appropriate selection can be entered for the respective parameter. These parameters should be set up to match your host computer.

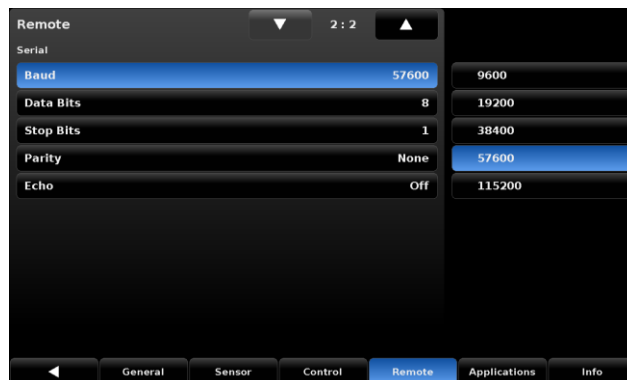

Figure 7-42 Serial Settings

### 7.3.4.5 USB Device Setting

The USB Device jack is a standard USB Type B receptacle interface used for remote communication. The USB Driver can be downloaded at:

[http://www.mensor.com/download\\_software\\_instrument\\_en\\_um.wika](http://www.mensor.com/download_software_instrument_en_um.wika)

### 7.3.5 Applications Tab

Press the [Applications] tab in the Setup [🔧] screen and a screen will appear containing various labeled icons that when pressed access other screens that provide the following functions:

- Calibration of internal transducers
- Sequence program configuration
- Selection of favorites viewable in the main operation screen
- A troubleshooting screen that displays errors
- The advanced screen that is used for tuning the regulator and viewing sensor linearization
- An administration screen used to manage passwords

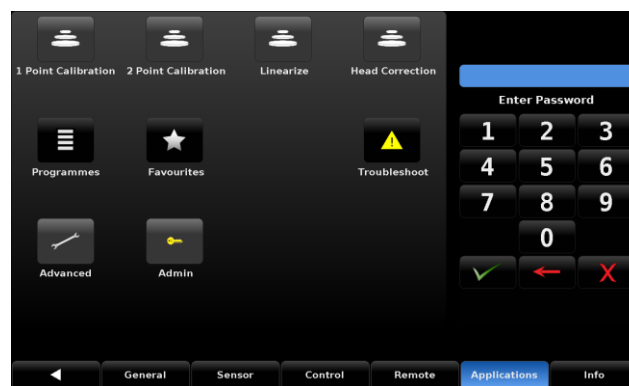

Figure 7-43 Applications Tab - Locked

#### 7.3.5.1 Passwords

All the calibration screens are password protected with the “Calibrate Password”

- [1 Point Calibration]
- [2 Point Calibration]
- [Linearize]
- [Head Correction]

The “Service Password” allows access to:

- [Advanced]
- [Admin]

“Figure 7-44 Applications tab - Unlocked” shows the [Applications] screen when it is unlocked.



#### INFORMATION

The Default Passwords sent with the instrument are as follows:

Calibrate Password: 123456

Service Password: 987654

Both passwords can be changed and saved in the [Admin] page within the [Setup] [🔧] / [Applications] section.

If the passwords are changed then forgotten contact Mensor or your local Mensor service center for instructions to access the protected areas and to reset the passwords.

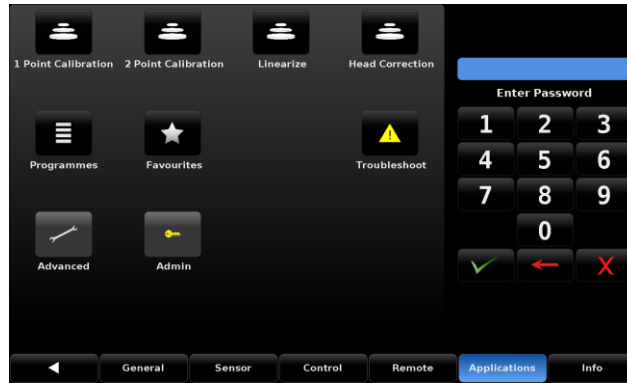

Figure 7-44 Applications tab - Unlocked

7.3.5.2 Head Correction

The Setup [Settings] / [Applications] / [Head Correction] screen is the place to enter parameters that affect the offset that occurs when the device is being calibrated and located at a different level (elevation) compared to the sensor inside of the CPC8000-H. Touching any of the active buttons in this screen will activate the number key pad. Each of the four rows in “Figure 7-45 Head Correction Screen” represent a different parameter in the head correction calculation. In the [Height (INST-DUT)] row, the level of the Device Under Test (DUT) should be subtracted from the instrument reference point (INST) and entered. The gas density used within the calibration system, the gas temperature, and the local gravity should be entered in the subsequent fields. The default height is zero (0) indicating that there is no head correction applied. [English] or [Metric] units can be chosen by pressing the related button.



Figure 7-45 Head Correction Screen english units



Abbildung 7-1 Head Correction Screen metric units

7.3.5.3 Programs

The Setup [Settings] / [Applications] / [Programs] screen is used to create, view and edit programs that are used to automatically run a sequence of commands within the CPC8000-H. There are two tabs at the bottom of the Program screen shown in “Figure 7-46 Programs - Display”. The Display tab provides a place to view each program or add a new one. Pressing the program label (program selection button) at the top left will allow selection of predefined programs from the side bar plus a set of blank labels where new programs can be entered.

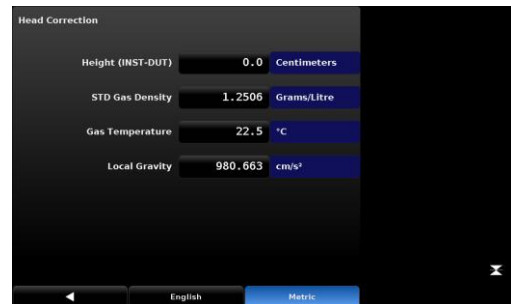
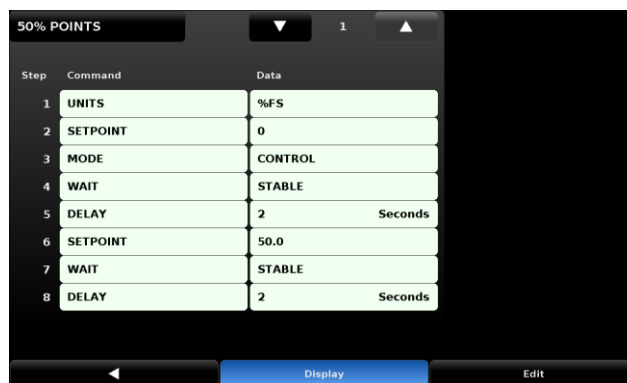

Figure 7-46 Programs - Display

## 7. Operation

With the [Edit] tab selected (Figure 7-47 Programs- Edit) the operator can edit existing programs or create steps in new ones. Pressing a Command or Data point will present the available commands, or a data entry selections in the side bar. The [Insert] and [Delete] buttons allow insertion and deletion of lines. Selection of commands and data in each sequential line will create a draft of resulting command sequence in the selected program, upon exiting the edit mode with the back button [◀] the instrument will ask “Replace old values?”. Pressing the [✓] will accept the changes, pressing the [✗] will revert back to the old program. A list of available commands, data values and their functions are listed in Table 4 on the following page.

GB

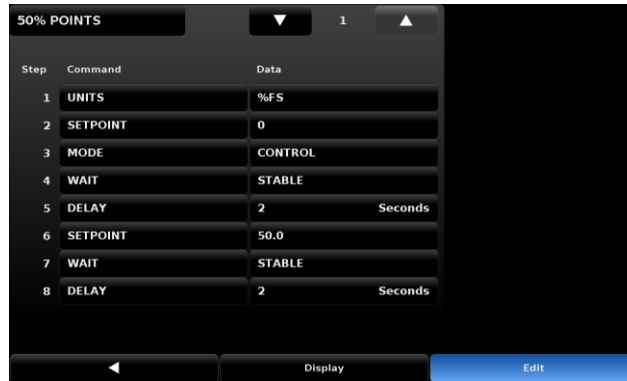

Figure 7-47 Programs- Edit

Table 4 Sequence Commands

Feature	
DELAY	Delays for time = 1 to 3600 seconds (Numerical Entry)
MODE	Sets the control mode (Measure, Control or Vent)
PTYPE	Sets the pressure type (Gauge or Absolute)
RSERPT	Sets the rate setpoint in current units (Numerical Entry)
RUNITS	Sets the rate denominator time unit (min or sec)
SENSOR	Sets the active sensor (1 , 2 or 3)
SEQSTART	Starts the sequence from the beginning (None)
SETPPOINT	Sets the control setpoint for the instrument (Numerical Entry)
SETPPOINT%	Sets the control setpoint in % of current range (Numerical Entry)
WAIT	Waits for a manual input or stable condition (Stable or Input)

### 7.3.5.4 Favorites

The Setup [⚙️] / [Applications] / [Favorites] screen is used to select programs that will appear in the main screen when the Favorites [★] icon is pressed. The current list of favorites is shown in figure 7.5.2.5.6 on the left. Press one of these and then press the available programs on the right to update the current favorites list with that program.

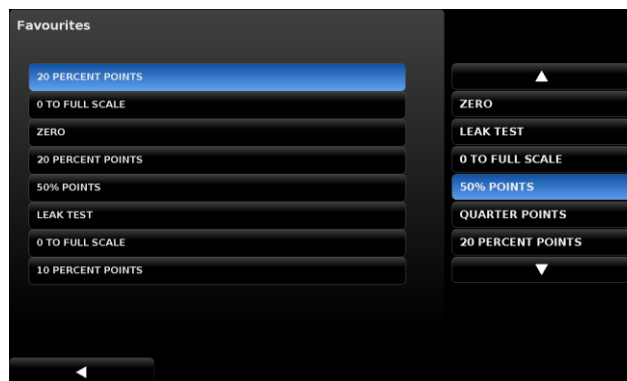

Figure 7-48 Favorites

14235993.00/06/2017/GB

### 7.3.5.5 Troubleshooting

The Setup [🔧] / [Applications] / [Troubleshoot] screen provides a list of internal or remote errors that may have occurred. “Figure 7-49 Troubleshoot” below gives an indication that the CPC8000-H access door has been opened. Once the errors have been viewed in this screen, they are cleared. The [Remote] tab shows errors that have been made through one of the remote communication ports and is helpful in de-bugging remote control software programs.

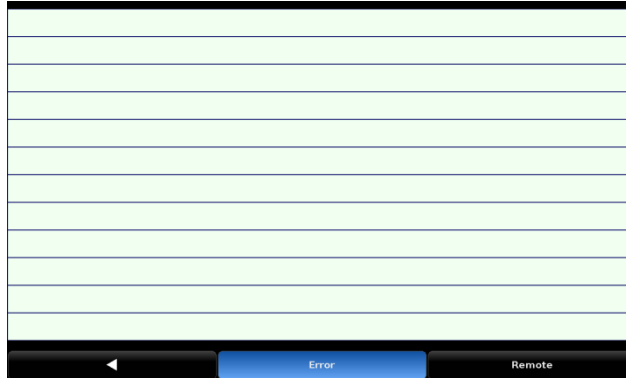

Figure 7-49 Troubleshoot

### 7.3.5.6 Advanced



The Setup [🔧] [Applications] [Advanced] tab and its sub tabs ([Adaptation], [Seal Point] & [Linerization]) should only be used with close supervision from Mensor/WIKA Customer Service. Changing parameters within this section will change the regulator response and may cause the CPC8000-H to fail to meet control specifications or output pressure that could damage externally connected instruments.

### 7.3.5.7 Admin

The Setup [🔧] [Applications] [Admin] Screen has a place to change the Calibration and Service passwords and save configurations.

#### 7.3.5.7.1 Change Password

Press the [Change Password...Calibrate] button to enter a new password, and then accept by pressing the Check [✓] button. The same procedure applies to the [Change Password ...Service] button.

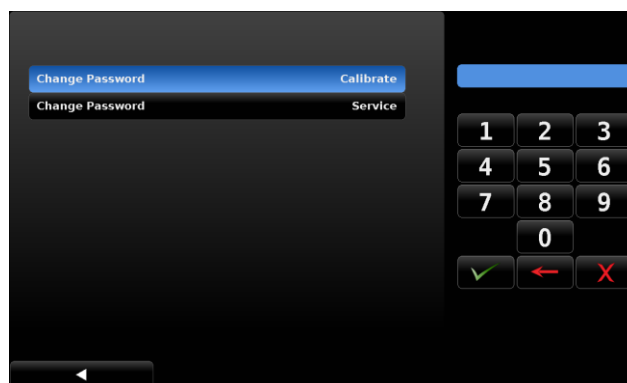

Figure 7-50 Change Password

### 7.3.6 Info Tab

After the instrument has been powered on and the main screen is displayed press the Setup [  ] key and then press the [Info] tab. Information displayed will be the Mensor contact address information, the instrument's serial number, firmware version and a list of the integrated sensors and other information.



Figure 7-51 Information

## 8. Remote Operation

GB

Firmware	Operation instruction
1.8.0	1.1.0

This remote command set is the default set available on the CPC8000-H. All commands must be terminated with a <CR> and/or a <LF>.

A query command ends with a ? for queries. The data column represents the response of the CPC8000-H. All response strings begin either with a space character or an “E” representing that there is an error in the error queue. All response strings are terminated with a <CR> and a <LF>. The error queue holds the last 10 errors identified.

For all commands (no ?), the data column represents the required parameters to be sent to the CPC8000-H following the string in the command column. Any command that requires multiple parameters must have the parameters separated by commas.

One of the first commands issued when starting remote communications should be “Keylock Yes”. This will disable the on-screen keys and tabs, and place the “Keylock” label on the screen. Turning keylock on prevents the potential conflicts that could occur if someone pressed an on-screen key, either intentionally or by accident.

### 8.1 Remote Operation

#### ■ Command and Query Format

Commands must be sent in ASCII format and terminated with either a carriage return <cr>, linefeed <lf>, or both. Commands are not case sensitive. Each query returns a response. If an error is detected the response will include an error flag.

#### ■ Command or Query field

Unless otherwise specified, commands are typically converted to queries by appending a question mark to the command.

#### ■ Data field

The data field is either in ASCII {string} or numeric {value} form. In the case of multiple data fields, commas are required to separate the fields. Queries do not have a data field. String (text) or value (numeric) data are acceptable in any of the following formats:

- Examples of {string} data: ON, OFF, mBar, inHg
- Examples of {value} data: 1, 1.0, -5.678, 25.68324e-5

#### ■ Command Set Definitions

In this manual a data entry made up of alpha characters is defined as a string, as opposed to data containing only numbers, such as “Enter 1 for ON or 0 for OFF” where 1 and 0 are defined as values.

#### ■ Command

Any valid command or query is listed in the following tables Table 6. For commands that take boolean data the following strings are acceptable:

0	1
FALSE	TRUE
NO	YES
OFF	ON

14235993.00/06/2017/GB



## 8. Remote Operation

### ■ Separator

Space (SP).

### ■ Data

ASCII representations of numbers, {value}, or alpha characters, {string}, data as defined above. When sending code a literal variable replaces the brackets and the enclosed character(s) shown in the following examples.

### ■ Termination

Linefeed (LF) or carriage return (CR) is used to signal the end of a command statement. For IEEE-488.2 operation "EOI" is an acceptable alternative. Always send commands in one of the following formats:

1. [Command] [Termination];
2. [Command] [Separator] [Data] [Termination];
3. Queries are special instructions in the form: [Command?] [Termination] where the question mark, "?", immediately precedes the terminator.

When a valid query is received, the CPC8000-H will return {data} terminated by CR and LF. Floating point data is returned in the current engineering units in exponential format.

### ■ Output Formats

Pressure readings are returned in exponential notation in a format according to the OUTFORM command as follows. Outform applies to both pressure channels.

Table 5 Output Formats

Item	Format
1.	<sp> pressure value <cr><lf>
2.	<sp> pressure, units number,STANDBY <cr><lf>
3.	<sp> pressure, pressure rate <cr><lf>
4.	<sp> pressure, minimum peak, maximum peak <cr><lf>

## 8. Remote Operation

### 8.2 Mensor Command Set

The following table lists all of the current CPC8000 commands and queries.

Optional emulation modes are available in which a CPC8000 can emulate remote functions of different brands of pressure gauges. Please contact WIKA/Mensor for more details.

Table 6 Mensor command set

Item	Command or Query	Data	Response/Function
1.	?	none	Returns data per the current output form.
2.	ACQUIRE?	15 char string. Example: Acquire? Test_stand_1 Returns: <sp>(yes or no),CCC... CCC<cr><lf>	This command is used when multiple computers would like to control the instrument. Yes if acquisition is successful. No if instrument is being controlled with another computer. CCC... = name of controlling computer. See: RELEASE? and UNLOCK
3.	ADDRESS	0-31	Sets the GPIB Address
4.	ADDRESS?	<sp> xx <cr><lf>	Returns the GPIB Address
5.	ASSET_TAG	16 char string	General purpose string for customer use.
6.	ASSET_TAG?	<sp>ssssssssssssssss<cr><lf>	Return customer asset tag string.
7.	AUTORANGE	ON or OFF	Sets whether the autorange function is enabled or disabled.
8.	AUTORANGE?	<sp>(ON or OFF)<cr><lf>	Returns whether the autorange function is enabled or disabled.
9.	AUTOZERO	none	Re-zero all the ranges. These adjustments are not password protected and are not saved through power cycles. This command takes approximately 60 seconds but may take longer depending on the time to become stable.
10.	AUTOZERO?	S,T,X,X	Returns autozero data where S represents state (0 = complete, 1 = local autozero, 2 = remote autozero), T represents the estimated time to complete in seconds, and x is a (0) character since this data location is not used at this time.

14235993.00/06/2017/GB

## 8. Remote Operation

Item	Command or Query	Data	Response/Function
11.	AUTOZEROABORT	none	Aborts autozero. Any sensors that have been zeroed will not revert to previous zero offsets.
12.	A?	<sp>n.nnnnne+nn<cr><lf>	Returns the A channel pressure reading
13.	BARO?	<sp>n.nnnnne+nn<cr><lf>	Returns reading from barometric sensor
14.	CALDISABLE	YES or NO	Sets whether or not calibration of the active channel is disabled.
15.	CALDISABLE?	<sp>(yes or no)<cr><lf>	Returns whether or not calibration of the active channel is disabled.
16.	CERR	none	Clears the error queue.
17.	CHANFUNC	Press, peak, rate, rate setpt, dio, units	Sets the secondary display function mode, works identical to Chanfunc2 (kept for backwards compatibility).
18.	CHANFUNC?	<sp>CCCCC...<cr><lf>	Returns the secondary alternate function mode, works identical to Chanfunc2 (kept for backwards compatibility).
19.	CHANFUNC2	Press, peak, rate, rate setpt, dio, units	Sets the secondary display function mode.
20.	CHANFUNC2?	<sp>CCCCC...<cr><lf>	Returns the secondary alternate function mode.
21.	CHANFUNC3	Press, peak, rate, rate setpt, dio, units	Sets the tertiary display function mode.
22.	CHANFUNC3?	<sp>CCCCC...<cr><lf>	Returns the tertiary alternate function mode.
23.	CMDSET	Mensor, SCPI	Activates remote command set for instrument emulation modes.
24.	CMDSET?	<sp><CCCCCC><cr><lf>	Returns active command set identifier.
25.	CONTROL	none	Instrument placed in Control Mode
26.	CONTROL?	<sp>(YES or NO)<cr><lf>	Returns YES if instrument is in control. No if otherwise.
27.	CRATE		Sets the control rate.

GB

14235993.00/06/2017/GB

## 8. Remote Operation

Item	Command or Query	Data	Response/Function
28.	CRATE?	<sp>CCCCCC<cr><lf>	Returns the control rate – CCCC is variable in length and corresponds to the parameters for the CRATE command.
29.	CTYPE?		Returns the type of regulator.
30.	DECPT	4, 5, 6 or 7	Sets the number of decimal points.
31.	DECPT?	<sp>n<cr><lf>	Returns the number of decimal points. (See: Resolution)
32.	DEFAULT	none	Sets the default values.
33.	DHCP	ON or OFF	Reserved for DHCP setup.
34.	DHCP?	<sp>(YES or NO)<cr><lf>	Reserved for DHCP setup.
35.	DIO	2 or 0	2 turns on the first digital output pin, 0 turns it off.
36.	DIO?	<sp>n<cr><lf>	Returns status of the first input and output pin. Bit0 = input's status, bit1 = output's status.
37.	DOUTFUNC	<n><sp><CCCCCC><cr><lf>	Sets the function for output pin <n> to NONE, STABLE, PUMP, MEASURE, CONTROL, or VENT.
38.	DOUTFUNC?	<sp><CCCCCC><cr><lf>	Returns the function for output pin <n>.
39.	DINFUNC	<n><sp><CCCCCC>	Sets the function for input pin <n> to NONE, MEASURE, CONTROL, VENT, KEYLOCK, or START.
40.	DINFUNC?	<sp><CCCCCC><cr><lf>	Returns the function for output pin <n>.
41.	DOUTSTATE	<n><sp>HIGH/LOW/1/0>	Turns output pin <n> to high or low. Sets the function for that pin to "None".
42.	DIOSTATE?	<sp><n><cr><lf>	Bit 0-7 is the status of the input bits. Bit 8-15 are the status of the output bits. Returns an integer between 0 and 65536.
43.	DOC	mm/dd/yyyy	Sets the date of cal for the active channel.

Item	Command or Query	Data	Response/Function
------	------------------	------	-------------------

## 8. Remote Operation

44.	DOC?	<sp>mmddy<cr><lf>	Returns the date of cal for the active channel.
45.	DOM?	<sp>mm/dd/yyyy<cr><lf>	Returns the date of manufacture
46.	ERROR?	<sp>text<cr><lf>	Returns an Error message
47.	ERRORNO?	<sp>Enn-text<cr><lf>	Returns pcs400 error code and text.
48.	FILTER	Off, Low, Normal, High	Sets the reading filter 0, 80%, 92%, 95%.
49.	FILTER?	<sp> (filter)<cr><lf>	Returns the reading filter.
50.	GASDENSITY	Value in lb/cuft	Sets the head pressure gas density.
51.	GASDENSITY?	<sp>n.nnnne+nn<cr><lf>	Gets the head pressure gas density.
52.	GASTEMP	Value in degrees F	Sets the head pressure gas temperature.
53.	GASTEMP?	<sp>n.nnnne+nn<cr><lf>	Gets the head pressure gas temperature
54.	GATEWAY	nnn.nnn.nnn.nnn	Sets the Ethernet gateway address
55.	GATEWAY?	<sp>n.nnnne+nn<cr><lf>	Gets the Ethernet gateway address
56.	HEIGHT	Value in inches	Sets the head pressure height
57.	HEIGHT?	<sp>n.nnnne+nn<cr><lf>	Gets the head pressure height
58.	ID?	<sp> MENSOR, 2500, sssss,v.v.vv	Ssssss is the serial number, v.v.vv is the CPG 2500 software version.
59.	IP	nnn.nnn.nnn.nnn	Sets the IP address of the instrument.
60.	IP?	<sp>nnn.nnn.nnn.nnn<cr><lf>	Returns the IP address of the instrument
61.	KEYLOCK	YES or NO	Locks or unlocks keyboard
62.	KEYLOCK?	<sp>(yes or no)<cr><lf>	Returns yes or no
63.	LIST?	<sp>Pri,1;Sec,1;Bar,1<cr><lf>	Returns list of available sensors and turndowns. Turndowns are obsolete and therefore set to 1 for backwards compatibility.
64.	LISTCAL?	<sp>PRI,{sn},1,{mmddy};SEC,{sn},1,{mmddy};BAR,{sn},mmddy<cr><lf>	

GB

14235993.00/06/2017/GB

## 8. Remote Operation

GB

Item	Command or Query	Data	Response/Function																																																									
65.	LISTRANGE?	PRI,1, min,max	Returns the range of the installed sensor for the active channel																																																									
66.	LOCALE	locale code	Sets Language and Country code. <table border="1"> <thead> <tr> <th>Locale Code</th> <th>Language</th> <th>Country</th> </tr> </thead> <tbody> <tr><td>en_us</td><td>english</td><td>usa</td></tr> <tr><td>en_ca</td><td>english</td><td>canada</td></tr> <tr><td>en_gb</td><td>english</td><td>Great britten</td></tr> <tr><td>fr_fr</td><td>french</td><td>france</td></tr> <tr><td>fr_ca</td><td>french</td><td>canada</td></tr> <tr><td>es_es</td><td>spanish</td><td>spain</td></tr> <tr><td>es_mx</td><td>spanish</td><td>mexico</td></tr> <tr><td>de_de</td><td>german</td><td>germany</td></tr> <tr><td>it_it</td><td>italian</td><td>italy</td></tr> <tr><td>zh_ch</td><td>chinese</td><td>china</td></tr> <tr><td>ko_ko</td><td>korean</td><td>korea</td></tr> <tr><td>ru_ru</td><td>russian</td><td>russia</td></tr> <tr><td>de_ch</td><td>german</td><td>switzerland</td></tr> <tr><td>fr_ch</td><td>french</td><td>switzerland</td></tr> <tr><td>en_ie</td><td>english</td><td>ireland</td></tr> <tr><td>ja_jp</td><td>japanese</td><td>japan</td></tr> <tr><td>pl_pl</td><td>polish</td><td>poland</td></tr> <tr><td>pt_pt</td><td>portuguese</td><td>portugal, brazil</td></tr> </tbody> </table>	Locale Code	Language	Country	en_us	english	usa	en_ca	english	canada	en_gb	english	Great britten	fr_fr	french	france	fr_ca	french	canada	es_es	spanish	spain	es_mx	spanish	mexico	de_de	german	germany	it_it	italian	italy	zh_ch	chinese	china	ko_ko	korean	korea	ru_ru	russian	russia	de_ch	german	switzerland	fr_ch	french	switzerland	en_ie	english	ireland	ja_jp	japanese	japan	pl_pl	polish	poland	pt_pt	portuguese	portugal, brazil
Locale Code	Language	Country																																																										
en_us	english	usa																																																										
en_ca	english	canada																																																										
en_gb	english	Great britten																																																										
fr_fr	french	france																																																										
fr_ca	french	canada																																																										
es_es	spanish	spain																																																										
es_mx	spanish	mexico																																																										
de_de	german	germany																																																										
it_it	italian	italy																																																										
zh_ch	chinese	china																																																										
ko_ko	korean	korea																																																										
ru_ru	russian	russia																																																										
de_ch	german	switzerland																																																										
fr_ch	french	switzerland																																																										
en_ie	english	ireland																																																										
ja_jp	japanese	japan																																																										
pl_pl	polish	poland																																																										
pt_pt	portuguese	portugal, brazil																																																										
67.	LOCALE?	<sp>{string}<cr><lf>	Returns current language and Country locale.																																																									
68.	LOCALGRAVITY	value in ft/s <sup>2</sup>	Sets the local gravity in feet/sec <sup>2</sup> .																																																									
69.	LOCALGRAVITY?	<sp>n.nnnnne+nn<cr><lf>	Returns the local gravity in feet/sec <sup>2</sup>																																																									
70.	LOWERLIMIT	Value inside primary xducer in current units.	Sets the lower control limit for the instrument																																																									
71.	LOWERLIMIT?	<sp>n.nnnnnE+nn<cr><lf>	Returns the lower control limit for the instrument in current units.																																																									
72.	MEASURE	none	Instrument placed in Measure Mode																																																									
73.	MEASURE?	<sp>(YES or No)<cr><lf>	Returns Yes if instrument is in measure. No if otherwise																																																									
74.	MODE	Standby, Measure, Control, Vent	Sets the operation mode																																																									
75.	MODE?	<sp>XXXXXX<cr><lf>	Returns the operation mode																																																									
76.	NETMASK	nnn.nnn.nnn.nnn	Sets the Ethernet network mask.																																																									
77.	NETMASK?	<sp>nnn.nnn.nnn.nnn<cr><lf>	Gets the Ethernet network mask.																																																									
78.	OUTFORM	1 to 7 - Table 5	Sets the output format.																																																									

14235993.00/06/2017/GB

## 8. Remote Operation

Item	Command or Query	Data	Response/Function
79.	OUTFORM?	<sp>X<cr><lf>	Returns the output format (see Table 5).
80.	PEAKMAX?	<sp>n.nnnnne+nn<cr><lf>	Returns the maximum pressure since peakreset was sent.
81.	PEAKMIN?	<sp>n.nnnnne+nn<cr><lf>	Returns the minimum pressure since peakreset was sent.
82.	PEAKRESET	None	Resets the peak values.
83.	PORT	nnnnnn	Sets the Ethernet port of the instrument
84.	PORT?	<sp>nnnnn<cr><lf>	Returns the Ethernet port of the instrument.
85.	PTYPE	Absolute, Gauge or Differential	Sets the instrument pressure type – only works if the optional barometric sensor is installed.
86.	PTYPE?	<sp>CCCC<cr><lf>	Returns “Absolute” or “Gauge” for the pressure type.
87.	RANGEMAX?	<sp>XXXXXXX<cr><lf>	Returns the maximum range of the active transducer in the current units.
88.	RANGEMIN?	<sp>XXXXXXX<cr><lf>	Returns the minimum range of the active transducer in the current units.
89.	RATE?	<sp>XXXXXXX<cr><lf>	Returns the rate reading of the instrument in current units/second.
90.	RDECPT?	<sp>n<cr><lf>	Returns the number of rate decimal points for the active channel. (see RESOLUTION)
91.	RELEASE?	15 char string Example: Release? Test_stand_1 Returns: <sp>(yes or no), CCC...CCC<cr><lf>	This command is used to release control of the instrument in a multiple computer environment. Yes if release is successful. No if instrument is being controlled with another computer. CCC... = name of controlling computer or AVAILABLE.  See: ACQUIRE? and UNLOCK
92.	RESOLUTION	n	Sets the number of significant digits. See DECPT?
93.	RESOLUTION?	<sp>n<cr><lf>	Returns the number of significant digits. See DECPT?
94.	RFILTER	value in %	Sets the % of the rate filter.
95.	RFILTER?	<sp>n.nnnnne+nn<cr><lf>	Returns the rate filter.
96.	RSETPT	Value in current units	Sets the rate setpoint.
97.	RSETPT?	<sp>n.nnnnnE+nn<cr><lf>	Returns the rate setpoint.

GB

14235993.00/06/2017/GB

## 8. Remote Operation

GB

Item	Command or Query	Data	Response/Function
98.	RUNITS	Sec, min, hr	Sets the rate time unit.
99.	RUNITS?	<sp>XXXX<cr><lf>	Returns the rate time unit.
100.	SBAUD	9600, 19200, 38400, 57600	Sets the serial baud rate
101.	SBAUD?	<sp>XXXX<cr><lf>	Returns the serial baud data.
102.	SDATA	7 or 8	Sets the serial data bits
103.	SDATA?	<sp>X<cr><lf>	Returns the serial data bits number
104.	SENSOR	1, 2, 3, or PRIMARY, SECONDARY, TERTIARY	Sets the active sensor.
105.	SENSOR?	<sp>XXXXXXXX,1<cr><lf>	Returns active sensor in long string format.
106.	SENSORID?	<sp>Mensor QRS,SN XXXXXX,VER V.VV	Returns the active sensor's serial number and firmware version
107.	SETPT	value inside upper and lower limits	Sets the control setpoint for the instrument.
108.	SETPT?	<sp>XXXXXXXX<cr><lf>	Returns the control setpoint in current units.
109.	SETPT%	Value in % of current range	Sets the control setpoint in % of current range
110.	SETPTPCT	Value in % of current range	Sets the control setpoint in % of current range
111.	SETPTPCT?	<sp>n.nnnnne+nn<cr><lf>	Returns the current setpoint in % of current range.
112.	SPAN	desired pressure or ?	Sets span on active channel or for ?, clears previous value, must be >50% FS and has a 1% limit.
113.	SPAN?	<sp>XXXXXXXX<cr><lf>	Returns span scale factor for active channel.
114.	SPARITY	even, odd, none	Sets the serial parity
115.	SPARITY?	<sp>CCCC<cr><lf>	Returns the serial parity
116.	SRQMASK	Stable, Error or both	Sets the CPC8000 to issue a service request (SRQ) over the IEEE when the pressure control is stable, or an error occurs. These are 80 hex and 40 hex respectively.
117.	SRQMASK?	<sp>{string}<cr><lf>	Returns "stable", "error" or "error, stable" depending on the SRQ.
118.	SSTOP	1 or 2	Sets the serial stop bits.
119.	SSTOP?	<sp>X<cr><lf>	Returns the serial stop bits
120.	STABLE?	<sp>(YES or NO)<cr><lf>	Returns Yes if instrument is stable, or No.
121.	STABLEDELAY	0 to 65535	Sets the stable time to the number of seconds specified.

14235993.00/06/2017/GB



## 8. Remote Operation

Item	Command or Query	Data	Response/Function
122.	STABLEDELAY?	<sp>XXXXXXX<cr><lf>	Returns the stable time.
123.	STABLETIME	0 to 65535	Sets the stable time to the number of seconds specified.
124.	STABLETIME?	<sp>XXXXXXX<cr><lf>	Returns the stable time.
125.	STABLEWIN	%FS value	Sets the stable window as a %FS
126.	STABLEWIN?	<sp>n.nnnnnE+nn<cr><lf>	Returns the stable window.
127.	STANDBY	none	Instrument placed in Standby mode
128.	STANDBY?	<sp>(YES or NO)<cr><lf>	Returns yes if instrument is in Standby, no if otherwise
129.	STEP	value inside upper and lower limits and inside the range of the active sensor	Sets the control step size for the instrument
130.	STEP-	none	Jogs the setpoint down one step
131.	STEP+	none	Jogs the setpoint up one step
132.	STEP?	<sp>+n.nnnnnE+nn<cr><lf>	Returns the control step for the instrument
133.	STEP%	Value in % of current range	Sets the control step in % of current range.
134.	STEPPCT	Value in % of current range	Sets the control step in % of current range.
135.	STEPPCT?	<sp>n.nnnnnE+nn<cr><lf>	Returns the control step in % of current range.
136.	UNITS	units code or text in Table 7	Sets the engineering units for the active channel
137.	UNITS?	<sp>CCCC<cr><lf>	Returns the pressure units of the active channel in a text string.
138.	UNLOCK	none	Releases Acquire locks. See ACQUIRE? and RELEASE?
139.	UPPERLIMIT	Value inside primary xducer-Range in current units	Sets the upper control limit for the active transducer.
140.	UPPERLIMIT?	<sp>xxxxxxx<cr><lf>	Returns the upper control limit for the active transducer.
141.	VENT	None	Instrument placed in Vent Mode
142.	VENT?	<sp>(YES or NO)<cr><lf>	Returns yes if instrument is in Vent, no if otherwise
143.	WINDOW	value in current units	Sets the exponential filter window for the active channel.
144.	WINDOW?	<sp>n.nnnnne+nn<cr><lf>	Returns the exponential filter window for the active channel.
145.	ZERO	desired pressure or ?	Sets zero to set pressure or for ?, clears previous value.
146.	ZERO?	<sp>xxxxxxx<cr><lf>	Returns zero offset for active channel.

GB

14235993.00/06/2017/GB

## 8. Remote Operation

### 8.2.1 Error Codes

GB

Code	Serial Poll Byte	Description	Error String Returned
E00	00h	No errors	NO ERRORS
E05	45h	Parameter error	EGPIB PARAMETER ERROR: String that was sent
E07	47h	Syntax error	EGPIB SYNTAX ERROR: String that was sent

## 8. Remote Operation

### 8.2.2 Units syntax

Table 7 Units syntax Mensor command set

Item	Description	Output Format	Type
1.	pounds per square inch	PSI	English
2.	inches of mercury @ 0°C	INHG	English
3.	inches of mercury @ 60°F	INHG	English
4.	inches of water @ 4°C	INH2O	English
5.	inches of water @ 20°C	INH2O	English
6.	inches of water @ 60°F	INH2O	English
7.	feet of water @ 4°C	FTH2O	English
8.	feet of water @ 20°C	FTH2O	English
9.	feet of water @ 60°F	FTH2O	English
10.	millitorr	MTORR	Metric
11.	inches of sea water @ 0°C	INSW	English
12.	feet of sea water @ 0°C	FTSW	English
13.	atmospheres	ATM	English
14.	bars	BAR	Metric
15.	millibars	MBAR	Metric
16.	millimeters of water @ 4°C	MMH2O	Metric
17.	centimeters of water @ 4°C	CMH2O	Metric
18.	meters of water @ 4°C	MH2O	Metric
19.	millimeters of mercury @ 0°C	MMHG	Metric
20.	centimeters of mercury @ 0°C	CMHG	Metric
21.	torr	TORR	Metric
22.	kilopascals	KPA	Metric
23.	Pascals	PA	Metric
24.	dynes per square centimeter	DY/CM2	Metric
25.	grams per square centimeter	G/CM2	Metric
26.	kilograms per square centimeter	KG/CM2	Metric
27.	meters of sea water @ 0°C	MSW	Metric
28.	ounce per square inch	OSI	English
29.	pounds per square foot	PSF	English
30.	tons per square foot	TSF	English

GB

14235993.00/06/2017/GB

## 8. Remote Operation

Item	Description	Output Format	Type
32.	micron of mercury @ 0°C	mHG	Metric
33.	tons per square inch	TSI	English
34.	hectapascals	HPA	Metric
36.	megapascals	MPA	Metric
37.	millimeters of water @ 20°C	MMH2O	Metric
38.	centimeters of water @ 20°C	CMH2O	Metric
39.	meters of water @ 20°C	MH2O	Metric

### 8.3 SCPI Specific commands

Table 8 General SCPI commands

Command or Query	Response / Function
*IDN?	Returns identification string
*RST	Reset to known state (default+psi)
*TST?	Returns 1
*OPC	Operation completed
*WAI	Returns operation completed state
*CLS	Clear status and error queue
*ESE	Enable status event
*ESE?	Returns enable status even value
*ESR	Event status register
*ESR?	Returns even status register value
*SRE	Service request enable
*SRE?	Returns service request enable value
*STB?	Returns status byte

## 8. Remote Operation

### 8.4 SCPI Command Set

Table 9 SCPI – WIKA Befehlssatz

Item	Command or Query	Response/Function
<b>STATus</b>		
:OPERation		
1.	:CONDition?	Returns an integer value representing instrument status that can be decoded. Bit 0: Zeroing active. Bit 1: Control Setpoint has not been reached. Bit 2: Reserved 0. Bit 3: Reserved 0. Bit 4: Measuring. The instrument is actively measuring.
<b>MEASure</b>		
2.	[:PRESsure] [z]?	Returns the pressure in the current units from the specified sensor, or active sensor if [z] is omitted.
3.	:TEMPerature[z]?	Returns the temperature in deg. C. from the specified sensor, or active sensor if [z] is omitted.
4.	:RATE[z]?	Returns the pressure rate in the current units from the specified sensor, or active sensor if [z] is omitted.
5.	:BAROmetric?	Returns the barometric pressure in the current unit, if a barometer sensor is installed.
<b>CALibration</b>		
6.	[:PRESsure] [z]	
7.	:MODE?	Returns 1 if the sensor has been calibrated or 0 if not.
8.	:DATE?	Returns the stored calibration date.
9.	:DATE <i,i,i>	Sets the calibration date (YYYY,MM,DD).
10.	:ZERO?	Returns current zero point correction in bar.
11.	:ZERO <n>	Sets the zero so the currently measured pressure matches the commanded value in the current unit. Limited to +/-5% FS.
12.	:ZERO:RUN	Vents the instrument and sets zero so the currently measured pressure = 0.
13.	:ZERO:STOP	
14.	:ZERO:INITiate	
15.	:ZERO:INITiate?	

GB

14235993.00/06/2017/GB

## 8. Remote Operation

Item	Command or Query	Response/Function
<b>SENSE</b>		
16.	[:PRESsure] [z]	Selects the sensor to read or modify or active sensor if [z] is omitted.
17.	:NAME?	Returns the accuracy and range of the sensor.
18.	:MODE?	Returns pressure type "ABSOLUTE" or "GAUGE"
19.	:MODE ABS/GAUGE	Sets the pressure type to absolute or gauge.
20.	:ABS?	Returns native sensor type "1" for absolute, "0" for gauge.
21.	:RESolution?	Returns the FS-related relative resolution of the sensor.
<b>:RANGe</b>		
22.	[:UPPer]?	Returns the maximum range of the primary sensor.
23.	:LOWer?	Returns the minimum range of the primary sensor.
<b>:Unit</b>		
24.	[:NAME]?	Returns a string representing the native units of the sensor.
25.	:VALue?	Returns the conversion factor of the native units of the sensor to the current unit.
<b>:REFerence</b>		
26.	[:HEIGHt] <n>	Sets the head height correction [mm].
27.	:HEIGHt?	Returns the head pressure height.
28.	:MODE?	Returns head correction mode - "OFF", "GAS", LIQUIT".
29.	:MODE OFF/GAS/LIQUIT	Sets the head correction mode.
30.	:MEDIUM <n>	Sets the density of the medium at 20°C & 1bar(abs) [kg/m3] (or equivalent value in current units).
31.	:MEDIUM?	Returns medium.
32.	:ACTive <n>	Sets the active sensor
33.	:ACTive?	Returns the active sensor
<b>SYSTem</b>		
34.	:DATE <i,i,i>	Sets the system date (YYYY,MM,DD).
35.	:DATE?	Returns system date YYYY,MM,DD
36.	:TIME <i,i,i>	Sets the system time (hh,mm,ss).
37.	:TIME?	Returns system time HH,MM,SS.
38.	:ERRor[:NEXT]?	Return: error#, "description".
39.	:KLOCK ON/OFF/1/0	Lock or unlock keyboard.
40.	:PRESet	Load default values
41.	:SAVe	Saves settings to non-volatile memory.
42.	:VERSion?	Return of the SCPI-standard.
<b>TEST</b>		
43.	:ELECTronic?	Returns "OK".
44.	:RELay<n>?	Returns whether relay 1 to 3 is closed or not.
45.	:RELay<n> ON/OFF	Turns relay 1 to 3 on or off.

## 8. Remote Operation

Item	Command or Query	Response/Function
<b>UNIT</b>		
46.	:NAME<n>?	Returns the name of the unit with index n.
47.	:FACTOR<n>?	Returns the conversion factor to the current unit with index n.
48.	:PRESsure<n>	Sets the pressure units.
49.	:PRESsure?	Returns the pressure units.
<b>OUTPut</b>		
50.	:STATeON/OFF/1/0	ON or 1 = Control OFF or 0 = Measure
51.	:STATe?	Returns 0 for measure 1 for control.
52.	:MODE MEASure/CONTrol/VENT	Sets the mode indicated.
53.	:MODE?	Returns the mode string.
54.	:STABLE?	Returns 1 if stable 0 if not.
55.	:AUTOvent ON/OFF/1/0	Puts the unit in the Vent mode if true
56.	:AUTOvent?	Returns the state of the Vent mode.
57.	:AUTORange ON/OFF/1/0	Turns autorange on or off
58.	:AUTORange?	Returns "ON" or "OFF"
<b>[SOURce]</b>		
:PRESsure		
[:LEVel]		
[:IMMediate]		
59.	[:AMPLitude] <n>	Sets the setpoint.
60.	[:AMPLitude]?	Returns the setpoint.
61.	:SLEW <n>	Sets the slew rate setpoint.
62.	:SLEW?	Returns the slew rate setpoint.
63.	:TOLerance <n>	Sets the stable window.
64.	:TOLerance?	Returns the stable window.
<b>CALCulate</b>		
:LIMit		
65.	:LOWer<n>	Sets minimum control limit.
66.	:LOWer?	Returns minimum control limit.
67.	:UPPer<n>	Sets maximum control limit.
68.	:UPPer?	Returns maximum control limit.
:SYSTem		
69.	:DETECT SLOW/FAST/CANCEL	Control autotune <b>(NOT USED NOW)</b> .
70.	:DETECT?	Returns state of control autotune.

GB

14235993.00/06/2017/GB

### 8.4.1 SCPI Error Messages and Error Codes

A recognized command is displayed at the device in the headline with “Remote...”. In case of error “Remote error...” is displayed. A maximum of 100 errors are stored and can be retrieved successfully.

Table 10 Error Codes SCPI

Code	Error String Return
0	No error
-101	Undefined character
-102	Syntax error
-103	Undefined separator
-104	Parameter data type error
-109	Parameter missing
-110	Undefined header
-113	Undefined command
-114	Parameter out of range
-313	Calibration data not found
-315	Configuration data not found
-350	Errorqueue overflow
-410	Query interrupted
600	Default configuration not found
601	Calibration mode active! Deactivate before setting C0..C3
602	Sensor not available
701	DCS instance not available
702	Create DCS instance failed
703	DCS still active
704	Command currently not allowed



## 9. Calibration

### 9.1 Calibration Environment

For maximum accuracy, allow the CPC8000-H to warm up for a minimum of 25 minutes in an ambient temperature within the compensated range prior to commencing a calibration. In addition the instrument should be at rest on a stable platform that is free of excessive vibration and shock.

GB

### 9.2 Calibration Pressure Standards

Mensor recommends the use of appropriately accurate pressure standards when calibrating this instrument. Such standards should be sufficient so that when the techniques of the ISO Guide to the Expression of Uncertainty in Measurement (GUM) are applied, the instrument meets its accuracy statements as required by ISO/IEC 17025:2005, or other applicable standards.

### 9.3 Calibration Media

For calibration of the hydraulic reference pressure sensor of the CPC8000-HM the fluid used in the controller is recommended is required.

For calibration of the internal pneumatic control sensor of the CPC8000-HC and the barometric reference gas media are required. The recommended medium is dry nitrogen or clean, dry, instrument air.

### 9.4 Calibration Setup

Refer to the calibration setup illustration on the following page (see Figure 9-1 Absolute pressure calibration). The illustration shows a typical calibration setup for absolute and gauge pressure instruments. The 'Pressure Standard' is normally a deadweight tester, a precision piston balance or a precision manometer. The 'Volume Controller' refers to a hand operated variable-volume pressure vernier device.

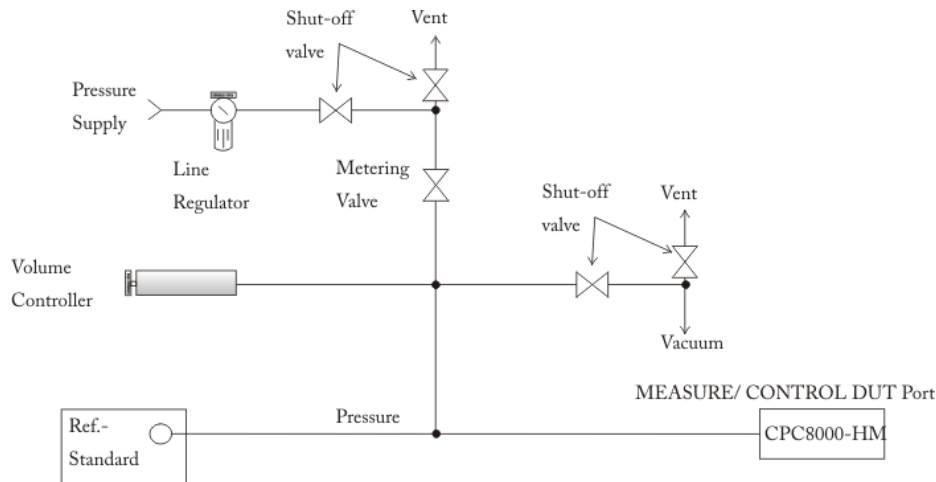

Figure 9-1 Absolute pressure calibration

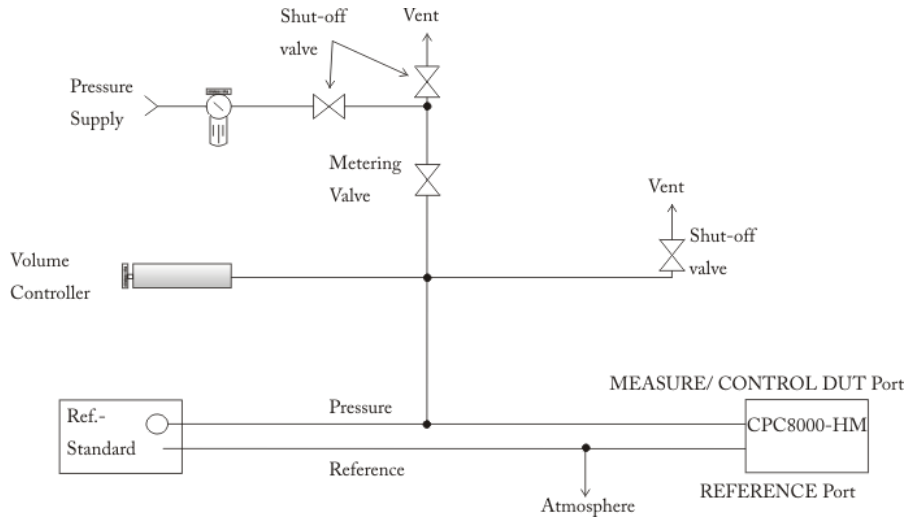

Figure 9-2 Gauge pressure calibration

## 9.5 Calibration Adjustment Procedure

There are three methods that can be used to calibrate all of the transducers in the CPC8000-H. A simple [1-Point Calibration] can be used to adjust a single point (usually the zero point). A [2-Point Calibration] extends this capability to adjust two points (usually points close to the Zero and Span). The [Linearize] calibration provides a way to calibrate and linearize the pressure curve using from 1 to 10 points over the range of each transducer.

Procedures for use and interaction with all the calibration screens can be found in the following sections of this manual:

- 1 Point Calibration — See Section 9.5.1
- 2 Point Calibration — See Section 9.5.2
- Linearize Calibration — See Section 9.5.3
- Head Correction — See Section 7.3.5.2



### INFORMATION!

When calibrating the CPC8000-H, adjust for the difference in level between the pressure standard and the instrument (head) must be considered. See Section 7.3.5.2 to view and adjust the head correction.

### 9.5.1 1-Point Calibration

The 1 Point Calibration screen provides a place to calibrate an internal sensor or the optional barometer using a single pressure point. This is usually done to adjust the zero point of a sensor. The sensor being calibrated is chosen by pressing the [Primary], [Secondary], [Tertiary] or [Barometer] tab at the bottom of the screen.

With a gauge sensor the instrument is simply vented using the [Vent] button and, after a stable pressure is seen, 0 (zero) is entered by pressing the [New Value] button which will open a numeric key pad.

With an absolute sensor, the instrument should be put in [Measure] mode with an appropriate high accuracy reference standard connected to the Measure/Control DUT port on the back of the CPC8000-HM. The value for the absolute pressure reading from the reference standard should be recorded by pressing the [New Value] button.



Figure 9-3 1 point calibration

A certificate number can be entered by pressing the [certificate] button. The date can be entered by pressing the [Date] button. The calibration interval can be viewed and changed by pressing the [Interval] button.

### 9.5.2 2-Point Calibration

A 2 Point Calibration adjusts both the “zero” (low point) and the “span” (high point) of the active transducer.

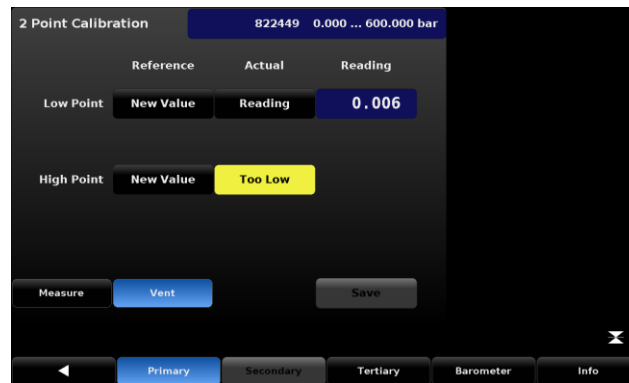

Figure 9-4 2 point calibration

Follow the steps below for a complete 2 Point Calibration:

1. Select a Transducer to calibrate by pressing one of the available transducer tabs at the bottom of the screen, in this case [Primary] [Secondary], [Tertiary], or [Barometer].
2. Insure that the head correction is adjusted properly (see Section 7.3.5.2).
3. The 2 point calibration screen is accessed through the password protected portion of the Setup [ ]/[Applications] area. See Section 7.5.1 for the default password.
4. To calibrate the “low Point”:
  - a. The Measure /Control port of the instrument should be supplied with a suitable, “low point” pressure (see 4.5 Rear Panel, for the port location).
  - b. For a gauge transducer, this low point pressure can be achieved by Pressing the [Vent] button on the 2 Point calibration screen and wait for the reading to stabilize at, or close to, zero.
  - c. The pressure should be measured at a stable value that is within 20% of the minimum range of the selected internal transducer.
  - d. When the pressure is stable the [Reading] button, under the “Actual” label and on the row labeled “Low Point”, should be pressed. This action accepts the value and it will appear with a green background where the [Reading] button was.
  - e. Press the [New Value] button and, via the numeric key pad, enter the “true pressure” obtained from the calibration standard. After the value has been accepted by pressing the [check] mark on the numeric key pad the value will appear with a green

## 9. Calibration

background where the [New Value] button was. These actions complete the low point calibration.

5. To calibrate the "High Point":
  - a. The "High Point" Calibration is done in a similar way as the "Low Point" but should be performed in [Measure] mode.
  - b. Place the instrument in Measure mode by pressing the [Measure] button within the 2 point Calibration Screen.
  - c. Supply a pressure to the Measure/Control Port using a pressure standard. This pressure should be as close as possible to the full scale value of the selected transducer or at least within 20% of that value. The [Too Low] button will change to a [Reading] button when the pressure reaches an acceptable range.
  - d. After the pressure stabilizes, select the [Reading] button to accept the instrument's reading of the pressure input. The actual reading will appear within a green background where the [Reading] button was.
  - e. Press the [New Value] button and enter the "true pressure". This value is obtained from the pressure measured by the calibration standard. After the value has been accepted by pressing the check [ ] mark on the numeric key pad, the value will appear with a green background where the [New Value] button was. These actions completes the High Point calibration.
  - f. The [Save] button will now be active, press it to store the values in the transducer.

### 9.5.3 Linearize

The [Linearize] application (see "Figure 9-5 Linearization - As found") provides a place to record [As Found] calibration data and to linearize each internal transducer in the CPC8000-H using that data. An "as found calibration" can be performed by connecting a suitable pressure standard to the Measure/Control port, placing the instrument in [Measure] mode and supplying up to 10 pressure points (1-11) within the range of the transducer being calibrated. The record of the pressures generated or measured by the pressure standard and the corresponding reading from the instrument's transducer can be recorded and transcribed into the [Linearize] / [As Found] screen. The screen is accessed by pressing the [As Found] button in the {Linearize} screen.

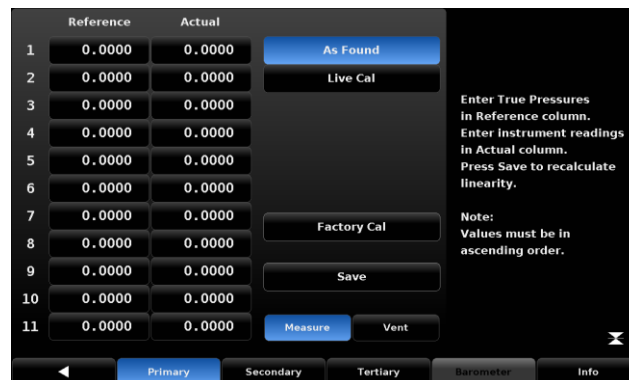

Figure 9-5 Linearization - As found

In the [Linearize] / [As Found] screen choose the transducer to be linearized by pressing the [Primary], [Secondary], [Tertiary], or [Barometer] button. Pressure test points generated by the reference standard are entered in the column labeled "Reference"; each of the corresponding readings from the instrument's transducer should be entered into the column labeled "Actual". To enter readings, simply press the corresponding point in the "Reference" or "Actual" columns and a data entry keypad will appear on the side bar. Enter and accept the point using the key pad and check [ ]. Pressing the [Save] button linearizes the internal sensor based on the "As Found" data entered. Linearization can also be accomplished for each transducer in a "live Calibration" by pressing the [Linearize] / [Live Cal] button. The Live Cal allows the calibration technician to perform the calibration and linearization for each sensor in a more direct way. In the Live Cal, the reference standard is connected to the Measure/Control port and the CPC8000-H is placed in Measure mode. Choose the transducer to be tested by pressing the [Primary], [Secondary], [Tertiary], or [Barometer] button. The reference pressure generated by the standard is recorded in the "Reference" column for each point. The reading

## 9. Calibration

of the internal transducer for each pressure point can be seen directly in the “Reading” window. Pressing the corresponding point under the “Actual” column will accept that reading into that point. Subsequent pressure points generated by the pressure standard are accepted and recorded in the same way. After all points are entered, press the [Save] button to linearize the internal sensor based on the “Live Cal” data.

GB

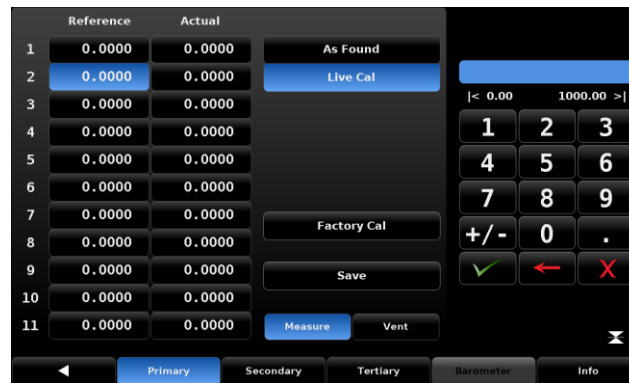

Figure 9-6 Linearization - Live cal

At any time the [Factory Cal] button can be pressed to revert back to the factory calibration.

# 10. Maintenance, cleaning and service

## 10.1 Maintenance

This instrument is maintenance-free.

Repairs must only be carried out by the manufacturer.

The safety of the operator may be endangered by the low-pressure controller if, for example:

- there is visible damage to the instrument.
- the instrument is not working as specified.
- the instrument has been stored under unsuitable conditions for an extended period of time.

If there is any doubt, please return the low-pressure controller to the manufacturer for repair or maintenance.

## 10.2 Cleaning



### CAUTION!

- Before cleaning, correctly disconnect the instrument from the pressure supply, switch it off and disconnect it from the mains.
- Clean the instrument with a moist cloth.
- Electrical connections must not come into contact with moisture.
- Wash or clean the dismantled instrument before returning it, in order to protect staff and the environment from exposure to residual media.
- Residual media in dismantled instruments can result in a risk to persons, the environment and equipment. Take sufficient precautionary measures.



For information on returning the instrument see chapter 12.2 Return

## 10.3 Recalibration

DKD/DAkkS certificate - Certificates:

We recommend that the instrument is regularly recalibrated by the manufacturer, with time intervals of approx. 12 months. Every factory recalibration includes, additionally, an extensive free-of-charge check of all system parameters with respect to their compliance with the specification. The basic settings will be corrected if necessary.

### 10.4 Transducer location

The following graphic shows the location of the internal reference sensors

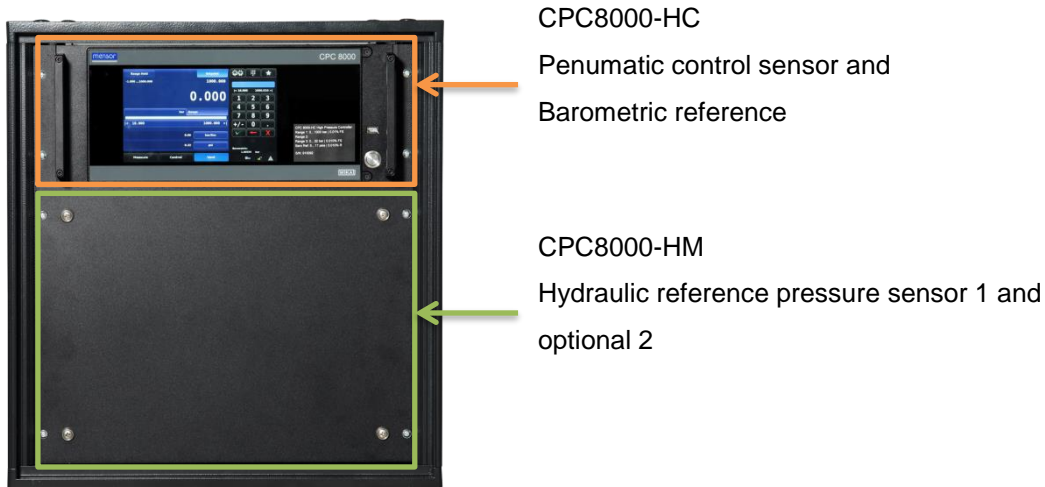

GB

#### 10.4.1 CPC8000-HM Transducer Removal / Replacement

The front panel can be removed by losing 8 screws to get access to the internal reference sensors. Before opening the front panel, the system has to be turned off.

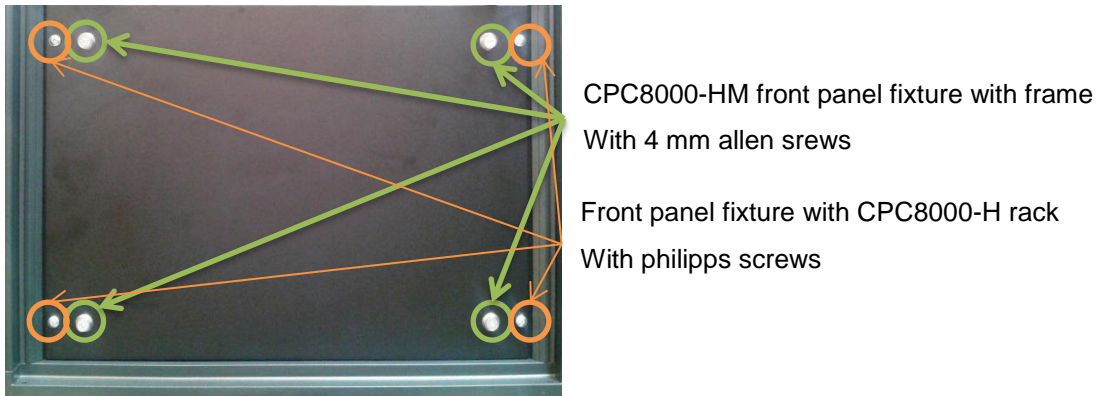

**CAUTION!**

Before removing the transducers, correctly disconnect the instrument from the pressure supply, switch it off and disconnect it from the mains.



**CAUTION!**

Further access to the interior of the instrument is NOT allowed. There are no user-serviceable plumbing or parts inside. In addition to the dangerous voltages present (line voltage), there are circuits sensitive to electrostatic discharge damage. There are also several solenoid valves which will run hot enough to cause painful burns under certain operating conditions. These dangerous conditions will be avoided by limiting interior access to the areas that are exposed by opening the front panel.

14235993.00/06/2017/GB

## 10. Maintenance, cleaning and service

GB

Loose the four screws which fix the CPC8000-HM at the rack as well as the four screws which fix the CPC8000-HM front panel and remove the entire front panel. Lose the 9-pin D-sub connector from the side of the sensor. Disconnect the hydraulic tubing at the sensor. Then use a 3mm Allen wrench to loosen the two cap screws near the base of the transducer which fix the sensor on the base plate. Pull the sensor out the front.

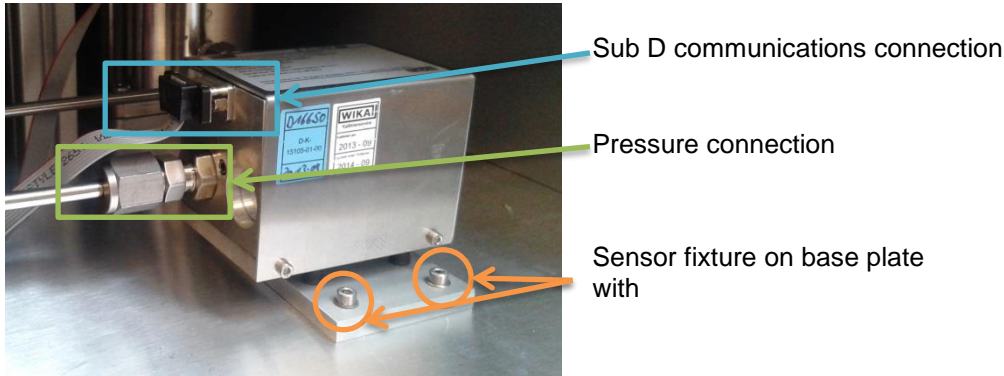

To return the module, or a replacement module to the system slide it firmly back into position to engage the hydraulic passages with those in the manifold, tighten the two retaining cap screws, and connect the communication/power D-sub connector.

### 10.4.2 CPC8000-HC Transducer Removal / Replacement

The front panel is hinged to allow access to the self-contained pressure transducers. To open the front panel, first turn off system power, then loosen the two (captive) screws near the right hand edge of the panel. The panel can then swing away to reveal the transducers lined up across the interior.

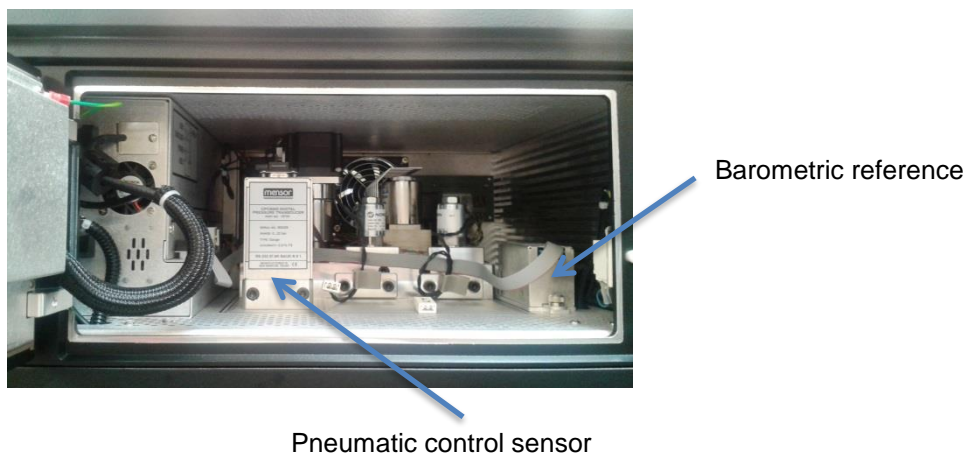

If the system has not been powered down, opening the front panel will trip an interlock to vent the system to atmosphere.



#### CAUTION!

Further access to the interior of the instrument is NOT allowed. There are no user-serviceable plumbing or parts inside. In addition to the dangerous voltages present (line voltage), there are circuits sensitive to electrostatic discharge damage. There are also several solenoid valves which will run hot enough to cause painful burns under certain operating conditions. These dangerous conditions will be avoided by limiting interior access to the areas that are exposed by opening the front panel.

To remove a transducer from the system, swing the front panel open and disconnect the 9-pin D-sub connector from its top. Then use the supplied 3/16 inch Allen wrench to loosen the two cap screws near the base of the transducer. With both screws disengaged, slide the transducer toward the front opening to disconnect it from the manifold. If an optional Barometric transducer is present it will



## 10. Maintenance, cleaning and service

occupy a slot to the far right and will be secured in place with a thumb screw. Loosen the thumb screw and lift the sensor up and over the retaining pin. Each pressure or barometer module is totally self-contained and including the pressure sensor and all of its calibration data.

To return the module, or a replacement module to the system slide it firmly back into position to engage the pneumatic passages with those in the manifold, tighten the two retaining cap screws, and connect the communication/power D-sub connector. To replace the optional barometer, slide it back into place over the retaining pin and tighten the thumb screw. Finally, secure the front panel and test that the system is operational.

The system has the opportunity to install two more pneumatic pressure sensors but they are not planned and used in this configuration. This is why each slot which is not used is plugged with a plate. The 9-pin D-sub connector which are not used have to be disconnected.

GB

### 10.5 CPC8000-HC Removal



#### CAUTION!

Before removing the transducers, correctly disconnect the instrument from the pressure supply, switch it off and disconnect it from the mains.

Disconnect all electronic and pneumatic connections as well as the mains plug at the CPC8000-HC. Remove the four philipps screws at the front of the CPC8000-HC which fix the instrument in the rack. Pull the instrument out the rack.

### 10.6 CPC8000-HM Removal



#### CAUTION!

The CPC8000-HM is heavy. The weight is about 90 kg/ 198 lbs.



#### CAUTION!

Before removing the CPC8000-HM, correctly disconnect the instrument from the pressure supply, switch it off and disconnect it from the mains.



#### CAUTION!

At least two persons have to carry the instrument during the removal process.



#### Wear safety shoes!

Wear safety shoes when working at the CPC8000-HM

Disconnect all electronic and pneumatic connections as well as the mains plug at the CPC8000-HM. Remove the four philipps screws at the front of the CPC8000-HC which fix the instrument in the rack. Pull the instrument with at least two persons out the rack.

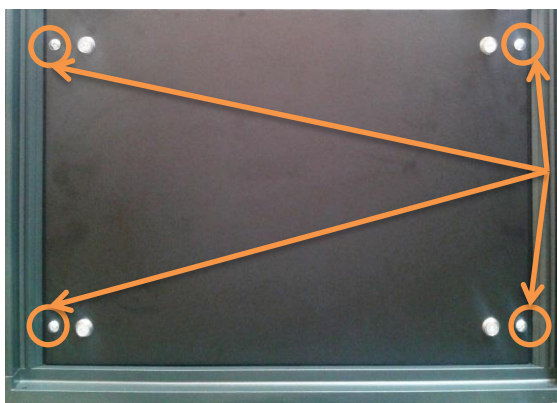

Front panel fixture with CPC8000-H rack  
With philipps screws

14235993.00/06/2017/GB

## 11. Faults

Item	Problem	Correct Action
1.	The system has been switched on and no measurement(s) have appeared and the entire area of the screen is white (or dark).	Switch the system off. Wait 5 seconds and switch the system on.
2.	The screen is dark and the corrective action for #1 above has no effect	Check that the power cable is connected properly and have authorized technical staff check that the supply voltage is correct.
3.	The screen is dark and the action taken to solve the problem of #2 above has no effect.	Unplug the unit from the power source (wall socket), then remove the power cord from the instrument. The power cord input socket includes two internal fuses. Check both fuses for continuity.
		 <p><b>WARNING!</b> Use only 2.5 amp 250V SLO-BLO 5x20 Fuse</p>
4.	Malfunction during operation.	Switch the system off. Wait 5 seconds and switch the system on.
5.	Unstable control.	Consult factory
6.	The setpoint value is not reached.	Check whether the value of the supply pressure is the value required, and leak test the plumbing.

If you need help or assistance:

### WIKA Alexander Wiegand SE & Co. KG

- Internet address: [www.wika.com](http://www.wika.com)
- Relevant data sheet: CT28.01
- Application consultant: Tel.: (+49) 9372/132-9986  
Fax: (+49) 9372/132-8767  
E-Mail: [info@wika.de](mailto:info@wika.de)

### Mensor Corporation

- Internet address: [www.mensor.com](http://www.mensor.com)
- Relevant data sheet: CT28.01
- Application consultant: Tel.: (+1) 512-396-4200  
(+1) 800-984-4200  
Fax: (+1) 512-396-1820  
E-Mail: [sales@mensor.com](mailto:sales@mensor.com)  
[tech.support@mensor.com](mailto:tech.support@mensor.com)



### CAUTION!

If faults cannot be eliminated by means of the measures listed above, the low-pressure controller must be shut down immediately, and it must be ensured that pressure and/or signal are no longer present, and it must be prevented from being inadvertently put back into service. In this case, contact the manufacturer.

If a return is needed, please follow the instructions given in chapter 12.2 Return

### 12. Dismounting, return and disposal



**WARNING!**

Residual media in dismantled instruments can result in a risk to persons, the environment and equipment. Take sufficient precautionary measures.

#### 12.1 Dismounting



**WARNING!**

Risk of burns!

Let the instrument cool down sufficiently before dismantling it! When dismantling it, there is a risk that dangerously hot pressure media may escape.

Only disconnect the pressure measuring instrument/measuring assembly once the system has been depressurized!

#### 12.2 Return



**WARNING!**

**Absolutely observe when shipping the instrument:**

All instruments delivered to WIKA must be free from any kind of hazardous substances (acids, bases, solutions, etc.).

When returning the instrument, use the original packaging or a suitable transport package.

**To avoid damage:**

- Place the instrument, along with the shock-absorbent material, in the packaging.
- Place shock-absorbent material evenly on all sides of the shipping box.
- If possible, place a bag, containing a desiccant, inside the packaging.
- Label the shipment as transport of a highly sensitive measuring instrument.

Enclose the completed return form with the instrument.



The return form is available on the internet:

[www.wika.de / Service / Return](http://www.wika.de/Service/Return)

#### 12.3 Disposal

Incorrect disposal can put the environment at risk.



For disposal of the used media, please observe the material safety data sheet of the manufacturer.

Dispose of instrument components and packaging materials in an environmentally compatible way and in accordance with the country-specific waste disposal regulations.

## 13. Appendix

### 13.1 Conversion factors, pascal

The following table lists factors which should be used as multipliers when converting other pressure units to or from Pascal.

Item	Pressure Unit	To convert from Pascal	To convert to Pascal
1.	PSI	1.450377E-04	6.894757E+03
2.	inHg 0°C	2.952997E-04	3.386390E+03
3.	inHg 60°F	2.961339E-04	3.376850E+03
4.	inH <sub>2</sub> O 4°C	4.014741E-03	2.490820E+02
5.	inH <sub>2</sub> O 20°C	4.021862E-03	2.486410E+02
6.	inH <sub>2</sub> O 60°F	4.018645E-03	2.488400E+02
7.	ftH <sub>2</sub> O 4°C	3.345622E-04	2.988980E+03
8.	ftH <sub>2</sub> O 20°C	3.351551E-04	2.983692E+03
9.	ftH <sub>2</sub> O 60°F	3.348871E-04	2.986080E+03
10.	mTorr	7.500636E+00	1.333220E-01
11.	inSW 0°C 3.5% sal	3.904899E-03	2.560885E+02
12.	ftSW 0°C 3.5% sal	3.254082E-04	3.073062E+03
13.	ATM	9.869230E-06	1.013250E+05
14.	Bar	1.00000E-05	1.00000E+05
15.	mBar	1.00000E-02	1.00000E+02
16.	mmH <sub>2</sub> O 4°C	1.019744E-01	9.806378E+00
17.	cmH <sub>2</sub> O 4°C	1.019744E-02	9.806378E+01
18.	MH <sub>2</sub> O 4°C	1.019744E-04	9.806378E+03
19.	mmHg 0°C	7.500636E-03	1.333220E+02
20.	cmHg 0°C	7.500636E-04	1.333220E+03
21.	Torr	7.500636E-03	1.333220E+02
22.	kPa	1.00000E-03	1.00000E+03
23.	PA	1.00000E+00	1.00000E+00
24.	Dy/cm <sup>2</sup>	1.00000E+01	1.00000E-01
25.	gm/cm <sup>2</sup>	1.019716E-02	9.806647E+01
26.	kg/cm <sup>2</sup>	1.019716E-05	9.806647E+04
27.	MSW 0°C 3.5% sal	9.918444E-05	1.008222E+04
28.	OSI	2.320603E-03	4.309223E+02
29.	PSF	2.088543E-02	4.788025E+01
30.	TSF	1.044271E-05	9.576052E+04

14235993.00/06/2017/GB

## 13. Appendix

Item	Pressure Unit	To convert from Pascal	To convert to Pascal
32.	μHg 0°C	7.500636E+00	1.333220E-01
33.	TSI	7.251885E-08	1.378951E+07
35.	hPa	1.00000E-02	1.00000E+02
36.	MPa	1.00000E-06	1.00000E+06
37.	mmH2O 20°C	1.021553E-01	9.789017E+00
38.	cmH2O 20°C	1.021553E-02	9.789017E+01
39.	MH2O 20°C	1.021553E-04	9.789017E+03

GB

14235993.00/06/2017/GB

## North America

### Canada

WIKA Instruments Ltd.  
Head Office  
Edmonton, Alberta, T6N 1C8  
Tel. (+1) 780 46370-35  
Fax: (+1) 780 46200-17  
E-Mail: [info@wika.ca](mailto:info@wika.ca)  
[www.wika.ca](http://www.wika.ca)

### Mexico

Instrumentos WIKA Mexico S.A. de C.V.  
01210 Mexico D.F.  
Tel. (+52) 55 55466329  
E-Mail: [ventas@wika.com](mailto:ventas@wika.com)  
[www.wika.com.mx](http://www.wika.com.mx)

### USA

WIKA Instrument Corporation  
Lawrenceville, GA 30043  
Tel. (+1) 770 5138200  
Fax: (+1) 770 3385118  
E-Mail: [info@wika.com](mailto:info@wika.com)  
[www.wika.com](http://www.wika.com)

### WIKA Instrument Corporation

Houston Facility  
950 Hall Court  
Deer Park, TX 77536  
Tel. (+1) 713-475 0022  
Fax (+1) 713-475 0011  
E-mail: [info@wikahouston.com](mailto:info@wikahouston.com)  
[www.wika.com](http://www.wika.com)

### Mensor Corporation

201 Barnes Drive  
San Marcos, TX 78666  
Tel. (+1) 512 3964200-15  
Fax (+1) 512 3961820  
E-Mail: [sales@mensor.com](mailto:sales@mensor.com)  
[www.mensor.com](http://www.mensor.com)

## South America

### Argentina

WIKA Argentina S.A.  
Buenos Aires  
Tel. (+54) 11 47301800  
Fax: (+54) 11 47610050  
E-Mail: [info@wika.com.ar](mailto:info@wika.com.ar)  
[www.wika.com.ar](http://www.wika.com.ar)

### Brazil

WIKA do Brasil Ind. e Com. Ltda.  
CEP 18560-000 Iperó - SP  
Tel. (+55) 15 34599700  
Fax: (+55) 15 32661650  
E-Mail: [marketing@wika.com.br](mailto:marketing@wika.com.br)  
[www.wika.com.br](http://www.wika.com.br)

### Chile

WIKA Chile S.P.A.  
Av. Coronel Pereira, 101, Oficina 101  
Las Condes  
Santiago de Chile  
Tel. (+56) 9 66084258  
Fax (+56) 2 3346219  
E-Mail: [info@wika.cl](mailto:info@wika.cl)  
[www.wika.cl](http://www.wika.cl)

## Asia

### China

WIKA Shanghai Office  
A2615, NO.100, Zuyi Road  
Changning District  
200051 Shanghai  
Tel. (+86) 21 538525-72  
Fax: (+86) 21 538525-75  
E-Mail: [info@wika.com.cn](mailto:info@wika.com.cn)  
[www.wika.com.cn](http://www.wika.com.cn)

### India

WIKA Instruments India Pvt. Ltd.  
Village Kesnand, Wagholi  
Pune - 412 207  
Tel. (+91) 20 66293-200  
Fax: (+91) 20 66293-325  
E-Mail: [sales@wika.co.in](mailto:sales@wika.co.in)  
[www.wika.co.in](http://www.wika.co.in)

### Japan

WIKA Japan K. K.  
Tokyo 105-0023  
Tel. (+81) 3 543966-73  
Fax: (+81) 3 543966-74  
E-Mail: [info@wika.co.jp](mailto:info@wika.co.jp)

### Kazakhstan

WIKA Kazakhstan LLP  
169, Rayimbek avenue  
050050 Almaty, Kazakhstan  
Tel. (+7) 32 72330848  
Fax: (+7) 32 72789905  
E-Mail: [info@wika.kz](mailto:info@wika.kz)  
[www.wika.kz](http://www.wika.kz)

### Korea

#569-21 Gasan-dong  
Seoul 153-771 Korea  
Tel. (+82) 2 869 05 05  
Fax (+82) 2 869 05 25  
E-Mail: [info@wika.co.kr](mailto:info@wika.co.kr)  
[www.wika.co.kr](http://www.wika.co.kr)

### Malaysia

WIKA Instrumentation (M) Sdn. Bhd.  
47100 Puchong, Selangor  
Tel. (+60) 3 80 63 10 80  
Fax: (+60) 3 80 63 10 70  
E-Mail: [info@wika.com.my](mailto:info@wika.com.my)  
[www.wika.com.my](http://www.wika.com.my)

### Singapore

WIKA Instrumentation Pte. Ltd.  
569625 Singapore  
Tel. (+65) 68 44 55 06  
Fax: (+65) 68 44 55 07  
E-Mail: [info@wika.com.sg](mailto:info@wika.com.sg)  
[www.wika.com.sg](http://www.wika.com.sg)

### Taiwan

WIKA Instrumentation Taiwan Ltd.  
Pinjen, Taoyuan  
Tel. (+886) 3 420 6052  
Fax: (+886) 3 490 0080  
E-Mail: [info@wika.com.tw](mailto:info@wika.com.tw)  
[www.wika.com.tw](http://www.wika.com.tw)

## Africa / Middle East

### Egypt

WIKA Near East Ltd.  
El-Serag City Towers  
-Tower#2 - Office#67-  
Nasr City Cairo  
Tel. (+20) 2 22733140  
Fax: (+20) 2 22703815  
E-Mail: [wika\\_repair@wika.de](mailto:wika_repair@wika.de)  
[www.wika.com.eg](http://www.wika.com.eg)

### Namibia

WIKA Instruments Namibia (Pty) Ltd.  
P.O. Box 31263  
Pionierspark  
Windhoek  
Tel. (+26) 4 6123 8811  
Fax (+26) 4 6123 3403  
E-Mail: [info@wika.com.na](mailto:info@wika.com.na)  
[www.wika.com.na](http://www.wika.com.na)

### South Africa

WIKA Instruments (Pty.) Ltd.  
Gardenview,  
Johannesburg 2047  
Tel. (+27) 11 62100-00  
Fax: (+27) 11 62100-59  
E-Mail: [sales@wika.co.za](mailto:sales@wika.co.za)  
[www.wika.co.za](http://www.wika.co.za)

### United Arab Emirates

WIKA Middle East FZE  
Jebel Ali, Dubai  
Tel. (+971) 4 8839-090  
Fax: (+971) 4 8839-198  
E-Mail: [wikame@emirates.net.ae](mailto:wikame@emirates.net.ae)

## Australia

### WIKA Australia Pty. Ltd.

Rydalmere, NSW 2116  
Tel. (+61) 2 88455222  
Fax: (+61) 2 96844767  
E-Mail: [sales@wika.com.au](mailto:sales@wika.com.au)  
[www.wika.com.au](http://www.wika.com.au)

### New Zealand

WIKA Instruments Limited  
Unit 7 / 49 Sainsbury Road  
St Lukes - Auckland 1025  
Tel. (+64) 9 8479020  
Fax: (+64) 9 8465964  
E-Mail: [info@wika.co.nz](mailto:info@wika.co.nz)  
[www.wika.co.nz](http://www.wika.co.nz)

## Europe

**Austria**

WIKA Messgerätevertrieb  
Ursula Wiegand GmbH & Co. KG  
1230 Vienna  
Tel. (+43) 1 86916-31  
Fax: (+43) 1 86916-34  
E-Mail: [info@wika.at](mailto:info@wika.at)  
[www.wika.at](http://www.wika.at)

**Benelux**

WIKA Benelux  
6101 WX Echt  
Tel. (+31) 475 535-500  
Fax: (+31) 475 535-446  
E-Mail: [info@wika.nl](mailto:info@wika.nl)  
[www.wika.nl](http://www.wika.nl)

**Bulgaria**

WIKA Bulgaria EOOD  
Bul. „Al. Stamboliiski“ 205  
1309 Sofia  
Tel. (+359) 2 82138-10  
Fax: (+359) 2 82138-13  
E-Mail: [t.antonov@wika.bg](mailto:t.antonov@wika.bg)

**Croatia**

WIKA Croatia d.o.o.  
Hrastovicka 19  
10250 Zagreb-Lucko  
Tel. (+385) 1 6531034  
Fax: (+385) 1 6531357  
E-Mail: [info@wika.hr](mailto:info@wika.hr)  
[www.wika.hr](http://www.wika.hr)

**Finland**

WIKA Finland Oy  
00210 Helsinki  
Tel. (+358) 9-682 49 20  
Fax: (+358) 9-682 49 270  
E-Mail: [info@wika.fi](mailto:info@wika.fi)  
[www.wika.fi](http://www.wika.fi)

**France**

WIKA Instruments s.a.r.l.  
95610 Eragny-sur-Oise  
Tel. (+33) 1 343084-84  
Fax: (+33) 1 343084-94  
E-Mail: [info@wika.fr](mailto:info@wika.fr)  
[www.wika.fr](http://www.wika.fr)

**I****taly**

WIKA Italia Srl & C. Sas  
20020 Arese (Milano)  
Tel. (+39) 02 9386-11  
Fax: (+39) 02 9386-174  
E-Mail: [info@wika.it](mailto:info@wika.it)  
[www.wika.it](http://www.wika.it)

**Poland**

WIKA Polska S.A.  
87-800 Wloclawek  
Tel. (+48) 542 3011-00  
Fax: (+48) 542 3011-01  
E-Mail: [info@wikapolska.pl](mailto:info@wikapolska.pl)  
[www.wikapolska.pl](http://www.wikapolska.pl)

**Romania**

WIKA Instruments Romania S.R.L.  
Bucuresti, Sector 5  
Calea Rahovei Nr. 266-268  
Corp 61, Etaj 1  
78202 Bucharest  
Tel. (+40) 21 4048327  
Fax: (+40) 21 4563137  
E-Mail: [m.anghel@wika.ro](mailto:m.anghel@wika.ro)

**Russia**

ZAO WIKA MERA  
127015 Moscow  
Tel. (+7) 495-648 01 80  
Fax: (+7) 495-648 01 81  
E-Mail: [info@wika.ru](mailto:info@wika.ru)  
[www.wika.ru](http://www.wika.ru)

**Serbia**

WIKA Merna Tehnika d.o.o.  
Sime Solaje 15  
11060 Belgrade  
Tel. (+381) 11 2763722  
Fax: (+381) 11 753674  
E-Mail: [info@wika.co.yu](mailto:info@wika.co.yu)  
[www.wika.co.yu](http://www.wika.co.yu)

**Spain**

Instrumentos WIKA, S.A.  
C/Josep Carner, 11-17  
08205 Sabadell (Barcelona)  
Tel. (+34) 933 938630  
Fax: (+34) 933 938666  
E-Mail: [info@wika.es](mailto:info@wika.es)  
[www.wika.es](http://www.wika.es)

**Switzerland**

Manometer AG  
6285 Hitzkirch  
Tel. (+41) 41 91972-72  
Fax: (+41) 41 91972-73  
E-Mail: [info@manometer.ch](mailto:info@manometer.ch)  
[www.manometer.ch](http://www.manometer.ch)

**Turkey**

WIKA Instruments Istanbul  
Basinc ve Sicaklik Ölçme Cihazlari  
Ith. Ihr. ve Tic. Ltd. Sti.  
Bayraktar Bulvarı No. 21  
34775 Yukari Dudullu - Istanbul  
Tel. (+90) 216 41590-66  
Fax: (+90) 216 41590-97  
E-Mail: [info@wika.com.tr](mailto:info@wika.com.tr)  
[www.wika.com.tr](http://www.wika.com.tr)

**Ukraine**

WIKA Pribor GmbH  
83016 Donetsk  
Tel. (+38) 062 34534-16  
Fax: (+38) 062 34534-17  
E-Mail: [info@wika.ua](mailto:info@wika.ua)  
[www.wika.ua](http://www.wika.ua)

**United Kingdom**

WIKA Instruments Ltd  
Merstham, Redhill RH13LG  
Tel. (+44) 1737 644-008  
Fax: (+44) 1737 644-403  
E-Mail: [info@wika.co.uk](mailto:info@wika.co.uk)  
[www.wika.co.uk](http://www.wika.co.uk)

**WIKAL Alexander Wiegand SE & Co. KG**

Alexander-Wiegand-Straße 30  
63911 Klingenberg • Germany  
Tel. (+49) 9372/132-0  
Fax (+49) 9372/132-406  
E-Mail [info@wika.de](mailto:info@wika.de)  
[www.wika.de](http://www.wika.de)