

Digital Deadweight Tester, Model CPD8500

EN



Digital Deadweight Tester, Model CPD8500



Part of your business

© 03/2020, Mensor, LP. All rights reserved.

Mensor is a registered trademark of Mensor, LP.

All other brand and product names are trademarks or registered trademarks of their respective companies.

Prior to starting any work, read the operating instructions!

Keep for later use!

Contents

1. General Information	7
1.1 Warranty	7
1.2 Radio Frequency Emission Notices	8
1.2.1 FCC Emission Notice	8
1.2.2 CE Emission Notice	8
1.3 Software License Agreement	8
1.4 Mensor Service Plus	9
1.4.1 After the Warranty	9
1.4.2 Calibration Services	9
1.4.3 Certifications and Accreditations	9
2. Short Overview	10
2.1 Features	10
2.2 Components	11
2.2.1 Base	11
2.2.2 CPS8500 Measuring Head	11
2.2.3 Environmental Monitoring Module	11
2.2.4 Drive Motor	11
2.3 Turning On	11
2.4 Front Panel	12
2.4.1 Power Switch	12
2.4.2 USB Port	13
2.5 Display	13
2.6 Scope of Delivery	13
3. Safety	14
3.1 Explanation of Symbols	14
3.2 Intended Use	14
3.3 Improper Use	15
3.4 Responsibility of the Operator	15
3.5 Personnel Qualification	15
3.6 Personal Protective Equipment	16
3.7 Labeling, Safety Marks	16
3.7.1 Product Label	16
3.7.2 Symbols	17
3.8 Warnings and Cautions	17
4. Transport, Packaging and Storage	18
4.1 Transport	18
4.2 Packaging and storage	18
4.2.1 Transport of Measuring Heads CPS8500	19
5. Installation	21
5.1 Mounting	21
5.2 Leveling	21
5.3 Push Rod Selection	22
5.4 CPS8500 Measuring Head Installation	23
5.4.1 Legacy 610 and CPS8500A Absolute Measuring Head	23
5.4.2 Legacy 410/110 and CPS8500G Gauge Measuring Heads	25
5.5 Head Temperature Probe Installation	29
5.6 Motor Installation	30
5.7 Process Connections	30

5.7.1	Onboard Memory	30
5.7.2	CPS8500A Low Pressure Absolute Heads	31
5.7.3	Legacy 610 Low Pressure Absolute Heads	31
5.7.4	Low Pressure Zero Setup	33
5.7.4.1	Zeroing & Spanning Setup	33
5.7.4.2	Operational Setup	33
5.7.5	CPS8500A High Pressure Absolute Heads	33
5.7.6	Legacy High Pressure Absolute Heads	34
5.7.6.1	Zeroing & Spanning Setup	35
5.7.6.2	Operational Setup	35
5.7.7	Gauge Heads	35
5.7.7.1	Zeroing & Spanning Setup	36
5.7.7.2	Operational Setup	36
5.7.8	Switching Measuring Heads	36
5.8	Head to Base Adaptation	36
5.8.1	CPS8500A to Gauge Base	36
5.8.2	CPS8500G to Absolute Base	38
5.9	Rear Panel	39
5.9.1	Reference Supply Port	40
5.9.2	Optional: Barometric Reference Port	40
5.9.3	Remote Communication Connections.	40
6.	Operation	41
6.1	General Operation	41
6.1.1	Power Up	41
6.1.2	Setup Applications	41
6.1.3	Display Screen Features	41
6.2	Initial Setup.	43
6.2.1	Local Gravity Setup	43
6.2.2	Contact and Version Information Application	43
6.2.3	Language Selection	44
6.2.4	Active Head Selection	44
6.2.5	Head Motor Activation	46
6.3	Application Selection and Parameter Inputs.	47
6.4	Applications	48
6.4.1	Home Applications	48
6.4.1.1	Current Pressure Reading	49
6.4.1.2	Units and Pressure Type.	50
6.4.1.3	Zero	50
6.4.1.4	Span	52
6.4.1.5	sBar Graph	54
6.4.1.6	Auxiliary Displays	54
6.4.1.7	Uptime Clock	54
6.4.1.8	Tare Button	55
6.4.1.9	Active Head	55
6.4.1.10	Barometer	55
6.4.2	Settings Application.	56
6.4.2.1	Languages	56
6.4.2.2	Brightness	57
6.4.2.3	User Base Units/ Base Units Multiplier	57
6.4.2.4	Barometer Units	58

6.4.2.5	Configuration	58
6.4.3	Limits Application	59
6.4.3.1	Ambient Tolerance Limits	59
6.4.3.2	Head Temperature Limit	60
6.4.3.3	Pressure Stability Parameters	60
6.4.4	Display Settings Application	61
6.4.4.1	Reading Filter	61
6.4.4.2	Reading Resolution	62
6.4.4.3	Bar Graph	62
6.4.4.4	Tare	62
6.4.4.5	Uptime Clock	63
6.4.5	Head Information Application	63
6.4.5.1	Head Information for CPS8500A and CPS8500G	64
6.4.5.2	Remote Command Set	66
6.4.5.3	Remote Communication Settings.	67
6.4.6	Information Application	68
6.4.7	Troubleshooting Application	69
6.4.8	Service Application	70
7.	Remote Operation	72
7.1	Remote Operating Parameters	72
7.2	Command Set.	72
7.3	IEEE-488	72
7.3.1	IEEE-488.2 Commands	72
7.4	Ethernet	72
7.5	Serial.	73
7.5.1	Serial Cable Requirements	73
7.6	Mensor Command Set	74
7.6.1	Command and Query Format	74
7.6.2	Command Set Definitions	74
7.6.3	Output Formats	74
7.6.4	Mensor Commands and Queries	75
7.6.5	Units Command Syntax for Measurement Units	80
7.7	CPD8000 Command Set	81
7.7.1	Command and Query Format	81
7.7.2	Command Set Definitions	81
7.7.3	CPD8500 Commands and Queries	81
7.8	Error Codes	83
8.	Maintenance and Recalibration	86
8.1	Maintenance	86
8.1.1	Beyond the Warranty	86
8.1.2	Measuring Head Cleaning	86
8.1.2.1	CPS8500A Absolute Measuring Head	86
8.1.2.2	CPS8500G Gauge Measuring Head.	89
8.1.2.3	Legacy Absolute Measuring Head	93
8.1.2.4	Low Pressure Gauge Measuring Head	96
8.1.2.5	High Pressure Gauge Measuring Head.	99
8.1.3	Spare Parts	103
8.1.3.1	Environmental Monitoring Module Replacement	103
8.1.3.2	Absolute Accessory Kit Replacement	104

8.1.3.3	Gauge Accessory Kit Replacement	104
8.1.3.4	Vacuum Transducer Replacement	104
8.1.3.5	Barometric Reference Replacement	106
8.2	Recalibration	107
8.2.1	Calibration Services by Mensor or WIKA worldwide	107
8.2.2	Environment	107
8.2.2.1	Pressure Calibration Setup for CPD8500	107
8.2.3	Pressure Standards	108
8.2.4	Media	108
8.2.5	Calibration Data	108
8.2.6	Calibration Application	109
8.2.6.1	One Point Calibration	110
8.2.6.2	Two Point Calibration	112
8.2.7	Mass Calibration Application	115
8.2.8	Head Settings Application	117
8.2.8.1	New Head Addition	119
8.2.9	Reference Level	120
9.	Dismounting, Return and Disposal	121
9.1	Dismounting	121
9.2	Return	122
9.3	Disposal	122
10.	Specifications	123
10.1	Measuring Head	123
10.2	Base Instrument	124
10.3	Approvals and Certificates	125
10.4	Dimensions in mm (in)	126
10.4.1	Absolute	126
10.4.2	Gauge	127
11.	Accessories	128
11.1	Barometric Reference Sensor	128
11.1.1	Bidirectional Pressure Emulation	128
11.1.2	Emulation Mode Accuracy	128
11.1.3	Barometric Reference Calibration	128
11.2	Vacuum Transducer	128
11.3	Absolute Accessory Kit	129
11.4	Vacuum Pump Requirements	131
11.5	Gauge Accessory Kit	131
11.6	Upgrade Accessory Kit	131
11.7	External Mass Set	132
11.8	EMM Calibration Sled	132
11.9	Barometric Reference Calibration Sled	133
12.	Appendix	134
12.1	Measurement Units	134
12.2	Conversion Factors, PSI	135
12.3	Conversion Factors, Millitorr	136
12.4	Conversion Factors, Pascal	137

Declarations of conformity can be found online at www.wika.com.

1. General information

1. General Information

- The CPD8500 digital deadweight tester described in the operating instructions has been designed and manufactured using state-of-the-art technology. All components are subject to stringent quality and environmental criteria during production. Our management systems are certified to ISO 9001 and ISO 14001.
- These operating instructions contain important information on handling the instrument. Working safely requires that all safety instructions and work instructions are observed.
- Observe the relevant local accident prevention regulations and general safety regulations for the instrument's operating range.
- The operating instructions are part of the instrument and must be kept in the immediate vicinity of the instrument and readily accessible to skilled personnel at any time. Pass the operating instructions onto the next operator or owner of the instrument.
- Skilled personnel must have carefully read and understood the operating instructions prior to beginning any work.
- The general terms and conditions contained in the sales documentation shall apply.
- Subject to technical modifications.
- Factory calibrations / A2LA / DKD/DAkkS calibrations are carried out in accordance with international standards.

■ Further information:

Mensor Corporation

- Address: 201 Barnes Dr., San Marcos, TX 78666
- Internet address: www.mensor.com
- Relevant data sheet: CT 32.05
- Application consultant: Tel.: (+1) 512-396-4200
(+1) 800-984-4200 (USA only)
Fax: (+1) 512-396-1820
E-Mail: sales@mensor.com
techservices@mensor.com

Importer for Europe

WIKA Alexander Wiegand SE & Co. KG

- Address: Alexander Wiegand-Straße
63911 Klingenberg, Germany
- Internet address: www.wika.de / www.wika.com
- Relevant data sheet: CT 32.05
- Application consultant: Tel.: (+49) 9372/132-5015
Fax: (+49) 9372/132-8767
E-Mail: CTsales@wika.com

1.1 Warranty

All products manufactured by Mensor are warranted to be free of defects in workmanship and materials for a period of two years from the date of shipment. No other express warranty is given, and no affirmation of Seller, by words or actions, shall constitute a warranty. SELLER DISCLAIMS ANY IMPLIED WARRANTIES OF MERCHANTABILITY OR FITNESS FOR ANY PARTICULAR

EN

1. General Information

EN

PURPOSES WHATSOEVER. If any defect in workmanship or material should develop under conditions of normal use and service within the warranty period, repairs will be made at no charge to the original purchaser, upon delivery of the product(s) to the factory, shipping charges prepaid. If inspection by Mensor or its authorized representative reveals that the product was damaged by accident, alteration, misuse, abuse, faulty installation or other causes beyond the control of Mensor, this warranty does not apply. The judgment of Mensor will be final as to all matters concerning condition of the product, the cause and nature of a defect, and the necessity or manner of repair. Service, repairs or disassembly of the product in any manner, performed without specific factory permission, voids this warranty.

LIMITED WARRANTY applies to any CPD8500 manufactured as an upgrade of an existing CPD8000/DPG10. Any reused parts including but not limited to the internal load cell, vacuum box and the enclosed components are excluded from Mensor's Warranty coverage.

MENSOR MAKES NO WARRANTY OF ANY KIND WITH REGARD TO THIS MANUAL, INCLUDING, BUT NOT LIMITED TO, THE IMPLIED WARRANTIES OF MERCHANTABILITY AND FITNESS FOR A PARTICULAR PURPOSE. Mensor shall not be liable for errors contained herein or for incidental or consequential damages in connection with the furnishing, performance, or use of this material.

1.2 Radio Frequency Emission Notices



USE SHIELDED CABLES TO CONNECT EXTERNAL DEVICES TO THIS INSTRUMENT TO MINIMIZE RF RADIATION

1.2.1 FCC Emission Notice

This equipment has been tested and found to comply with the limits for a Class A digital device, pursuant to part 15 of the FCC Rules. These limits are designed to provide reasonable protection against harmful interference when the equipment is operated in a commercial environment. This equipment generates, uses, and can radiate radio frequency energy and, if not installed and used in accordance with the instruction manual, may cause harmful interference to radio communications. Operation of this equipment in a residential area is likely to cause harmful interference in which case the user will be required to correct the interference at his or her own expense.

1.2.2 CE Emission Notice

This equipment is of the emission class A, intended for operation in industrial environments. It can cause interference under certain circumstances if operated in other environments, i.e. residential or commercial areas. In this case, the user may be asked to take appropriate measures to correct it.

1.3 Software License Agreement

This product contains intellectual property, i.e. software programs, that are licensed for use by the end user/customer (hereinafter "end user").

This is not a sale of such intellectual property.

The end user shall not copy, disassemble or reverse compile the software program.



The software programs are provided to the end user "as is" without warranty of any kind, either express or implied, including, but not limited to, warranties of merchantability and fitness for a particular purpose. The entire risk of the quality and performance of the software program is with the end user.

Mensor and its suppliers shall not be held to any liability for any damages suffered or incurred by the end user (including, but not limited to, general, special, consequential or incidental damages including damages for loss of business profits, business interruption, loss of business information and the like), arising from or in connection with the delivery, use or performance of the software program.

PN 0019408001G 06/2022 EN

1. General Information

1.4 Mensor Service Plus

1.4.1 After the Warranty

Mensor's concern with the performance of this instrument is not limited to the warranty period. We provide complete repair, calibration and certification services after the warranty for a nominal fee.

1.4.2 Calibration Services

In addition to servicing our own products Mensor can perform a complete pressure calibration service, up to 30,075 psi hydraulically and 11,600 psi pneumatically, for all of your pressure instruments. This service includes an accredited calibration.

1.4.3 Certifications and Accreditations

Mensor is registered to ISO 9001:2015. The calibration program at Mensor is accredited by A2LA, as complying with both the ISO/IEC 17025:2017 and the ANSI/NCSL Z540-1-1994 standards.

EN

2. Short Overview

2. Short Overview

EN

The CPD8500 digital deadweight tester is a digital primary pressure standard, which combines the metrological performances of traditional deadweight testers with the convenience of digital interface and transfer standards. It can be used to calibrate a variety of precision pressure devices such as pressure controllers, calibrators, indicators and transducers in either absolute or gauge pressure modes. The CPD8500 has two different chassis and multiple head options to cover absolute and gauge pressure types with a high accuracy class. The optional internal or external barometer allows easy zeroing and pressure type emulation. The CPD8500 digital deadweight tester's measuring principle lies in the fundamental equation defining pressure:

$$P = F / A$$

It is based on the connection of a piston-cylinder assembly, with surface area A , to a high accuracy electronic measuring cell, which measures the force F .

Pressure is applied on the piston producing a proportional force that is transferred to the measuring cell. The measuring cell permanently measures the pressure-generated force. The force applied to the measuring cell creates an imbalance in a magnetic field. The electrical power needed to restore the magnetic field's balance is interpreted by a microprocessor to display a pressure value.

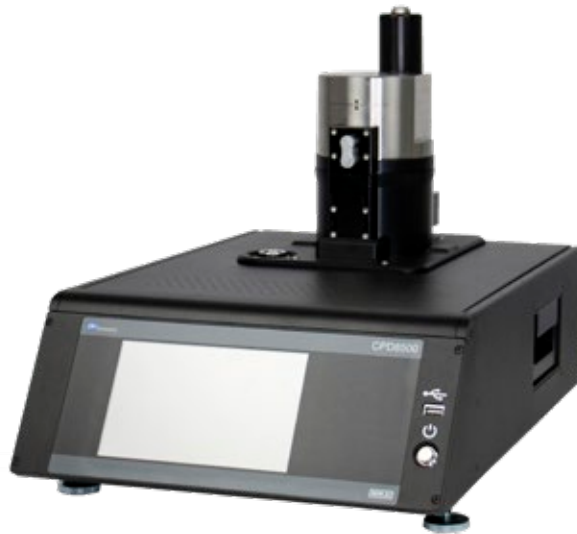

Figure 2.1 CPD8500 Gauge Version

2.1 Features

Here is a short list of significant features designed into the CPD8500:

- Highly accurate and linear internal load cell for mass measurement with zero and span adjustment capability
- Operating pressure range from 0... 500 bar gauge (0 ... 7,250 psi) and 0 20 bar absolute (290 psi)
- Up to 35 ppm measurement accuracy
- Interchangeable measuring heads with onboard calibration coefficients for maximum accuracy and resolution
- Removable environmental monitoring module for accurate ambient pressure, temperature and humidity feedback
- An optional removable / interchangeable internal high accuracy barometric reference transducer providing absolute pressure emulation for gauge ranges
- 7" color LCD with touch screen
- Support for multiple head configurations on one chassis
- Multiple languages; change the language for on-screen text and number/date formats by simply touching one of the "national flag" icons available in the setup screen.
- Desk top
- Easy level adjustment

PN 0019408001G 06/2022 EN

2. Short overview

2.2 Components

2.2.1 Base

The base is composed of:

- The measuring load cell, which measures the force applied by the head
- The Environmental Monitoring Module
- The electronic assembly which ensures stable pressure calculation, the display as well as remote communication
- Optional internal barometric reference for pressure emulation
- Precision vacuum sensor (absolute base only) for detection of stable vacuum pressure
- The lubrication valves to automatically switch the lubrication circuit of the measuring head from atmospheric pressure to the measured pressure
- Bases that have a control board revision 2x or greater have an additional connector to allow communication to the CPS8500 head memory

2.2.2 CPS8500 Measuring Head

The measuring head CPS8500 is designed for containing, operating and protecting the piston-cylinder assembly. The measuring heads are designed to operate with pure gas with the piston cylinder being lubricated with gas only for absolute versions and gas or oil (depending on the range) for gauge versions. The measuring heads are available in various versions:

- CPS8500A - absolute head
- CPS8500G - gauge head
- Legacy 610 - absolute head
- Legacy 110 - low pressure gauge head
- Legacy 111 - medium pressure gauge head
- Legacy 410 - high pressure gauge head

Each measuring head is characterized by a nominal coefficient, K_n . This is a conversion factor specific to each measuring head, representing the pressure value per kilogram converted in proportion to the head's cross sectional area. This conversion factor is either represented in bar/ kg or psi/kg.

The CPS8500A and CPS8500G have all their necessary data stored in their memory board, allowing for more ease of use and less chance of losing critical data.

2.2.3 Environmental Monitoring Module

The Environmental Monitoring Module (EMM) accurately detects the ambient conditions and provide feedback to the electronic assembly inside the base for easy adaptation of measurements corresponding to any changes in ambient conditions. The EMM consists of an ambient pressure, temperature, head temperature remote probe and relative humidity sensor. The EMM continuously monitors the change in ambient conditions in real time. Whenever these conditions change outside of a tolerance that might noticeably alter the measuring performance, the CPD8500 recommends the user to perform a span and/or zero calibration for the internal load cell, this is explained in section 6.4.1.4.

2.2.4 Drive Motor

Stable pressure measurement requires the piston-cylinder assembly inside the measuring head to spin at a fixed rate. The CPD8500 supports either a brushed DC or a brushless DC motor.

2.3 Turning On

Apply power to the power connector on the rear of the base of the instrument with the included power cord, remove any plastic plugs from the rear panel pressure ports, and press the power switch to ON. The system will go through an initialization process, which takes about 1 minute, and then a display will appear similar to the screen shown below.

2. Short overview



EN



Figure 2.3



Earth Ground! Any power adapters or surge protection devices that negate the protective earth ground should not be used. The power cord must be accessible and contain a protective earth ground. Do not position the equipment so that it is difficult to remove the power cord.

To see information about the configuration of your new CPD8500, touch the Information Application (App) icon [] on the menu and a window will appear listing the Mensor contact information, model number and the transducers that are installed. Press the Home App [] to return to the main screen.

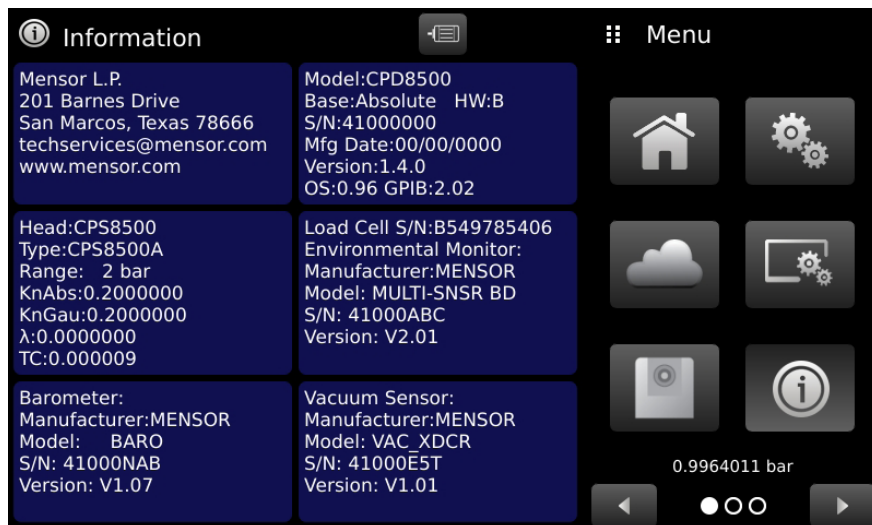

Figure 2.3 Information application

2.4 Front Panel

The CPD8500 front panel includes an 7" color LCD display with touch screen. Operator input is accomplished by pressing the words or symbols and the App icons presented on the display. There is a single discrete on/off button and a USB on the right hand side. The front panel also shows the model number designation and brand logos.

2.4.1 Power Switch

The power switch is a two-state device with an action similar to that of a ball point pen. Push the button with enough force to latch it in to turn the unit ON. Push it again to release it to turn the system OFF.



If power to the instrument is interrupted while ON it will shut down until the power is restored, then immediately resume operation.

PN 0019408001G 06/2022 EN

2. Short overview

2.4.2 USB Port

The front or rear panel USB port is the Host USB and is intended for software upgrades, loading new head information and future expansion. Section 6 Operation explains this in detail.

2.5 Display

The display is made up of two sections. In the main screen (“Home Application”), the left three fourths shows the operating screen displaying the active pressure reading, units, mode (absolute or gauge), active head information, an uptime clock (if enabled), a bar graph (if enabled), an auto zero, span and tare button (if enabled) and any auxiliary displays that have been chosen. The right one fourth of the screen has Application Icons (“Apps”) for setting general instrument settings, limits, display settings, head information, instrument information plus a “Next Page” button [▶] that, when pressed, shows a second and third page of icons for remote communication, troubleshooting and service applications.

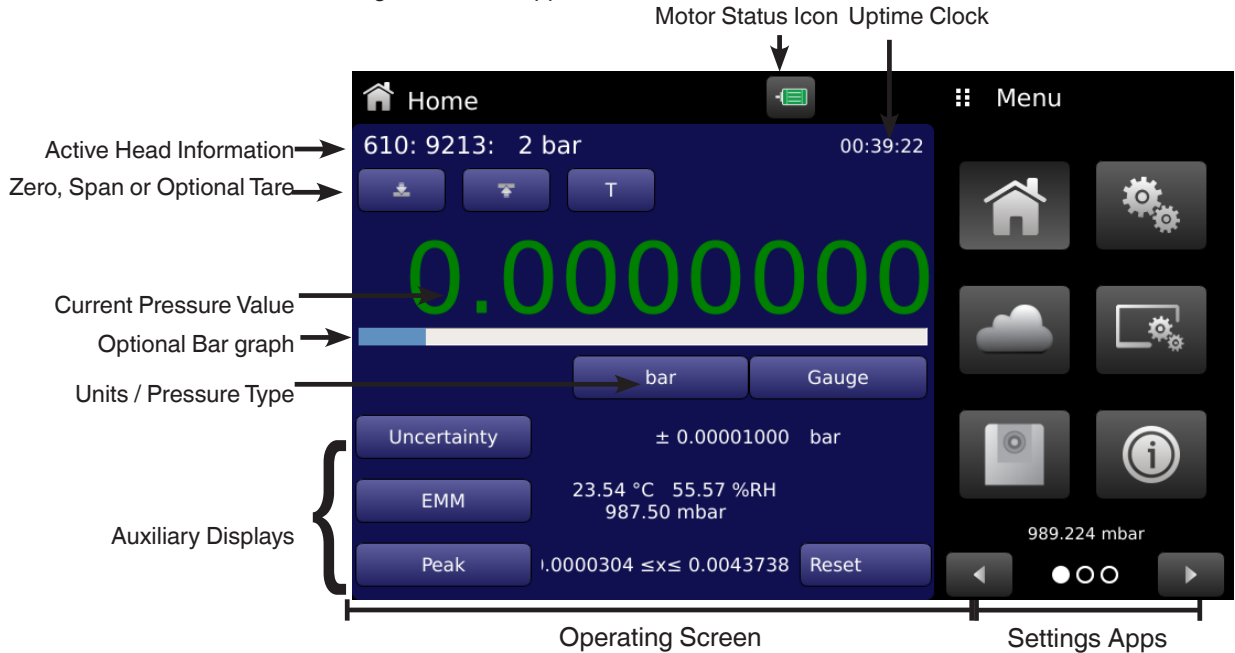

Buttons, Labels and Windows: The CPD8500 touch screen has many buttons with relevant graphic icons or text which, when touched, will open a related window where changes can be made or information viewed. Some of these buttons will toggle from one state to another, others present choices or display a numerical data entry screen. Text or icons that are displayed, but do not respond to being touched, are called labels or windows. Operators will quickly become accustomed to the particular characteristics of the frequently used buttons.

Main Screen: The main screen or “Home Application”, appears after power-up. This screen contains the operating screen and Settings application screen. It will remain as configured after a power cycle.

Operating screen: The operating screen (left 3/4 of the main screen) contains information relevant to the measurement. Up to three auxiliary displays can be shown simultaneously along with the current pressure value

2.6 Scope of Delivery

- Digital Deadweight Tester CPD8500 base
- Measuring Head CPS8500 (if ordered)
- Power cord with 1.5 m (5 ft) length
- Drive Motor
- Absolute accessory kit (if absolute unit ordered)
- Gauge accessory kit (if gauge unit ordered)
- Operating instruction
- USB with Head Information
- Factory calibration certificate

Cross-check scope of delivery with delivery note.

3. Safety

3. Safety

3.1 Explanation of Symbols

EN



DANGER!

... indicates a directly dangerous situation resulting in serious injury or death, if not avoided.



WARNING!

... indicates a potentially dangerous situation that can result in serious injury or death, if not avoided.



CAUTION!

... indicates a potentially dangerous situation that can result in light injuries or damage to property or the environment, if not avoided.



DANGER!

... identifies hazards caused by electrical power. Should the safety instructions not be observed, there is a risk of serious or fatal injury.



WARNING!

... indicates a potentially dangerous situation that can result in burns, caused by hot surfaces or liquids, if not avoided.



Information

... points out useful tips, recommendations and information for efficient and trouble-free operation.

3.2 Intended Use

The CPD8500 digital deadweight tester is designed to automate the testing and calibration of pressure devices and instruments for pressures up to 500 bar or 7,250 psi. The instrument allows measurement of absolute or gauge pressures with two different chassis and head type options.

This instrument is not permitted to be used in hazardous areas!

The instrument has been designed and built solely for the intended use described here, and may only be used accordingly.

The technical specifications contained in these operating instructions must be observed. Improper handling or operation of the instrument outside of its technical specifications requires the instrument to be taken out of service immediately and inspected by an authorized WIKA service engineer.

Handle electronic precision measuring instruments with the required care (protect from humidity, impacts, strong magnetic fields, static electricity and extreme temperatures, do not insert any objects into the instrument or its openings). Plugs and sockets must be protected from contamination.

The manufacturer shall not be liable for claims of any type based on operation contrary to the intended use.

PN 0019408001G 06/2022 EN

3.3 Improper Use



WARNING!

Injuries through improper use

Improper use of the instrument can lead to hazardous situations and injuries.

- ▶ Refrain from unauthorized modifications to the instrument.
- ▶ Do not use the instrument within hazardous areas.
- ▶ Do not use the instrument with abrasive or viscous media.

Any use beyond or different to the intended use is considered as improper use. Do not use this instrument in safety or emergency stop devices.

3.4 Responsibility of the Operator

The instrument is used in the industrial sector. The operator is therefore responsible for legal obligations regarding safety at work.

The safety instructions within these operating instructions, as well as the safety, accident prevention and environmental protection regulations for the application area must be maintained.

The operator is obliged to maintain the product label in a legible condition.

To ensure safe working on the instrument, the operating company must ensure that

- suitable first-aid equipment is available and aid is provided whenever required.
- the operating personnel are regularly instructed in all topics regarding work safety, first aid and environmental protection and know the operating instructions and in particular, the safety instructions contained therein.
- the instrument is suitable for the particular application in accordance with its intended use.
- personal protective equipment is available.

3.5 Personnel Qualification



WARNING!

Risk of injury should qualification be insufficient

Improper handling can result in considerable injury and damage to equipment.

- ▶ The activities described in these operating instructions may only be carried out by skilled personnel who have the qualifications described below.

Skilled personnel

Skilled personnel, authorized by the operator, are understood to be personnel who, based on their technical training, knowledge of measurement and control technology and on their experience and knowledge of country-specific regulations, current standards and directives, are capable of carrying out the work described and independently recognizing potential hazards.

Operating personnel

The personnel trained by the operator are understood to be personnel who, based on their education, knowledge and experience, are capable of carrying out the work described and independently recognizing potential hazards.

Special knowledge for working with instruments for hazardous areas:

The skilled (electrical) personnel must have knowledge of ignition protection types, regulations and provisions for equipment in hazardous areas.

Special operating conditions require further appropriate knowledge, e.g. of aggressive media.

3. Safety

3.6 Personal Protective Equipment

The personal protective equipment is designed to protect the skilled personnel from hazards that could impair their safety or health during work. When carrying out the various tasks on and with the instrument, the skilled personnel must wear personal protective equipment.

EN

Follow the instructions displayed in the work area regarding personal protective equipment!

The requisite personal protective equipment must be provided by the operating company.



Wear clean and protective gloves!

Protect the instrument from contamination.

3.7 Labeling, Safety Marks

3.7.1 Product Label

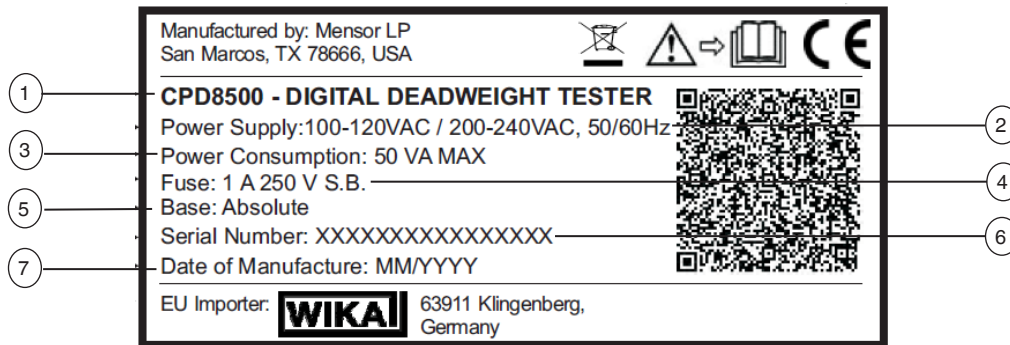

- | | |
|---------------------|-------------------------|
| ① Model | ⑤ Base type |
| ② Power supply | ⑥ Serial number |
| ③ Power consumption | ⑦ Date of manufacturing |
| ④ Fuse | |

3. Safety

3.7.2 Symbols



Before mounting and commissioning the instrument, ensure you read the operating instructions!



CE, Communauté Européenne
Instruments bearing this mark comply with the relevant European directives.



This marking on the instruments indicates that they must not be disposed of in domestic waste. The disposal is carried out by return to the manufacturer or by the corresponding municipal authorities (see EU directive 2012/19/EU).

3.8 Warnings and Cautions



WARNING!
HIGH PRESSURE! High pressure gases are potentially hazardous. Energy stored in these gases and liquids can be released suddenly and with extreme force. High pressure systems should be assembled and operated only by personnel who have been trained in proper safety practices.



WARNING!
NOT EXPLOSION PROOF! Installation of this instrument in an area requiring devices rated as intrinsically safe is not recommended.



WARNING!
POSSIBLE INJURY! The tubing, valves, and other apparatus attached to the gauge must be adequate for the maximum pressure which will be applied, otherwise physical injury to the operator or bystanders is possible.



CAUTION
USE THE PROPER PRESSURE MEDIUM! Use only clean, dry air or nitrogen unless otherwise specified by Mensor.



CAUTION
As with most sensitive electronic equipment, switch the power switch off before connecting or disconnecting to a power source to prevent data loss. Do not position the equipment so that it is difficult to disconnect the AC power cord.



WARNING!
Detachable main power supply cord with inadequate ratings should not be used. See Section 10. Specifications for power ratings.

Additional Warning and Caution notices are found throughout this manual.

4. Transport, Packaging and Storage

4. Transport, Packaging and Storage

4.1 Transport

Check the digital deadweight tester model CPD8500 for any damage that may have been caused by transport. Obvious damage must be reported immediately.

EN



CAUTION!

Damage through improper transport

With improper transport, a high level of damage to property can occur.

- ▶ When unloading packed goods upon delivery as well as during internal transport, proceed carefully and observe the symbols on the packaging.
- ▶ With internal transport, observe the instructions in chapter 4.2 “Packaging and storage”.

If the instrument is transported from a cold into a warm environment, the formation of condensation may result in instrument malfunction. Before putting it back into operation, wait for the instrument temperature and the room temperature to equalize.

4.2 Packaging and storage

The CPD8500 digital deadweight tester is packaged in a custom transport case especially designed to maintain the performances of the instrument in normal transportation conditions. Do not remove packaging until just before mounting.

The base, the measuring head, the drive motor along with all the accessories are located inside the transport case.

Keep the packaging as it will provide optimum protection during transport (e.g. change in installation site, sending for repair).

The transport case (Figure 4.2-A) can be maneuvered with a collapsible handle and wheels for ease of use.



Figure 4.2-A Transport Case for CPD8500

4. Transport, Packaging and Storage

The transport case must be laid on a flat surface with the handle side down and label side up. The case is opened with six flaps on three sides of the transport case. Once opened, the transport case houses all the components of the CPD8500 including accessories for absolute and gauge units. The base of the CPD8500 can be accessed by removing a protective foam (1) and then sliding hands on either side of the base in the slots (2). All other components can be gently removed from the transport case.

EN



Figure 4.2-B Contents of the Transport Case

- | | |
|---|--|
| ① Protective foam over the base | ⑤ CPS8500 measurement head |
| ② Hand slots for lifting the base | ⑥ CPD8500 motor |
| ③ CPD8500 base | ⑦ Oil bottle and syringe (only in gauge units) |
| ④ Flex vacuum tube slots (only in absolute units) | ⑧ Absolute accessory kit slot (only in absolute units) |

4.2.1 Transport of Measuring Heads CPS8500

There is a smaller case (figure 4.2.1) to support the transport of up to two measuring heads for the CPD8500. This case also provides an option to add measuring head specific accessories.

4. Transport, Packaging and Storage

EN



Figure 4.2.1 Transport Case for Two CPS8500

Permissible conditions at the place of storage:

- Storage temperature: -20 ... 70 °C
- Humidity: 35 ... 85 % relative humidity (no condensation)

Avoid exposure to the following factors:

- Direct sunlight or proximity to hot objects
- Mechanical vibration, mechanical shock (putting it down hard)
- Soot, vapor, dust and corrosive gases
- Hazardous environments, flammable atmospheres

5. Installation

Personnel: Skilled electrical and mechanical personnel

The following instructions must be followed in setting up the instrument for the first and any time after transporting to a different location



WARNING!
READ THESE INSTRUCTIONS BEFORE INSTALLATION!



WARNING!
Physical injuries and damage to property and the environment caused by hazardous media

Upon contact with hazardous media (e.g. oxygen, acetylene, flammable or toxic substances), harmful media (e.g. corrosive, toxic, carcinogenic, radioactive), and also with refrigeration plants and compressors, there is a danger of physical injuries and damage to property and the environment.

Should a failure occur, aggressive media with extremely high temperature and under high pressure or vacuum may be present at the instrument.

- ▶ For these media, in addition to all standard regulations, the appropriate existing codes or regulations must also be followed.
- ▶ Wear the requisite protective equipment (see chapter 3.6 “Personal protective equipment”).



CAUTION
Damage to the instrument

When working on open electrical circuits (printed circuit boards) there is a risk of damaging sensitive electronic components through electrostatic discharge.

- ▶ The correct use of grounded working surfaces and personal armbands is required.

5.1 Mounting

The Base must be set up on a solid, stable and level desk top surface. To assure stability and accuracy, avoid mounting the instrument on surfaces subject to motor or machinery vibration and far away from doors, windows, heating systems and air conditioning vents.



CAUTION
Avoid any vibrations and direct solar rays. Any significant temperature fluctuations would make the instrument unstable. Do not use the CPD8500 in explosive atmospheres, permanently humid or dusty environments.

5.2 Leveling

The leveling of the CPD8500 can be verified with the circular bubble level present on the top of the base (Figure 5.2). Repeatable measurement results can only be obtained if the CPD8500 is leveled. The leveling feet and the bubble level ensure the alignment of the instrument according to the mounting surface.

The alignment of the CPD8500 can be adjusted by screwing/ rotating the leveling feet at the maximum, then unscrewing the leveling foot (or feet) until the bubble is centered in the inner target.

5. Installation

EN

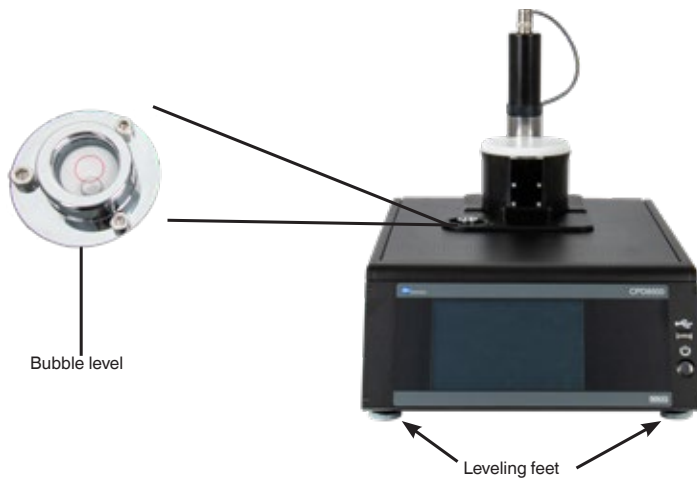

Figure 5.2

5.3 Push Rod Selection

The push rod is a mating piece that links the piston, inside the measuring head, to the load cell, inside the base. These come in 6 different variants (Fig. 5.3) and it is critical that the proper push rod is used with each measuring head. It is important to note the markings on each push rod to distinguish them apart from one another. All necessary push rods will be supplied with the head and/or base that is purchased. Please use the following images and table to confirm that the proper push rod is being used.

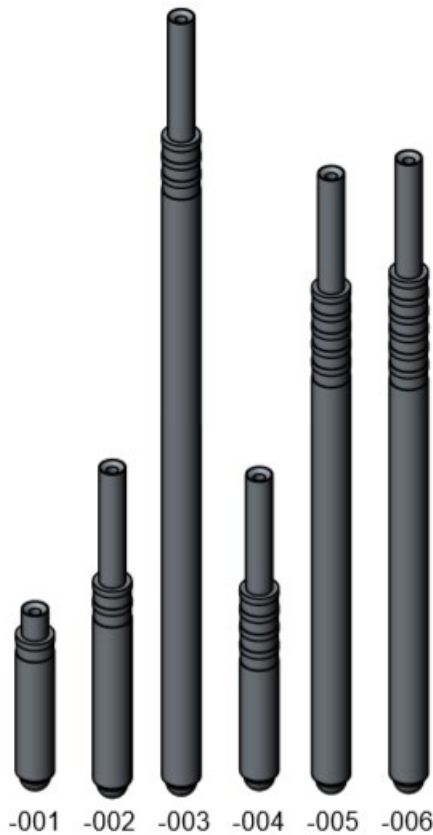

Figure 5.3 Push rods for all configurations

5. Installation

Base \ Head	Legacy 610	Legacy 110 and 111	Legacy 410	CPS8500A	CPS8500G
CPD8500 Absolute	-002	-005/-006 (note 1)	-006 (note 1)	-002	-004 (note 1)
CPD8500 Gauge	-002 (note 2)	-005/-006	-006	-002 (note 2)	-004

note 1: Requires optional gauge adapter

note 2: Gauge mode only

EN

5.4 CPS8500 Measuring Head Installation

The head installation instructions vary depending on the type of measuring head and the corresponding base of the CPD8500.



All the tools and components including hex screwdriver and base push rod are part of the accessory kit of the instrument. The details on these components can be found in Section 11.3 Absolute Accessory Kit and Section 11.5 Gauge Accessory Kit.

5.4.1 Legacy 610 and CPS8500A Absolute Measuring Head

These instructions are valid for the Legacy 610 and CPS8500A heads to be installed on an absolute base:



Wear clean and protective gloves!

Before removing the protective cap from the measurement head and base, wear gloves to protect and ensure uncontaminated use.

- Remove the white protective cap from the top of the base and the bottom of the Legacy 610 head (Figure 5.4.1-A shows the head with a protective cap attached) by inverting the measuring head such that the protective cap is on top and then unscrewing three hex screws. The Legacy 610 is shown in Figure 5.4.1-B with its top cover removed. The CPS8500A head with its protective cap attached is in Figure 5.4.1-C, and shown with the cap removed and inverted in Figure 5.4.1-D.



CAUTION

Care should be taken when CPD8500 base cover is removed to prevent contaminants from entering the system. Also, care should be taken to prevent touching the piston surface during installation.



CAUTION

The Legacy 610 head must be placed with the protective cap on top to ensure that the piston doesn't fall out of the cylinder.



Figure 5.4.1-A Legacy 610 with Top Cap



Figure 5.4.1-B Legacy 610 without Top Cap

5. Installation

EN

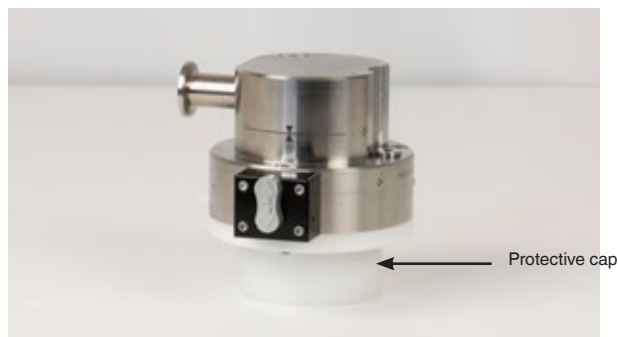

Figure 5.4.1-C CPS8500A with top cap

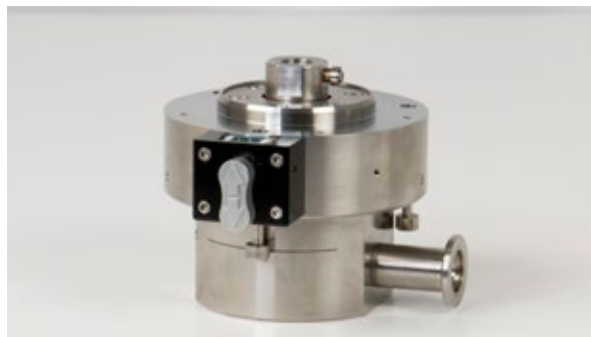

Figure 5.4.1-D CPS8500A inverted no cap

- Remove the white protective cap from the base of the instrument by removing the hex screws (Figure 5.4.1-D) and install the push rod on the base. The push rod must be installed with the ball side towards the base. After removing the protective cap, note the position of the ball bearing equipped with the piston head. This ball bearing is designed to drive the piston in rotation. The base of the instrument has a machined slot to receive this ball bearing (Figure 5.4.1-E). Align the head such that the ball bearing on the head is in line with the machined slot on the base. Also, be sure to align the head with the alignment pin in (Fig. 5.4.1-F). There is a hole on the measuring head that will fit into this pin.



Figure 5.4.1-E Protective cap on Base



Figure 5.4.1-F Machined slot in Base

- Align the CPS8500A with the machined slot in the base and the ball bearing from the bottom of the piston. The CPS8500A has a captured piston, so it will not fall out when the head is being placed on the base (Figure 5.4.1-G). The CPS8500A will then be tightened into place with the 5mm T-handle (Figure 5.4.1-H).



Figure 5.4.1-G Aligning the CPS8500A



Figure 5.4.1-H Fastening CPS8500A to the base

5. Installation

EN

- Visually align the head such that the ball bearing on the head matches the corresponding slot in base. With a Legacy 610 head, place a finger on the tip of the piston head to prevent it from dropping (Figure 5.4.2-E). Insert carefully the ball bearing in the matching slot and gently move your finger away while sliding the measuring head into the base (Figure 5.4.2-F). Secure the measuring head on to the head by screwing in the three hex screws (Figure 5.4.2-G).



Figure 5.4.2-E Legacy 610 aligning with base

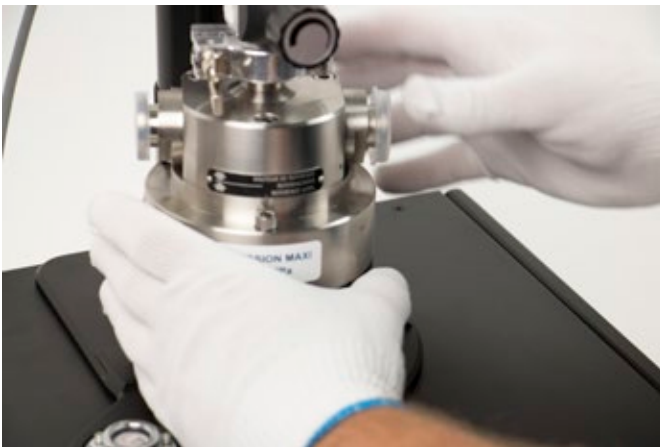

Figure 5.4.2-F Head attached to base

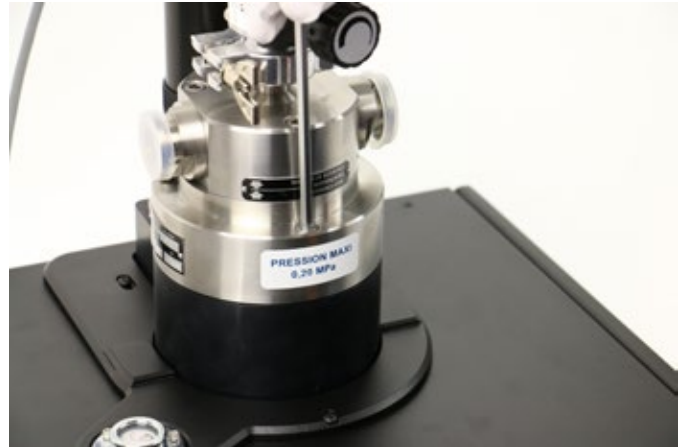

Figure 5.4.2-G Tighten screws on Head



CAUTION!

Always exert great care during this operation to prevent piston from dropping. Do not install the measuring head on the base when the motor is turned on.

5.4.2 Legacy 410/110 and CPS8500G Gauge Measuring Heads

These instructions are valid for gauge heads to be installed on gauge bases.

- Remove the white protective cap from the bottom of the measuring head by inverting the measuring head such that the protective cap is on top and then unscrewing three hex screws. The measuring head are shown in Figure 5.4.2-A with its top cover.



Figure 5.4.2-A Gauge Head with top cap

- The base is equipped with a white protective cover to protect the coupling system from contamination and damage. This protective cover must be removed before installing the measuring head on to the base. Simply push down on the cover and twist counter-clockwise to remove the base cover (Figure 5.4.2-B). Store this cover for future transportation of the instrument. Install the push rod on the base with the round side towards the base. Figure 5.4.2-C shows the base with the cover removed.

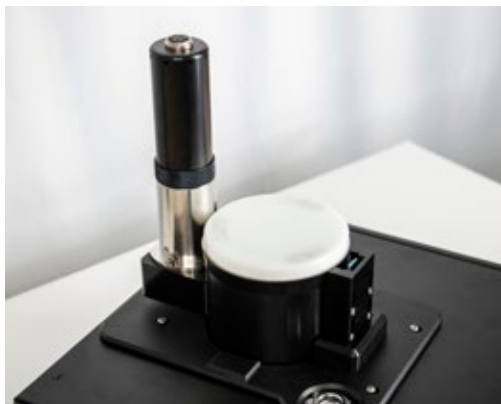

Figure 5.4.2-B Base cover

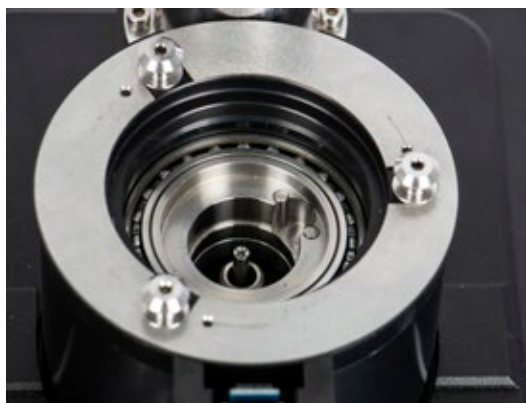

Figure 5.4.2-C Base without cover

5. Installation

EN

- The CPS8500G has an alignment mark that matches to the base. Align the mark on the base to the black vertical indentation mark on the head (Figure 5.4.2-D) and gently push the head on to the base and turn clockwise until secure (Figure 5.4.2-E).

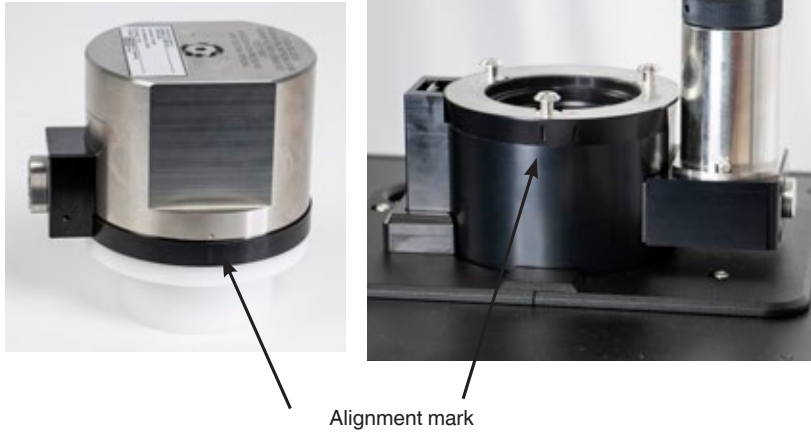

Figure 5.4.2-D Alignment Mark

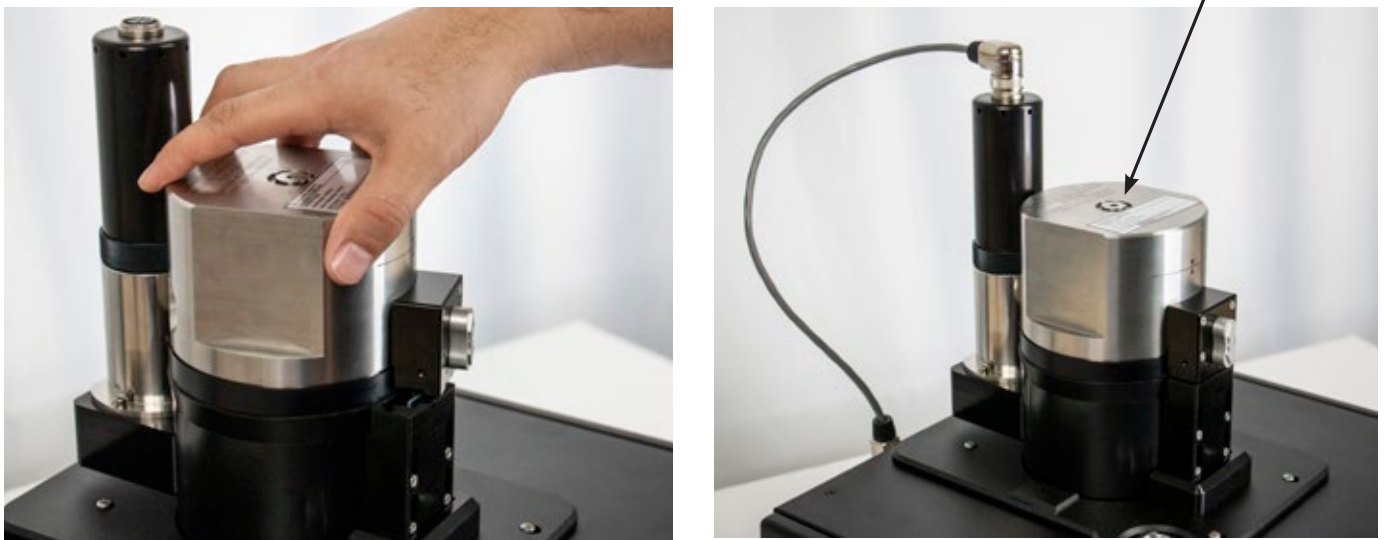

Figure 5.4.2-E Securing the Head

- For CPS8500G measuring heads greater than or equal to 10 bar measuring range (Kn with 1 bar/ Kg or higher), the head needs to be lubricated with oil. Using a syringe, add lubrication oil to the head by unscrewing the 7/16"-20 SAE plug on top of the CPS8500G (Figure 5.4.2-F). The level of the sebacate/drosera oil needs to meet the requirements below. For normal operation and lubrication of the piston inside the measuring head, it is recommend that the oil is visible from the top port.

Oil filling requirements

Range	Oil Type	Qty
▶ 10 bar	Drosera	1.0 cc
▶ 20 bar	Drosera	1.8 cc
▶ 50 bar	Sebacate	2.2 cc
▶ 100 bar	Sebacate	2.4 cc
▶ 200 bar	Sebacate	2.5 cc
▶ 500 bar	Sebacate	2.5 cc

5. Installation

EN



Figure 5.4.2-F Adding Oil to the Gauge Head



The piston lubrication oil recommended for measuring heads with Kn 1 or 2 bar/ Kg is Drosera. Sebacate oil must be used for measuring heads with higher Kn. Oil lubricated heads are prefilled upon delivery.

- The Legacy gauge heads must be mounted diagonally to prevent the base motor from interfering with the head motor. To align the Legacy head, carefully line up the bayonet holes from the base to the head and gently press down and turn clockwise until secure.
- For Legacy measuring heads greater than or equal to 10 bar measuring range (Kn with 1bar/Kg or higher), the head needs to be lubricated with oil. Using a syringe, add lubrication oil (Drosera or Sebacate) to the head by unscrewing one of the hex screws on top of the measuring head. The head will be labeled with the type of oil that should be used. The level of the oil needs to be measured from the sightglass on the front of the head. For normal operation and lubrication of the piston inside the measuring head, it is recommended that the oil level be half of the oil column (Figure 5.4.2-H).

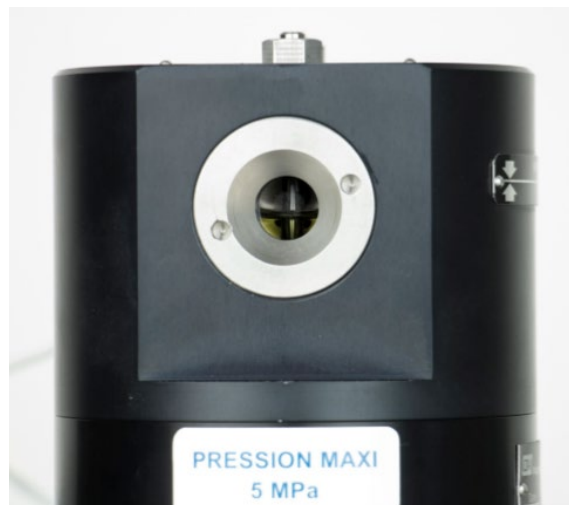

Figure 5.4.2-H Sightglass

PN 0019408001G 06/2022 EN

5. Installation

5.5 Head Temperature Probe Installation

The head temperature probe is installed on the measuring head to ensure stable head temperature during operation along with temperature variation feedback to the base for accurate pressure calculation. Simply insert the head temperature probe into the probe slot placed on one side of the measuring head. Figure 5.6-B shows the probe connected to the head. The electrical connection for the probe is done by the rear panel of the CPD8500. See Section 5.7 Rear Panel for more details.

EN

5. Installation

5.6 Motor Installation

The drive motor is installed on the base of the CPD8500. Some of the legacy heads may come with a motor attached to the head, in this case, the base motor will not be used.

Motor installation can be done either before or after head installation. The motor assembly and motor power cable is part of the packaging for the CPD8500 (Figure 5.6-A). Simply insert and screw in the bottom end of the motor to the matching cover or motor adapter on the base (Figure 5.6-B).

EN



Figure 5.6-A Brushless motor and Cable

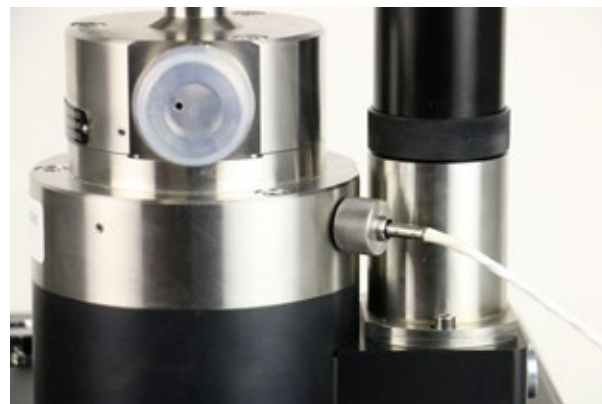
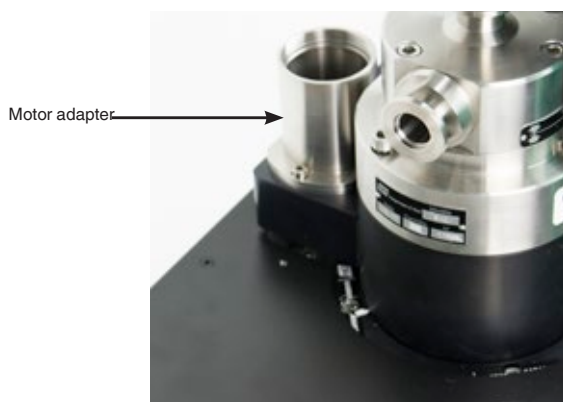

Figure 5.6-B Motor installation

5.7 Process Connections

5.7.1 Onboard Memory

The CPS8500A and CPS8500G head versions are equipped with onboard flash memory that stores the head data file. This file provides the serial number, linearity information, range information and all other values needed by the CPD8500, found in Section 8.2.8.1. This memory can be used by engaging the switch downward to the base as seen on the front of Figure 5.7.1. A green light will appear when the CPS500A is properly connected to the CPD8500 and the instrument software will begin to transfer the head data file. The head memory switch may be engaged before instrument boot up.

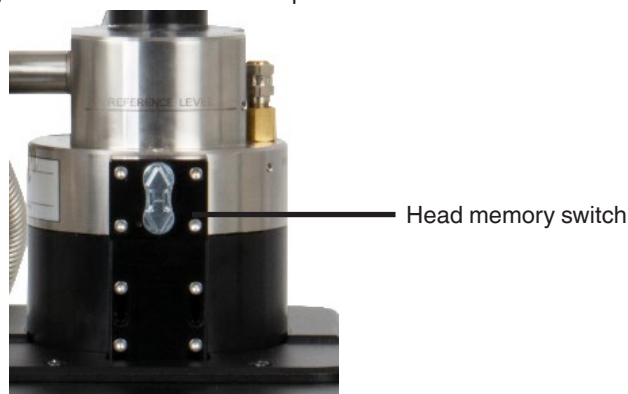

Figure 5.7.1 Onboard memory

5. Installation

EN

5.7.2 CPS8500A Low Pressure Absolute Heads

These instructions are to be followed when installing and setting up 2 and 5 bar CPS8500A absolute heads on an absolute base. Figure 5.7.2 displays the pressure connections required to set up and operate the low pressure CPS8500A with a CPD8500 absolute base. All the valves and tubing involved in the setup process are part of the absolute CPD8500 accessory kit. The following is a list of the accessories needed.

- One flex DN16 vacuum tube
- Six DN16 clamps
- Two DN16 valves
- Three DN16 sintered filters
- Three DN16 seals
- One 0.01 micron filter and adapter
- One test port valve with 1/4" tube adapter
- One T-fitting
- One 7/16"-20 SAE adapter

Connect the DN16 T-fitting to the DN16 pressure port on the CPS8500A and a DN16 sintered seal. Connect one side of the T-fitting using DN16 clamps to the measuring head vacuum isolation valve (3) followed by the filter (4). Connect the vacuum isolation valve (2) to the other side of the T-fitting using the clamps. Secure a vacuum tube with the clamp on the vacuum isolation valve. Clamp the open end of the vacuum tube to the rear panel pressure reference port of the instrument with DN16 sintered filter. See Figure 5.7-B for rear panel connections. Connect the device under test isolation valve (1) using a 1/4" tube fitting or adapter. The DUT must be connected to this port. The vacuum reference supply is required for zeroing and absolute mode operation of the instrument. A vacuum pump must be connected to the open pressure reference port with DN16 sintered filter present in the rear panel (Figure 5.7). If the vacuum pump is not connected to the open pressure reference port, the instrument would work in gauge mode. Additional filtering is recommended for connection to the pressure source and DUT.

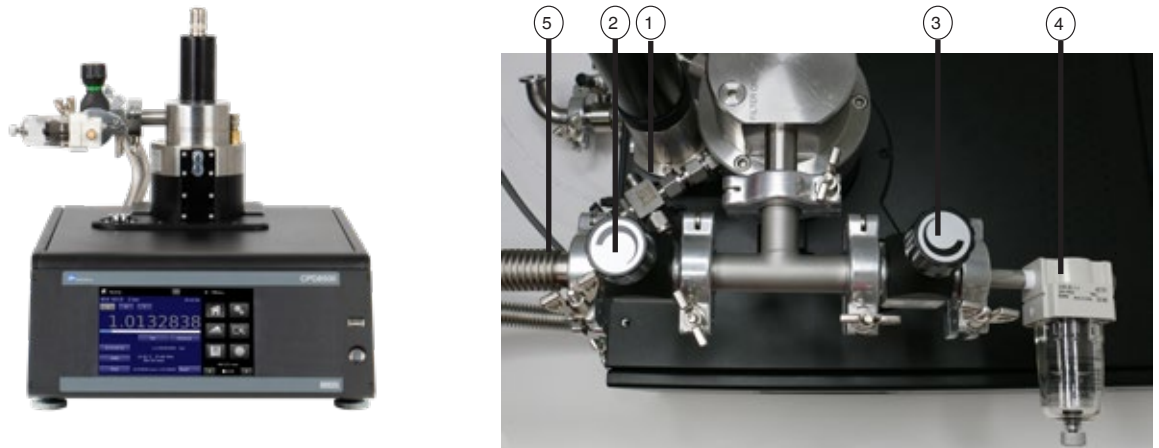

Figure 5.7.2 Front view and top view

- | | |
|---|--|
| ① Device under test isolation valve | ④ Sub micron filter |
| ② Reference vacuum isolation valve | ⑤ Connection to rear panel vacuum reference port |
| ③ Measuring head vacuum isolation valve | |



The isolation valves need to be opened and closed for specific operation purposes. The direction of rotation of each valve must be observed physically on each valve.

5.7.3 Legacy 610 Low Pressure Absolute Heads

These instructions are to be followed when installing and setting up low pressure legacy absolute heads on an absolute base. These instructions are valid for the following measuring heads:

5. Installation

EN

Legacy Measuring Head (Model 610)

Pressure range	Resolution	Kn
0 ... 2 bar (0 ... 72.5 psi)	0.2 Pa	0.2 bar/ kg
0 ... 5 bar (0 ... 145 psi)	0.5 Pa	0.5 bar/ kg

Figure 5.7.3 displays the pressure connections required to setup and operate the low pressure absolute CPD8500. All the valves and tubing involved in the setup process are part of the absolute CPD8500 accessory kit. The following is a list of the accessories needed:

- One flex DN16 vacuum tubes
- Three DN16 valves
- Seven DN16 clamps
- 0.01 micron filter and adapter
- Vacuum pump
- DN16 to 7/16" SAE female adapter

Remove the cover from the pressure ports on the side of the measuring head. Connect one side of the pressure ports using DN16 clamps to the measuring head vacuum isolation valve (3) followed by the filter (4)

Connect the vacuum isolation valve (2) to the other side of the measuring head using the clamps. Secure a vacuum tube with the clamp on the vacuum isolation valve. Clamp the open end of the vacuum tube to the rear panel pressure reference port of the instrument. See Figure 5.8-B for rear panel connections. Connect the device under test isolation valve (1) to the top pressure port of the measuring head using another DN16 clamp. The DUT must be connected to this port. The vacuum reference supply is required for zeroing and absolute mode operation of the instrument. A vacuum pump must be connected to the open pressure reference port present in the rear panel (Figure 5.8-B). If the vacuum pump is not connected to the open pressure reference port, the instrument would work in gauge mode.



The isolation valves need to be opened and closed for specific operation purposes. The direction of rotation of each valve must be observed physically on each valve.



Figure 5.7.3 Low Pressure Absolute Pressure Connections

5. Installation

- | | |
|---|--|
| ① Device under test isolation valve | ④ Sub micron filter |
| ② Reference vacuum isolation valve | ⑤ Connection to rear panel vacuum reference port |
| ③ Measuring head vacuum isolation valve | |



When opening any vacuum valve, especially between vacuum and atmospheric or positive pressure, be careful to open the valve slowly to gradually allow pressure to equalize.

5.7.4 Low Pressure Zero Setup

The CPD8500 rear panel requires the reference port to be installed to a vacuum pump that meets the required specifications from section 11.4. Connect the bleed valve that is supplied with the CPD8500 absolute accessory kit in line with the vacuum pump seen in Figure 5.7.4.



Figure 5.7.4 CPD8500 Absolute Rear Panel Connections

5.7.4.1 Zeroing & Spanning Setup

The following pressure connections (Figure 5.7.1 and 5.7.3) are required before performing a zero or span (single point calibration) for the internal load cell.

- All isolation valves must be closed.
- Start the vacuum pump and evacuate reference chamber until the residual pressure begins to indicate pressure change.
- Open the vacuum valve to the head and allow complete system to pump to desired zero point. The target vacuum should be stable between 2 and 20 Pa.
- Once the system is zeroed, close the vacuum valve and the valve to the coalescing filter to vent the head to atmosphere.
- Once atmospheric pressure is reached, close valve to coalescing filter and open DUT connection.
- Follow the instructions mentioned in Section 6.4.1.3 Zero & Section 6.4.1.4 Span to perform the Zero and Span calibration.

5.7.4.2 Operational Setup

The following pressure connections (Figure 5.7.2 and 5.7.3) are required for general operation of the instrument:

- Reference vacuum isolation valve ② must be closed to keep the vacuum in the reference chamber.
- Isolation valves ③ must be opened slowly to go to atmosphere. The filter ④ will avoid dust or particulate to come inside CPD8500 during this process.
- Valve ① must be opened.
- Valve ③ must be closed.
- The device under test should be connected to the valve ① by the DN16 to 7/16" SAE female adapter or 1/4" tube adapter.

5.7.5 CPS8500A High Pressure Absolute Heads

These instructions are to be followed when installing and setting up 10 and 20 bar CPS8500A absolute heads on an absolute base. Figure 5.7.5 displays the pressure connections required to setup and operate the high pressure absolute CPS8500A with a CPD8500 absolute base. All the valves and tubing involved in the setup process are part of the absolute CPD8500 accessory kit. This configuration uses all the same accessories as the CPS8500A low pressure absolute head, with the addition of an adapter to mount the DN16 port to 1/4" tube.

5. Installation

EN



Figure 5.7.5 Top View CPS8500A High Pressure



CAUTION!

The DN16 connections are rated for up to 5 bar. Anytime pressure above 5 bar is applied, the DUT isolation valve should be closed off to the DN16 fittings.

5.7.6 Legacy High Pressure Absolute Heads

These instructions are to be followed when installing and setting up Legacy high pressure absolute heads on an absolute base. These instructions are valid for the following measuring heads:

CPS8500 Measuring Head (Model 610)

Pressure range	Resolution	Kn
0 ... 10 bar (0 ... 145 psi)	1 Pa	1 bar/ kg
0 ... 20 bar (0 ... 290 psi)	2 Pa	2 bar/ kg

Figure 5.6.6 displays the pressure connections required to setup and zero the Legacy high pressure absolute CPD8500. All the valves and tubing involved in the setup process are part of the low pressure absolute CPD8500 accessory kit. Following is a list of the accessories needed:

- One flex DN16 vacuum tubes
- One DN16 valve
- T-fitting DN16 clamps
- DN16 to 7/16" SAE female adapter

The device under test connects to the measuring head from the top using a t-fitting clamp. Clamp one end of the vacuum tube to the vacuum isolation valve and connect it to the rear panel pressure reference port of the instrument with one more clamp. For performing a zero or span (Section 6.4.1.4 Span), the device under test is disconnected and the other end of the vacuum tube is connected to the t-fitting clamp (Figure 5.7.6).

The vacuum reference supply is required for zeroing and absolute mode operation of the instrument. A vacuum pump must be connected to the open pressure reference port present in the rear panel (Figure 5.8-B).

5. Installation

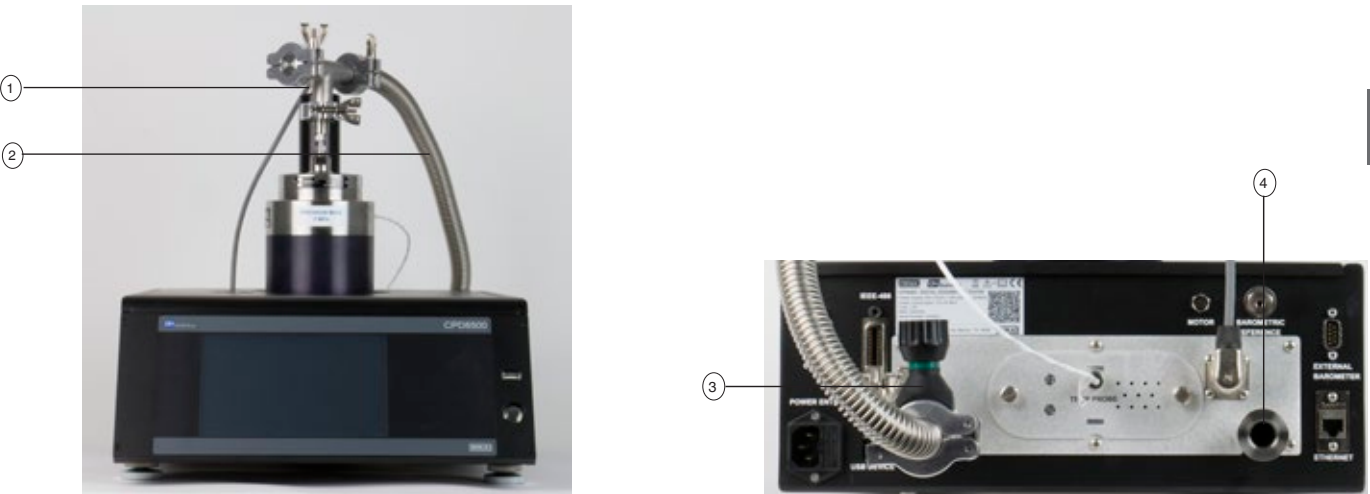

Figure 5.7.6 High Pressure Absolute Pressure Connections

- ① T-fitting DN16 clamp
- ② Connection to rear panel vacuum reference port
- ③ Reference vacuum isolation valve
- ④ Connection to the vacuum pump

5.7.6.1 Zeroing & Spanning Setup

Follow the same instructions from 5.7.4.1 for Zeroing and Spanning the high pressure absolute heads. Be sure to always evacuate each port separately, as evacuating them simultaneously could damage the piston. Always vent the pressure to atmosphere through the coalescing filter.

5.7.6.2 Operational Setup

The following pressure connections are required for general operation of the instrument:

- Reference vacuum isolation valve ③ must be closed to keep the vacuum in the reference chamber.
- Physically disconnect the flex vacuum tube ② on the top of the measuring head by opening the clamps and replace it with the device under test using the DN16 to 7/16" SAE female adapter.

5.7.7 Gauge Heads

These instructions are to be followed when installing and setting up gauge pressure heads. These instructions are valid for the following measuring heads.

Legacy Measuring Head (Model 110/111)		
Pressure range	Resolution	Kn
0 ... 1 bar (0 ... 14.5 psi)	0.1 Pa	0.1 bar/ kg
0 ... 2 bar (0 ... 29 psi)	0.2 Pa	0.2 bar/ kg
0 ... 5 bar (0 ... 72.5 psi)	0.5 Pa	0.5 bar/ kg
Legacy Measuring Head (Model 410)		
0 ... 10 bar (0 ... 145 psi)	1 Pa	1 bar/ kg
0 ... 20 bar (0 ... 290 psi)	2 Pa	2 bar/ kg
0 ... 50 bar (0 ... 725 psi)	5 Pa	5 bar/ kg
0 ... 100 bar (0 ... 1,450 psi)	10 Pa	10 bar/ kg
0 ... 200 bar (0 ... 2,900 psi)	20 Pa	20 bar/ kg
0 ... 500 bar (0 ... 7,252 psi)	50 Pa	50 bar/ kg
CPS8500G Measuring Head		
0 ... 500 bar(0 ... 7,252 psi)	50 Pa	50 bar/kg

5. Installation

The gauge pressure head has a simple device under test connection at the top of the measuring head (Figure 5.7.7-B). The device under test can be mounted directly with the 7/16"-20 SAE to 1/4" tube adapter to the head. For legacy heads (Figure 5.7.7-A), keep the other hex screw closed during measurements. Alternatively this connection can be used for pressure supply.

EN

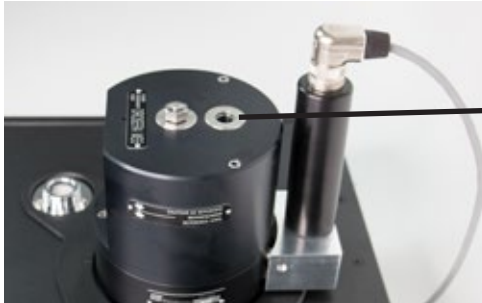

Fig. 5.7.7-A Legacy Gauge Head

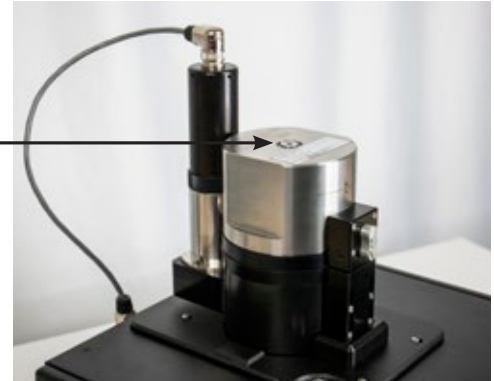

Fig. 5.7.7-B CPS8500G Gauge Head

5.7.7.1 Zeroing & Spanning Setup

With the setup described above, follow the instructions in Section 6.4.1.3 Zero Calibration & Section 6.4.1.4 Span Calibration to perform an adjustment for the zero and span respectively before pressurizing the CPD8500.

5.7.7.2 Operational Setup

Following a successful Zero and Span calibration the CPD8500 is ready to perform device under test measurements. No change in setup is required for this process. The device under test can be pressurized at this time to the desired pressure within the range of the active measurement head.

5.7.8 Switching Measuring Heads

CPS8500 measuring heads are designed to be easily removed and attached to the CPD8500 Digital Deadweight Tester base. This modularity allows for a wide range of calibrations with a single CPD8500. When a head is removed from the CPD8500, the instrument will need to be rebooted. With the CPD8500 OFF, install the new CPS8500 or legacy version measuring head. Once this head is installed to the base, reboot the instrument. This process is critical for accurate calibrations from head to head.

5.8 Head to Base Adaptation

The CPD8500 absolute and gauge bases can both be adapted to either pressure type of CPS8500. The CPD8500 gauge base is supplied with an adapter that is required for mounting both absolute and gauge measuring heads. The CPD8500 absolute base must have an additional adapter in order to use the CPS8500G gauge head. This adapter can be purchased as an accessory with the base or measuring head.

5.8.1 CPS8500A to Gauge Base

In order to mount a CPS8500A absolute measuring head to a CPD8500 gauge base, follow the steps below:

1. With no measuring head installed, remove the circular shield and push rod, shown below.

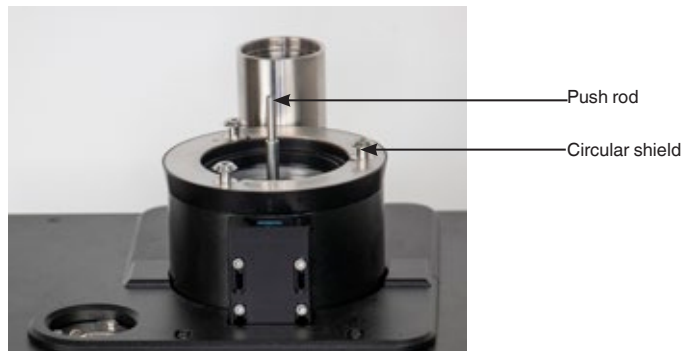

Fig 5.8.1-A Push rod and shield removal

5. Installation

EN

- Use a 3mm hex key to loosen the four screws that hold the electronic adapter board and allow the housing to slide to the bottom. Do not completely remove these 4 screws. They only need to be loosened enough to allow the housing to slide. Once the electronic adapter board housing is lowered, retighten the 4 screws.

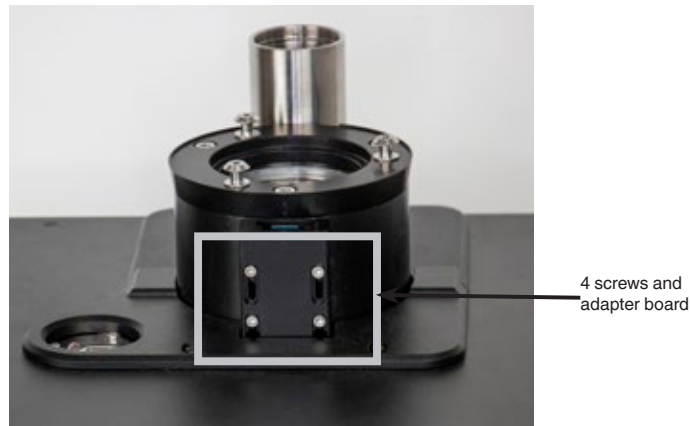

Fig 5.8.1-B Adapter board housing

Using a 5mm hex key, remove the three bolts that mount the gauge adapter plate to the CPD8500 gauge base.

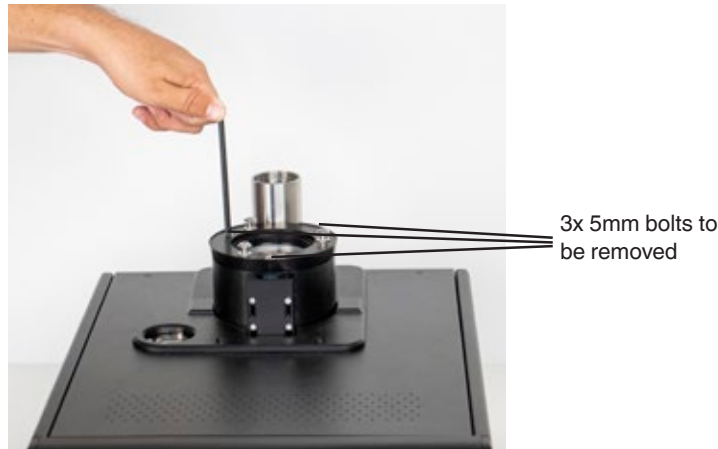

Fig 5.8.1-C Removing gauge adapter plate

- Once the bolts are completely loose, remove the gauge adapter plate. There are 3 O-rings beneath this bracket that will need to remain with the CPD8500 base. Be careful to ensure these O-rings are not stuck to the gauge adapter plate. The adapter board housing should be flush with the new measuring head mounting surface.



Fig 5.8.1-D Check O-rings and housing

4. The base is now ready to mount the CPS8500A absolute measuring head. Install the appropriate push rod from the table in section 5.3 Push Rod Selection. Follow the steps from section 5.4.1 to install the CPS8500A to the base.

EN



Fig 5.8.1-D Mounting CPS8500A

5.8.2 CPS8500G to Absolute Base

In order to mount a CPS8500G gauge measuring head to a CPD8500 absolute base, a gauge adapter accessory is required. Using this adapter, follow the steps below:

1. With the measuring head and motor removed, ensure there are 3 O-rings present on the mating surface of the CPD8500.

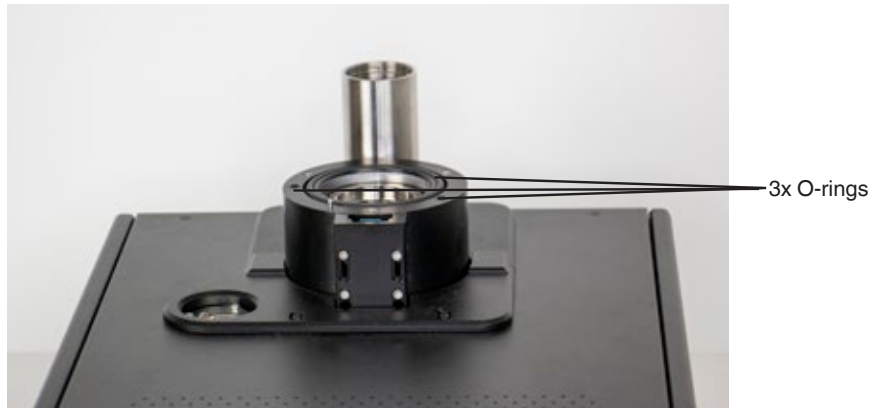

Fig 5.8.2-A Check O-rings

2. Install the gauge adapter with 3x 5mm bolts using a hex key.



Fig 5.8.2-B Install gauge adapter

3. Install the circular shield and the appropriate push rod from section 5.3 Push Rod Selection.

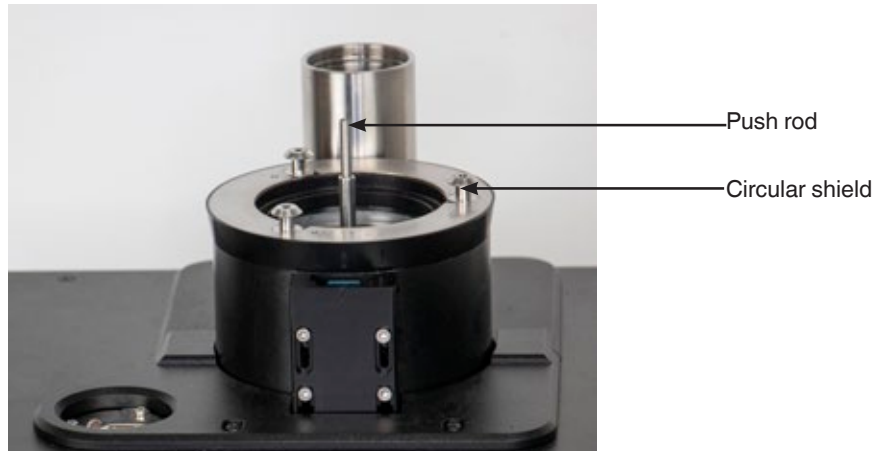

Fig 5.8.2-C Install circular shield and push rod

4. The base is now ready to mount the CPS8500G gauge measuring head. If the measuring head is the legacy version, the adapter board housing can stay mounted in the absolute position, but if the measuring head is the CPS8500G version, the adapter board housing will need to be positioned upward. In order to do this, loosen the 4 screws and slide the housing up to be flush with the new mounting surface. Once in position, tighten the screws to hold the adapter board in place. The image below shows the housing left in the original place because a legacy measuring head is being used.



Fig 5.8.2-D CPD8500 with legacy gauge head

5.9 Rear Panel

The rear panel of the CPD8500 differs slightly between absolute and gauge base types as shown in Figure 5.10-A. Some of the common connections for both types of instruments are the communication ports, power supply, USB host connections, barometric reference port, the brushed DC motor connection and the EMM.

The communication ports for RS-232, IEEE-488 and USB are positioned on the left side while the Ethernet port is located at the bottom right side. In the upper right corner is a M12 fitting, which is connected to the barometric reference sensor if installed, adjacent to that is the connection for brushed DC motor. The USB host connection and the 100-120 VAC power input are located at the bottom left side. The EMM and head temperature probe connections are in the middle of the rear panel. In addition, the both the absolute and gauge bases have connections for brushless DC motor along with two pressure ports for reference vacuum.



Figure 5.10-A Rear Panel - Gauge (left) and Absolute (right)

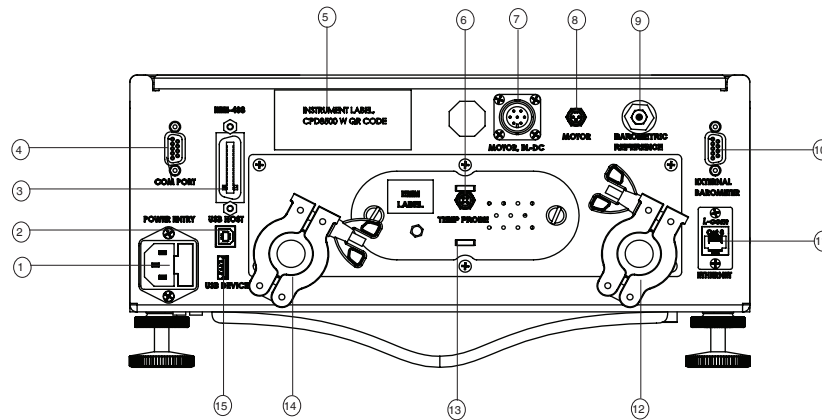

Figure 5.10-B Rear Panel Connections

- | | |
|------------------------------------|--|
| ① Power adapter | ⑧ Brushed motor interface |
| ② USB host | ⑨ Internal barometric reference port |
| ③ IEEE-488 interface | ⑩ External barometric reference interface |
| ④ RS-232 interface | ⑪ Ethernet port |
| ⑤ Product label | ⑫ Vacuum reference pressure port to measurement head (absolute units only) |
| ⑥ Head temperature probe interface | ⑬ EMM |
| ⑦ Brushless DC motor interface | ⑭ Vacuum reference pressure port to vacuum pump (absolute units only) |

5.9.1 Reference Supply Port

These ports are present only in the absolute version of the instrument. The pressure supplied to these pressure connections should be from a vacuum pump external to the instrument. These ports are connected internally in the CPD8500. The vacuum pump must be connected to only one port at a time with the other port connected to the measuring head as explained in Section 5.7.2 CPS8500A Pressure Absolute Heads, 5.7.3 Legacy Low Pressure Absolute Heads, Section 5.7.5 CPS8500A High Pressure Absolute Heads, and Section 5.7.6 Legacy High Pressure Absolute Heads.

5.9.2 Optional: Barometric Reference Port

The Barometric Reference port is connected to the optional internal barometer and should be left open to atmospheric pressure.

5.9.3 Remote Communication Connections

The IEEE-488, Ethernet, RS-232 and USB ports are present in the rear panel of the CPD8500 to provide to connect and communicate with the CPD8500 remotely. Details on setting up each communication mode are explained in Section 6.4.6 Remote Settings Application & Section 7. Remote Operation.

6. Operation

6.1 General Operation

This section describes the procedures for operating the CPD8500 from the front panel. By following the procedures you can expect your CPD8500 to deliver maximum accuracy and dependability for many years of useful service.

6.1.1 Power Up

Apply power to the power connector on the rear of the instrument using the power adapter included, and switch the power switch on the front of the unit ON. The instrument will go through an initialization process and system check. As soon as the system check is completed the system will default to a screen similar to the one shown in Section 6.1.3 Display Screen Features. The main measurement screen may be configured in many different ways but initially it will be in a default configuration. Subsequently, the unit will power up in the configuration that it was in when last powered off.

**WARNING!**

Allow about 4 hours of stabilization time after power is turned on for the first time in a new environment and minimum 15 minutes of warm up for following power cycles. The time since power on can be noted with a reading on the Uptime Clock on Home Screen.

**WARNING!**

Do not position the equipment so that it is difficult to remove the power cord. The instrument is not intended for connection of long-distance lines, i.e. lines within a building that are longer than 30 m, or that leave the building (including lines of outdoor installations).

6.1.2 Setup Applications

Configuration of the CPD8500 is achieved by changing settings accessed through the Application (“App”) buttons. Local operation is accomplished by observing the data presented in the display. The appearance and functionality of the display can be changed by pressing the App button for the related function. After an App has been chosen, a set of related parameters will appear on the left. After choosing one of these parameters, a set of selections related to that parameter will appear on the right or a data entry keypad. The desired selection or data can be entered here.

6.1.3 Display Screen Features

The screen shown below provides an overview of the features that may appear on the display after initialization. The left three fourth of the display contains the area where information is displayed (in this case the Home Application) and the right one fourth contains the selection icons for each application. A tare button, uptime clock, bar graph and up to three of the available auxiliary displays (Uncertainty, Peak, Head Temperature, Ambient Temperature, Ambient Humidity, Ambient Pressure, Residual Pressure, Secondary Units, Mass and EMM) will appear in the Home App if activated. All of the CPD8500 screen features are described in more detail throughout this manual. The active App is represented with a dark to light gradient from the top to bottom compared to the other Apps.

6. Operation

EN

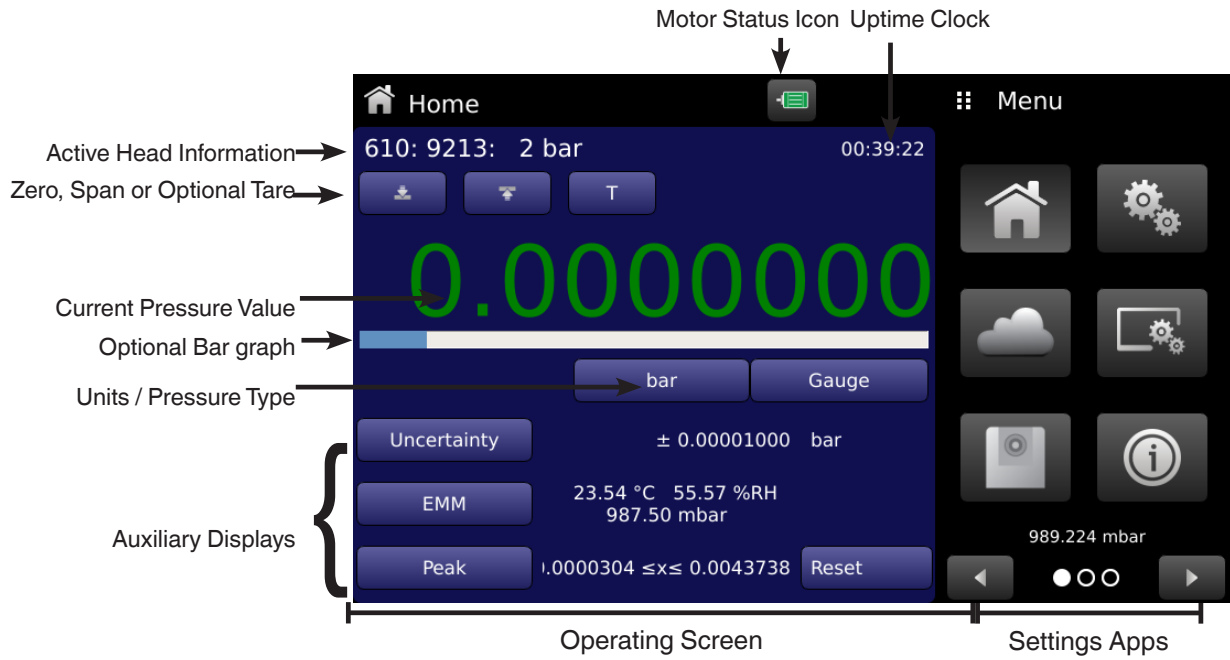



Figure 6.1.2 Display Screen Features

6. Operation

6.2 Initial Setup

Section 6.2.1 Local Gravity Setup and Section 6.2.2 Contact and Version Information Application are provided first so that the operator can initially check the information screen to verify the installed components and to change the language if needed.

6.2.1 Local Gravity Setup

The CPD8500 uses local gravity as part of the internal calculation to deliver an accurate pressure value. Upon power up, the local gravity prompt appears on the right side of the screen (Figure 6.2.1 Local Gravity Setup). The user could setup the local gravity by clicking [] and then navigating to the Service Application (Section 6.4.9 Service Application). Further details on setting local gravity is mentioned in Section 8.2.9 Reference Level.

EN



Figure 6.2.1 Local Gravity Setup

6.2.2 Contact and Version Information Application



Press the Information App button [] to display Mensor contact, active head information, installed environmental monitoring module along with instrument and software version information. Information on optional sensors such as the internal barometer and a vacuum sensor can also be found here.

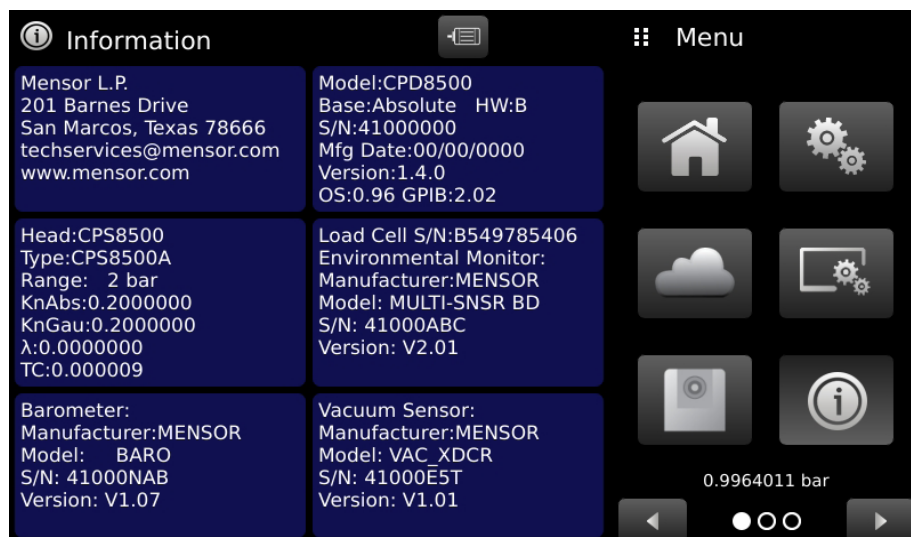

Figure 6.2.2 Information

6. Operation

6.2.3 Language Selection

EN



Pressing the settings application button will open a screen where the language, display brightness, user base units/multiplier and configuration loading/saving, can be changed. The current language selections available are shown in the table below. Additional language choices will appear on the screen after pushing the Next Page button [▶]

:

Language	Country
English	USA
German	Germany
French	France
Spanish	Spain
Italian	Italy
Japanese	Japan
Chinese	China
Korean	Korea
English	Great Britain
English	Canada
French	Canada
Spanish	Latin America
Polish	Poland
Portuguese	Portugal
Portuguese	Brazil
Russian	Russia

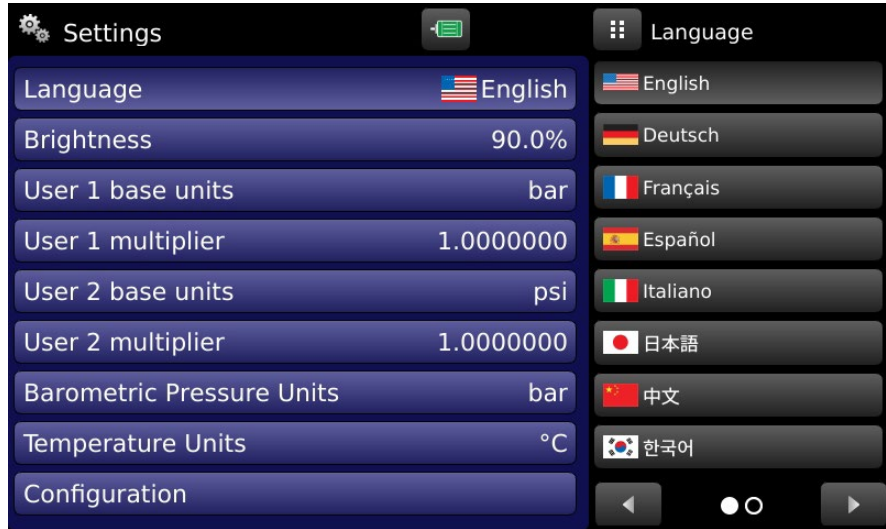

6.2.4 Active Head Selection

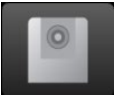

Press the Head Information App button [▶] to display information on the active head. Ensure that the installed head information matches the head information. A pre-saved head can be selected by pressing the Selected Head button. The Selected Head button when pressed displays all the pre-saved heads on the right (Figure 6.2.4-A Head Selection). Before proceeding further, match the Head type, Serial number (S/N) and pressure range as displayed on the actual head (Figure 6.2.4-B Head Label) with the information in the Head Information App.

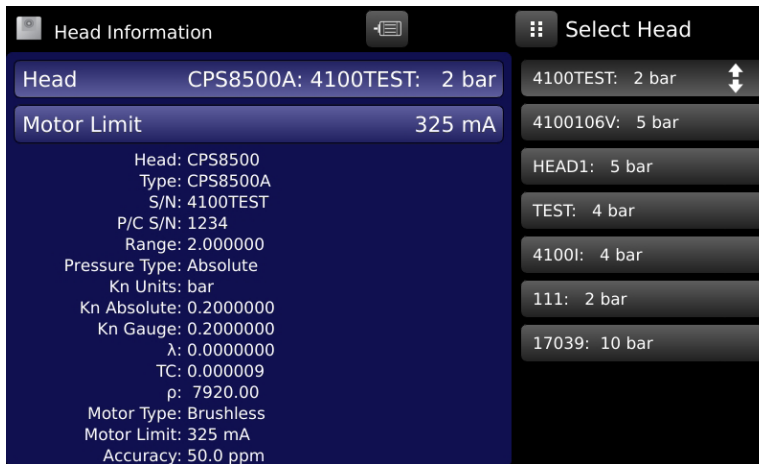

Figure 6.2.4-A Head Selection

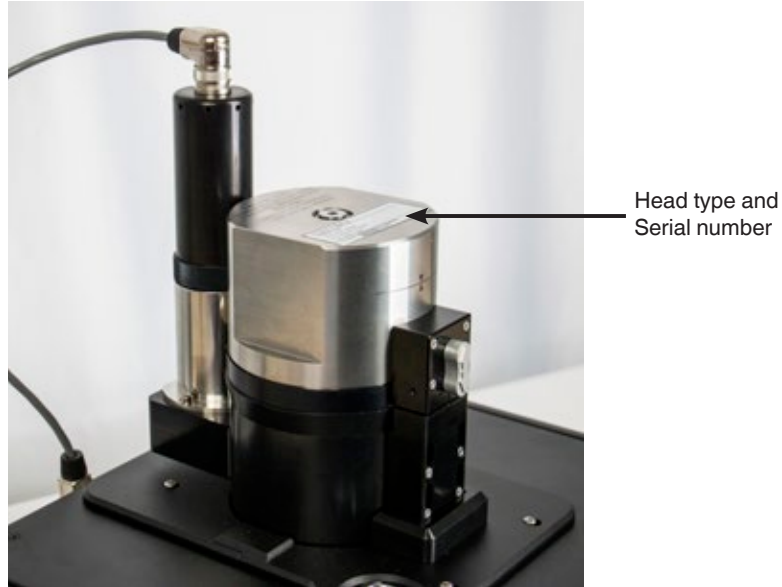

Figure 6.2.4-B Head Label

In the event that the Head Information saved within the CPD8500 doesn't match with the measurement head, connect the USB device provided by Mensor to the front USB port (Figure 6.2.4-C Front USB Port). The CPD8500 recognizes the USB by indicating a USB button [] in top bar of the screen (Figure 6.2.4-D USB Button). The Upgrade menu screen can be accessed by pressing this USB button. Figure 6.2.4-E Upgrade Screen displays the Upgrade menu to upgrade the instrument software and load Head Data from or to the USB drive. Simply press the "USB Drive --> Head Data" button to load the Head information present on the USB drive to the CPD8500. The new head information would be visible in the Head Information App menu along with other pre saved head information. The CPS8500A and CPS8500G have the head information stored to the flash memory. Engage the onboard memory switch to load the head information to the CPD8500 automatically.



Figure 6.2.4-C Front USB Port





Figure 6.2.4-D USB Button



Figure 6.2.4-E Upgrade Screen

6.2.5 Head Motor Activation

The motor status icon appears on the top bar of the screen and is visible to the user in any App. By default the motor icon is black [] in color to indicate that the motor is off and the piston-cylinder inside measuring head is not spinning. The motor can be turned on by clicking the motor icon, this temporarily freezes the icon to indicate the step up process for the motor before changing the color of the motor to green [], indicating an active motor spinning the piston-cylinder. The motor should be turned on while operating and performing calibration functions with the CPD8500.

The motor status icon turns yellow [] to indicate a warning or an error in spinning the piston-cylinder. The details on the error can be noted in the Troubleshooting App.

6. Operation

6.3 Application Selection and Parameter Inputs

The application selection area on the right one fourth of the screen (see Figure 6.1.2 Display Screen Features) is the area where setup, information, calibration, service and other Apps can be chosen. Multiple pages of application selections can be accessed by pressing the Next Page button [▶] or by pressing the Previous Page button [◀]. A series of horizontally placed circles on the bottom right indicate the active page by a larger circle. As each App is chosen, related application parameters will appear on the left three fourth of the screen along with the name of the application, and a reduced size icon in the top title section. When a parameter is chosen, related selections, sliding scales or a data entry key pad will appear in the input area on the right where the application selection buttons were previously displayed. An example of each type of input is shown below. To return to the App selection menu, simply press the Menu button [☰] above the input area. The purpose and use of each selection and menu is intuitively apparent and will become second nature with minimal exposure to the menu structure.

EN

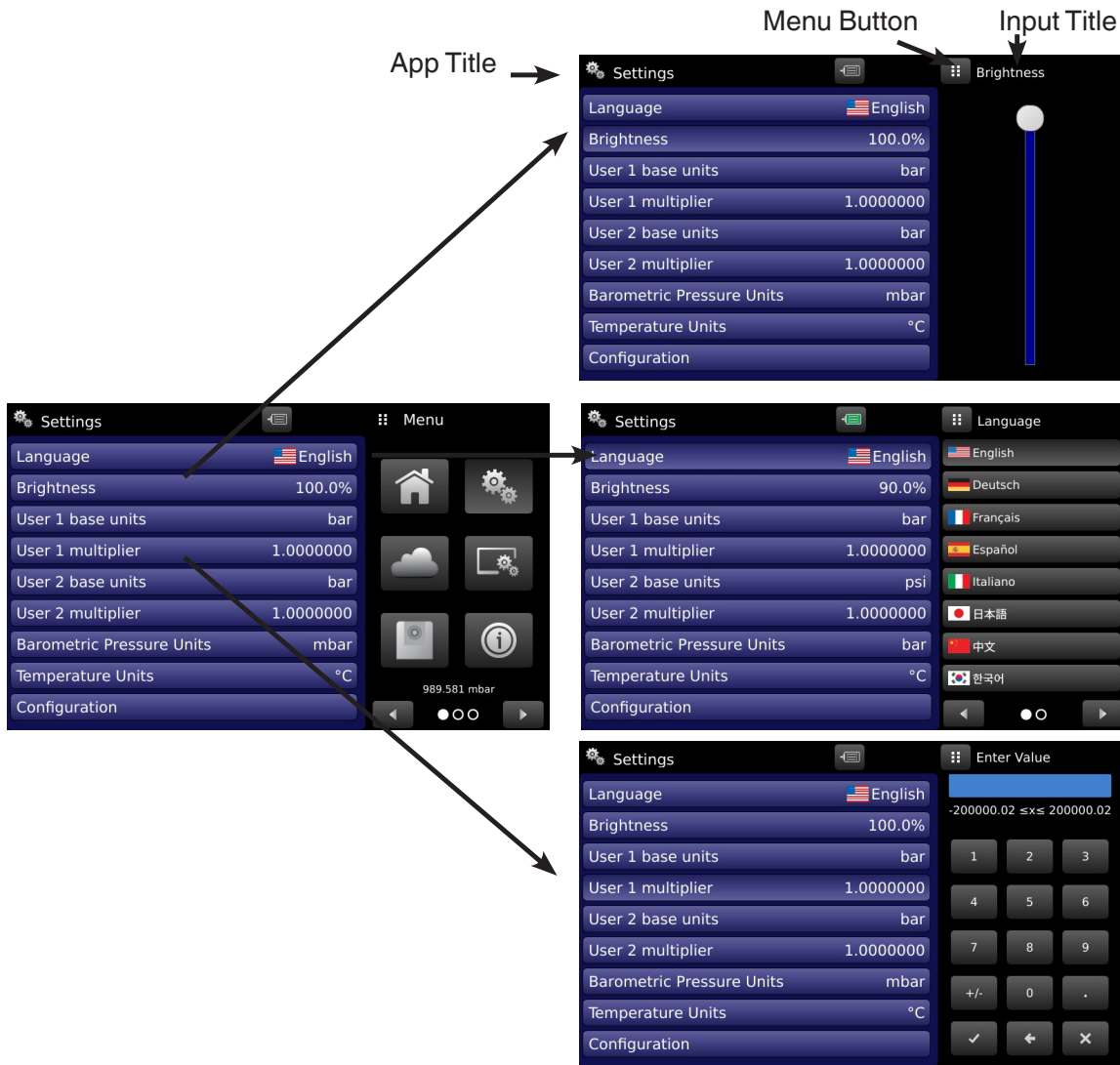

6. Operation

6.4 Applications

6.4.1 Home Applications

EN



The Home App is the normal operation screen. This application is different from the others in that it is not used to setup the configuration but is used to monitor the pressure applied to the current head.

The screen in Figure 6.4.1-A Basic Home App shows the basic Home App in an instrument. The user can change the display to show an uptime clock indicating time since power on, a bar graph corresponding to the range of the head, a Tare button and multiple auxiliary displays by pressing the auxiliary buttons on the left corner of the screen (Figure 6.4.1-B Home App with all Features). The Zero, Span and Units button are always displayed. When the Units button is pressed a selection of imperial and metric units will be displayed on the right (Figure 6.4.1-C Pressure Units). Additional icons representing the status of the instrument may appear adjacent to the Tare button during operation (Table 6.4.1 Internal Status Icons).



Figure 6.4.1-A Basic Home App



Figure 6.4.1-B Home App with all Features





Figure 6.4.1-C Pressure Units

PN 0019408001G 06/2022 EN

6. Operation

Table 6.4.1 Internal Status Icons

Icon	Description
	Pressure reading unstable
	Internal load cell busy
	EMM parameters outside stable window

EN

6.4.1.1 Current Pressure Reading

The current pressure reading is displayed in the Home App at all times. The pressure reading can appear either gray, white or green in color indicating invalid, unstable or stable pressure values respectively (Figure 6.4.1.1-A Invalid Pressure Reading).



Figure 6.4.1.1-A Invalid Pressure Reading



Figure 6.4.1.1-B Unstable Pressure Reading



Figure 6.4.1.1-C Stable Pressure Reading

PN 0019408001G 09/2022 EN

6. Operation

6.4.1.2 Units and Pressure Type

The Units button is always displayed. When the units button is pressed a selection of imperial and metric units will be displayed on the right (Figure 6.4.1.2-A). The units menu is categorized by Imperial and Metric units. Further pressure units of each category can be navigated by the page forward [▶] and backward [◀] keys.

EN

The current pressure type is displayed by the Pressure Type button in the Home App. When an optional internal/ external barometric reference is installed, the native gauge instrument can emulate absolute pressure using the barometric reference. However for a native absolute instrument with an absolute base and an absolute head, the instrument can work in either gauge or absolute mode depending on the rear panel reference port connection. If the pressure reference port is left open to the atmosphere, the instrument measures gauge pressure, alternatively if the reference port is connected to a vacuum pump, the instrument can only measure absolute pressures. Both emulation and native pressure type can be activated simply by pressing the Pressure Type button. The emulation pressure type is highlighted in gold to distinguish from the native mode (Figure 6.4.1.2-B)

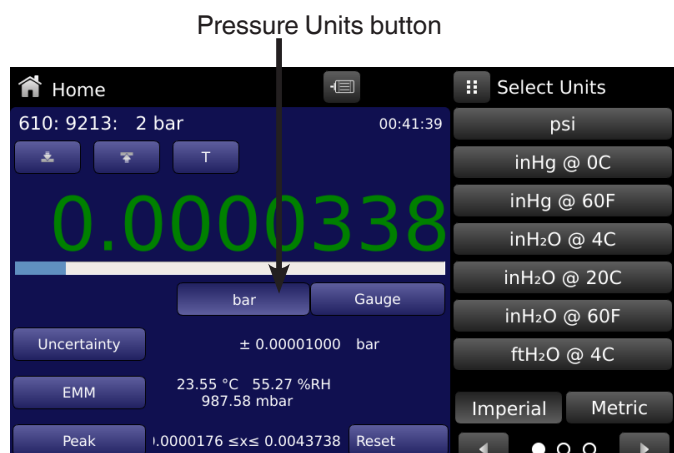

Figure 6.4.1.2-A Pressure units



Figure 6.4.1.2-B Pressure Type (Emulated)

6.4.1.3 Zero

The Zero button [⬇️] in the Home App allows the user to perform a single point calibration to adjust the zero point of the internal load cell of the instrument. The Zero calibration must be performed, if after power up, the user notices a slight drift. This drift can be attributed to a variety of reasons like temperature drifts, changes in ambient conditions, changes in leveling of the instrument and/or its location. Table 6.4.1.4 displays different scenarios requiring Zero and Span calibration.

The procedure for performing the Zero calibration is different for absolute and gauge mode. Figure 6.4.1.3 Zero Button shows the Zero button in the Home App.



Figure 6.4.1.3 Zero Button

6. Operation



WARNING!

In order to obtain accurate pressure measurements, the user must check that the display indicates stable zero, before starting any measurements.

EN

6.4.1.3.1 Zeroing in Gauge Mode or Emulated Gauge Mode

This procedure is valid only when the pressure type of the instrument is set to Gauge. This can be done for following combinations in the instrument:

- A gauge base with a gauge head
- An absolute base with an absolute head with vacuum reference ports open to atmosphere.
- An absolute base with a gauge adapted absolute head

Pressing the Zero button initiates a zeroing sequence as shown by Figure 6.4.1.3.1 Zeroing in Gauge Mode. The current pressure reading turns gray during the process to indicate a non valid pressure reading. The status of the zeroing sequence is displayed on the right side of the screen. During the zeroing sequence, the status icon represents that the load cell is busy.

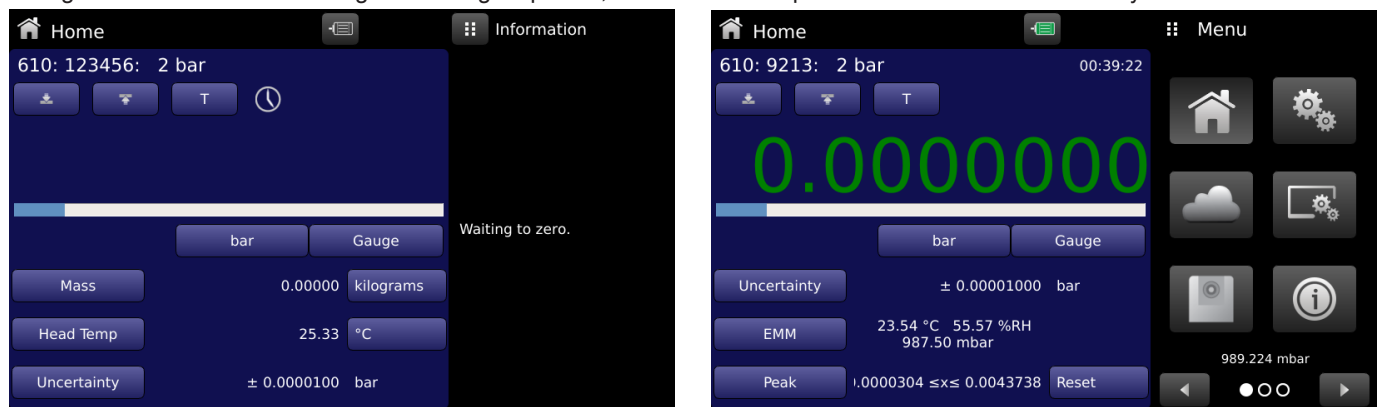

Figure 6.4.1.3.1 Zeroing in Gauge Mode

6.4.1.3.2 Zeroing in Absolute Mode



This procedure is valid only when the pressure type of the instrument is set to Absolute. This can be done when an absolute head is installed on an absolute base and the operation is carried out in native pressure mode. The Zero button is inaccessible (grayed) until a stable vacuum pressure is applied on the reference of the instrument and the vacuum sensor displays a value less than 20 pascals and greater than 2 pascals. Vacuum pump recommendations and connections are mentioned in Section 5. Installation.



Figure 6.4.1.3.2 Inaccessible Zero Button

6. Operation

6.4.1.4 Span

The Span button [] in the Home App allows the user to perform a single point calibration to adjust the span of the internal load cell of the instrument. The span calibration process loads a calibration mass located inside the instrument on the load cell to readjust the span of the cell. Figure 6.4.1.4-B shows the Span button turns orange [] when the Environmental Monitoring Module detects a change in the environment conditions outside the preset tolerance values. In this event, the user must perform the Span calibration by pressing the Span button. The status of the Span sequence can not be interrupted and the status of the process can be seen on the right side of the screen (Figure 6.4.1.4-C). The pressure reading turns gray during this time to indicate an invalid value. Table 6.4.1.4 displays different scenarios requiring Zero and Span calibration.

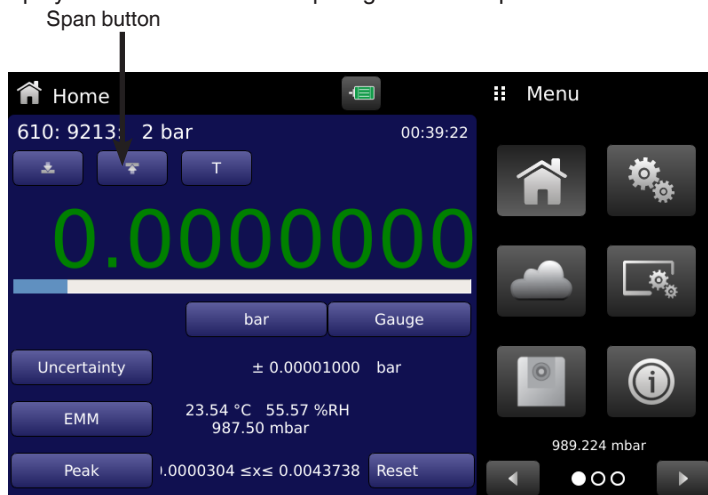

Figure 6.4.1.4-A Span Button



Figure 6.4.1.4-B Span Calibration Required



Figure 6.4.1.4-C Span Calibration Process



WARNING!

If there is a change in ambient conditions recorded by the Environmental Monitoring Module during the Span calibration process or unstable pressure due to vibrations and supply changes, the Span calibration is unsuccessful and an error is reported



WARNING!

It is recommended to do a span calibration each time the instrument is powered up.

6. Operation

n	Condition	Scenario
1	Upon first boot up	May be done at any point; must be done after the initial warm-up period
2	New head selected	Selecting a new head data file
3	Pressure type changed	Changing from gauge, absolute, bidirectional modes; especially when the pressure applied to the reference port is changed
4	Head Temperature Probe out of tolerance	Tolerance limits settable in Limits application
5	Ambient Pressure out of tolerance	Tolerance limits settable in Limits application
6	Ambient Temperature out of tolerance	Tolerance limits settable in Limits application
7	Relative humidity out of tolerance	Tolerance limits settable in Limits application

EN

6. Operation

6.4.1.5 sBar Graph

An optional bar graph can be displayed below the current pressure value. The bar graph indicates the relative position of the current value within the maximum range of the active head. This bar graph will appear in the Home App when selected from the Display Settings App (Section 6.4.4).

EN

6.4.1.6 Auxiliary Displays

The screen in Figure 6.4.1.6-A shows all of the possible auxiliary display items that can be included in the Home App. The instrument can have up to three auxiliary displays which can be chosen by clicking on each button and then selecting the display item from the menu on the right side of the screen (Figure 6.4.1.6-B). All the auxiliary display items can be navigated using the page forward [▶] and backward [◀] keys at the bottom of the right side of screen.



Figure 6.4.1.6-A Home App with Auxiliary Displays



Figure 6.4.1.6-B Auxiliary Display Selection

Some of the auxiliary display can be modified by pressing the displayed button. Others simply display auxiliary information.

- **Peak:** Pressing the Peak button will reset the upper and lower peak value to the current reading, subsequent negative or positive divergence from that reading will be recorded in the button.
- **Secondary Units:** Pressing the Auxiliary Units button will display the same set of units available for the primary units. Pressing any of these units will change the auxiliary units to that chosen unit.
- **Head Temperature:** Displays the current temperature of the active head. The temperature unit can be changed by pressing the displayed unit to degree Celsius, Fahrenheit or Kelvin.
- **Ambient Temperature:** Displays the current atmospheric temperature recorded by Environmental Monitoring Module (EMM). The temperature unit can be changed by pressing the displayed unit to degree Celsius, Fahrenheit or Kelvin.
- **Ambient Humidity:** Displays the current ambient humidity recorded by Environmental Monitoring Module (EMM). The humidity is displayed as a "% RH" value.
- **Ambient Pressure:** Displays the current atmospheric pressure recorded by Environmental Monitoring Module (EMM). The pressure unit can be changed by pressing the displayed unit to either an Imperial or Metric unit.
- **Residual Pressure:** Displays the vacuum pressure detected by the internal vacuum sensor. Pressing the residual pressure units allows a selection of Imperial or Metric units.
- **Uncertainty:** Displays the accuracy at the pressure being displayed.
- **Mass:** Displays the value of the current effective mass on the internal load cell.
- **EMM:** Displays the combined values of ambient conditions measured by the Environmental Monitoring Module.

6.4.1.7 Uptime Clock

The uptime clock present on the top right corner of the display screen represents the time passed since power up. This clock is provided to assist in determining the setup and stabilization time during installation (Section 5.7.4).

6. Operation

6.4.1.8 Tare Button

If the Tare calibration function has been chosen in the Display Settings App (Section 6.4.4), then the Tare Button [] will appear in the Home screen. For safety reasons, the tare button will be highlighted in golden when active. When the Tare button is pressed, the instrument will subtract the current pressure reading (the tare pressure) so that the instrument will display zero. Subsequent deviations in pressure will be relative to the tare pressure.

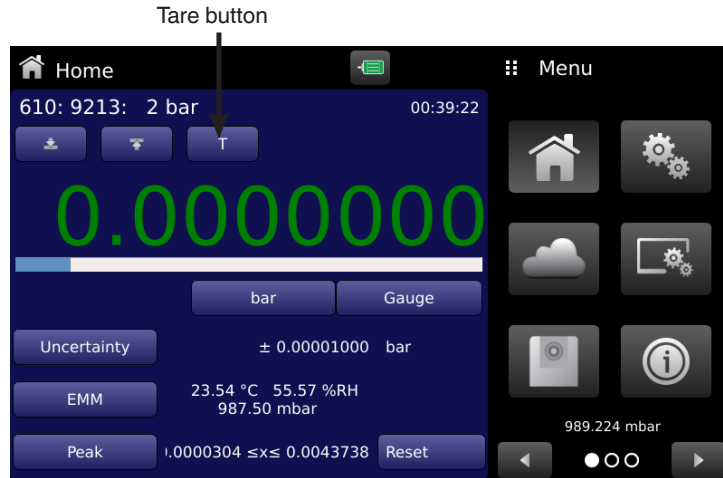

Figure 6.4.1.8 Tare Button

Pressing the tare button again will deactivate the tare and change the pressure indication back to the reading corresponding to the calibrated output of the transducer. An active tare will revert to a deactivated state after a power cycle.

6.4.1.9 Active Head

The Home App displays basic information on the current head in the top left of the screen. This includes the Head Type, Serial Number and Pressure Range in native units. The active head can be selected in Section 6.4.5 Head Information Application.

6.4.1.10 Barometer

If an external or internal barometer is installed, the atmospheric pressure sensed by the barometer is displayed on the bottom right of the screen (Figure 6.4.1.10). The barometer units can be selected in the Section 6.4.2.4 Barometer Units.



Figure 6.4.1.10 Barometer Readout



When both the internal and external barometers are connected to the instrument. The Barometer Readout would indicate the external barometer and would utilize this to do emulated pressure measurement.

6. Operation

6.4.2 Settings Application

EN



The Settings App is used to set up general settings for the display. Settings parameters include Language, Brightness, User 1 base units, User 1 multiplier, User 2 base units, User 2 multiplier, Barometer units, and Configuration. Figure 6.4.2 Settings App shows these parameters as indicated, when the Settings App has been chosen. As each parameter is pressed, an input screen will appear on the right where selections can be made.

The Settings App provides a place to change the language, display brightness, user units, and barometer units. Configuration settings of the instrument can also be saved within this application plus the default configuration can be activated.

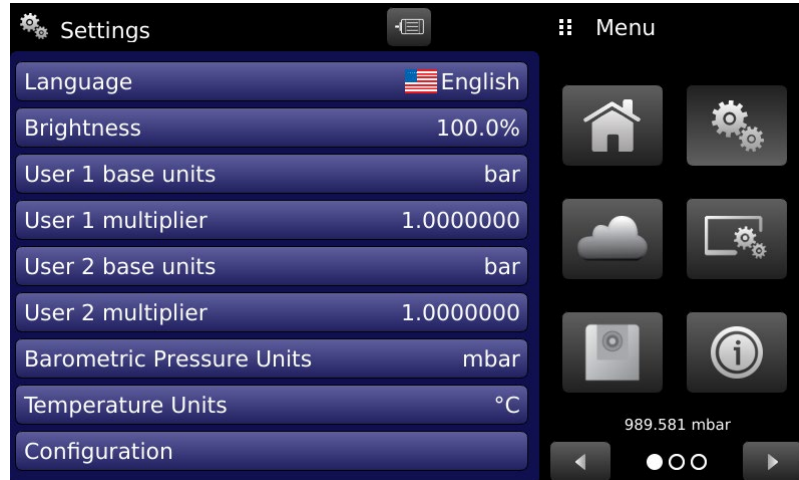

Figure 6.4.2 Settings App

6.4.2.1 Languages

The Language parameter provides a selection of different languages. Once a language is chosen all words within all menus will appear in the chosen language and the radix character (decimal mark) will change from a dot (.) to a comma (,) depending on the language chosen. More languages can be accessed by navigating to the next page of the language selection menu on the right side of the screen.



Figure 6.4.2.1 Languages

6. Operation

6.4.2.2 Brightness

The Brightness setting provides a sliding scale to increment the screen brightness in all screens. Sliding your finger along the bar/line to move the ball cursor or touching anywhere on the bar/line will change the brightness of the screen. After the setting is made and your finger is removed from the screen the menu will show the brightness percent selected.

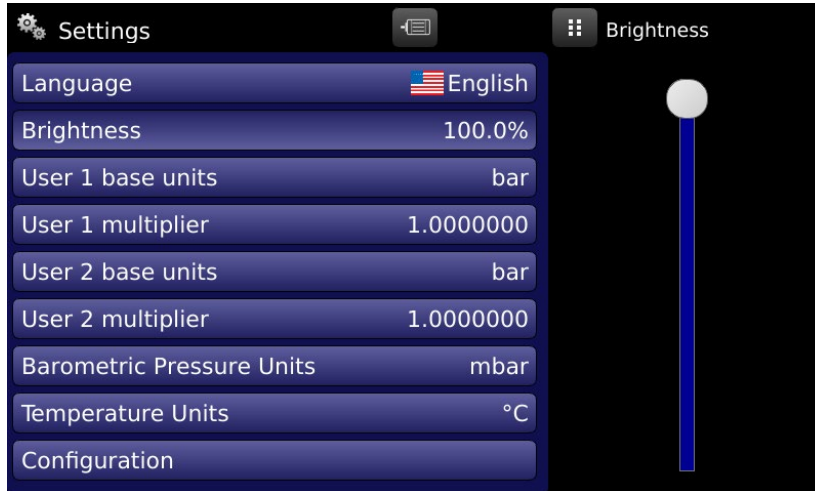

Figure 6.4.2.2 Brightness

6.4.2.3 User Base Units/ Base Units Multiplier

When choosing a unit of measure from the Home Application (main screen), standard units can be chosen in addition to two user defined units. User units 1 and 2 are defined in the Settings App using “User 1 base units”, “User 1 multiplier” and / or “User 2 base units”, “User 2 multiplier”. If the display of a special unit is needed, then a base unit should be chosen (psi, bar or Pascal) as the “User base unit” and the “User multiplier” can be entered to derive the special unit using the formula: Special unit = Base Unit x Unit multiplier. When set this way, and the user unit has been chosen from the main screen, then the user unit will now display the Special unit as derived.

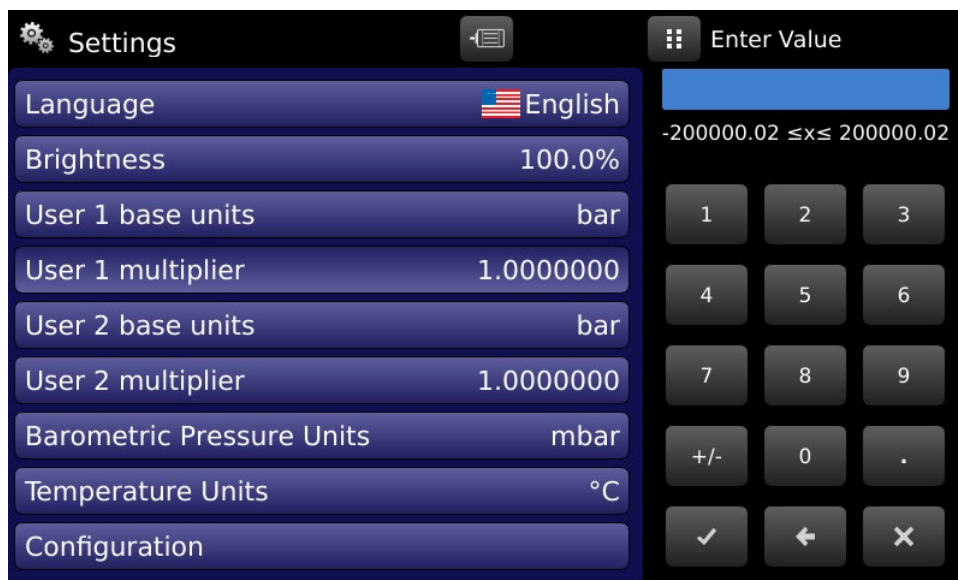

Figure 6.4.2.3 User base units/ Base units multiplier

6. Operation

6.4.2.4 Barometer Units

When the Barometer Units button has been chosen, a list of Imperial or Metric units is presented on the right side of the screen. Any of these units can be chosen from this list for the barometric readout. The barometric pressure readout can be seen on the bottom right of the Home App. These units are applicable to both the internal or external barometer.

EN



Figure 6.4.2.4 Barometer units

6.4.2.5 Configuration

Configuration is the last parameter in the Settings App. It allows the operator to save instrument settings and load them as a group, as needed, in the future. Configuration variables that are currently set in all Apps can be saved using the Configuration "Save" button and recalled using the Configuration "Load" button. Simply set all desired variables in each App, then go to Settings-Configuration, press one of the numbered Configuration buttons then press the "Save" button. This will save the current configuration in that button. To reload a saved configuration at a later time, go to Settings-Configuration and press the numbered configuration button corresponding to the saved configuration and then press the "Load" button.

The instrument default configuration can be activated simply by pressing the "Default" Button.

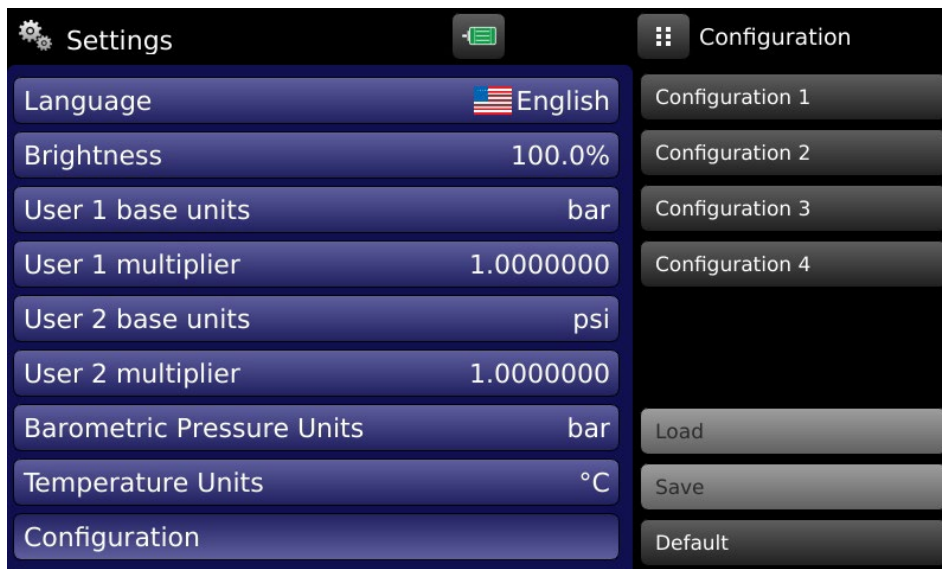

Figure 6.4.2.6 Configuration

6. Operation

6.4.3 Limits Application



The Limits App allows the user to select and configure the tolerance limits for ambient conditions, head temperature and stability parameters for pressure and vacuum reading. Figure 6.4.3 Limits App shows the Limits Application screen.

EN

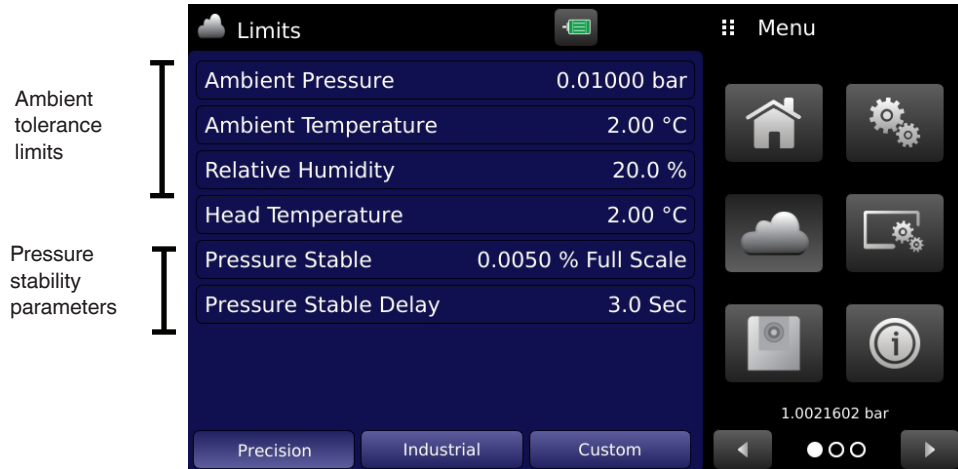

Figure 6.4.3 Limits App

6.4.3.1 Ambient Tolerance Limits

The ambient pressure, temperature and relative humidity limit buttons in the Limits App provide a place to set the ambient limits. These tolerance limits determine the acceptable variation in ambient conditions for which the internal load cell measurement is considered stable. There are preset tolerances for Precision and Industrial modes and by default the instrument has the Precision mode selected. These limits can be adjusted to custom values in Custom mode. In Custom mode, pressing any of the ambient tolerance limits, opens a data entry keypad to enter the new limit in the current pressure or temperature units. This will save the new limits as custom limits. Figure 6.4.3.1 Ambient Tolerance limit shows the Custom mode.



Figure 6.4.3.1 Ambient Tolerance limit

6. Operation

6.4.3.2 Head Temperature Limit

The Head Temperature Limit allows the user to set stable limits for head temperature variations. In the Precision mode this value is preset at 2 degrees C and 4 degrees C for the industrial mode. The limits can be changed by pressing the button and entering the new value using the numeric keypad.

EN

6.4.3.3 Pressure Stability Parameters

Stability parameters for displayed pressure reading can be configured using the Pressure Stable Limit and Pressure Stable Delay buttons. When the instrument enters a stable condition the pressure indication color on the Home App will change from white to green. This window is determined by the stable limits set by pressing the Pressure Stable Limit. The Stable Delay button lets the user add a desired delay in seconds until the pressure value is considered stable while being in the stable limit window. The pressure stable limits are entered by a numeric keypad in the current pressure units.



Figure 6.4.3.3 Pressure Stability Parameters

6. Operation

6.4.4 Display Settings Application



The Display Settings Application allows the user to configure display properties like the filter for the reading to reduce fluctuations due to electrical noise, and to set the resolution of the reading. In addition, the bar graph display, tare function and uptime clock can be specified here.

EN

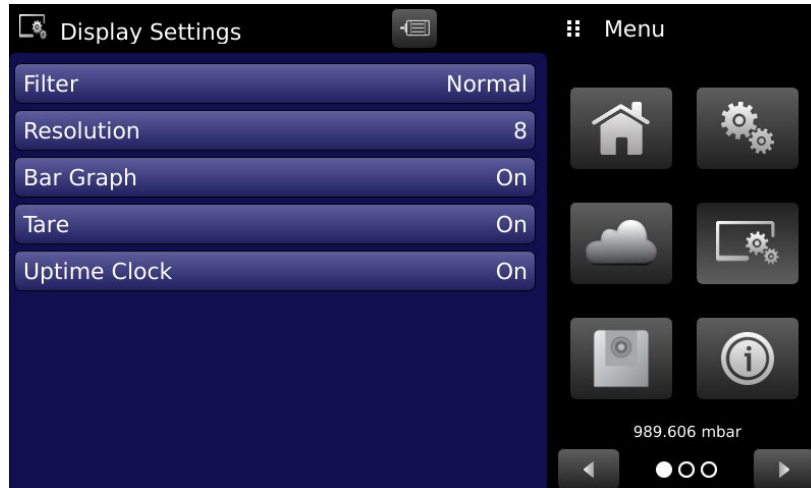

Figure 6.4.4 Display Settings App

6.4.4.1 Reading Filter

The Filter is an electronic filter to smooth out the pressure readings. Because of differences in resolution, greater filtering may display a more stable reading for some pressure units. By default the filter is set to “Off”, user can select varying degrees of filtering for the current units by selecting “Low”, “Normal” or “High”.

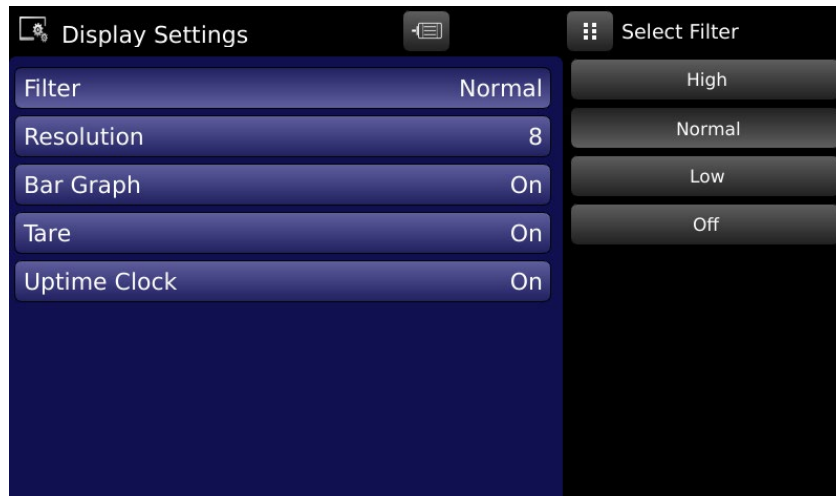

Figure 6.4.4.1 Reading Filter

6. Operation

6.4.4.2 Reading Resolution

The Resolution of the displayed pressure value can be set in the Display Settings Application using the Resolution parameter. The resolution can be set to 5, 6, 7 or 8 digits.

EN

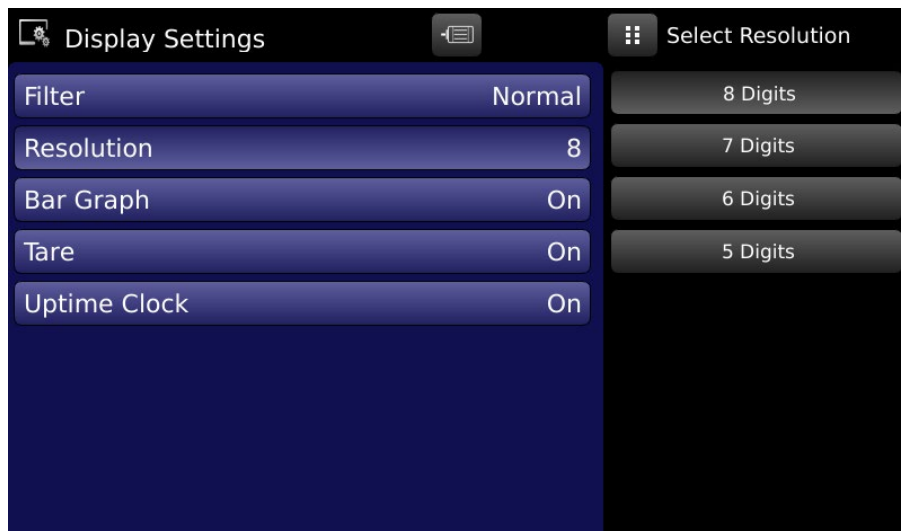

Figure 6.4.4.2 Reading Resolution

6.4.4.3 Bar Graph

The Bar Graph visible on under the displayed pressure value can be turned on/off in the Display Settings Application. The bar graph indicates the relative position of the current value with the maximum range of active measuring head.

6.4.4.4 Tare

Turning the Tare button "On" will enable the Tare Cal Button [] in the Home App. See 6.4.1.8 Tare Button for operation of the Tare button in the Home App (main screen).

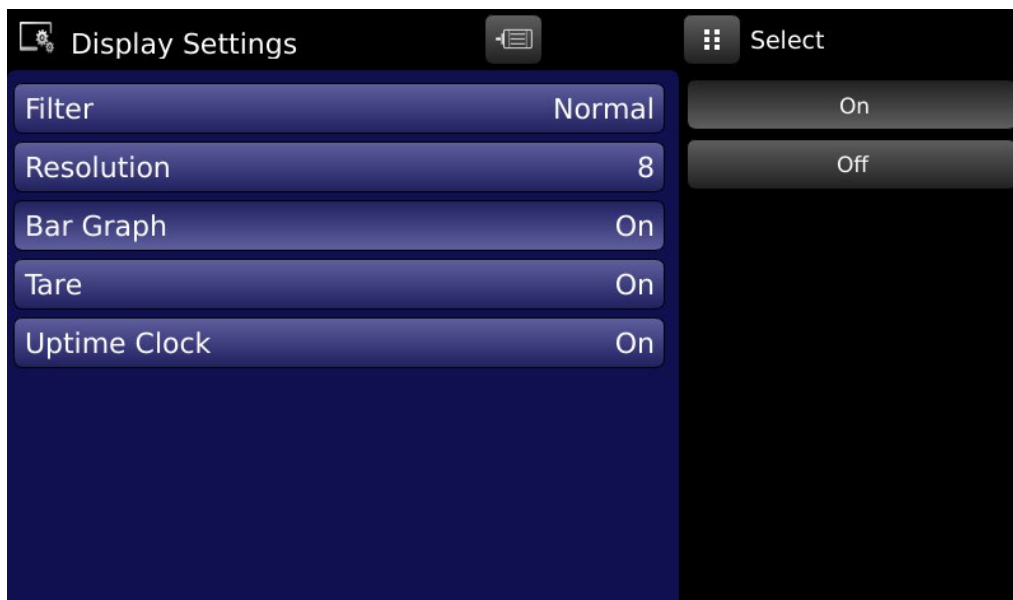

Figure 6.4.4 Tare Button

6. Operation

6.4.4.5 Uptime Clock

Turning the Uptime Clock button “On” will enable the Uptime Clock indication in the Home App. See 6.4.1.7 Uptime Clock for the operation of the Uptime Clock button in the Home App (main screen).

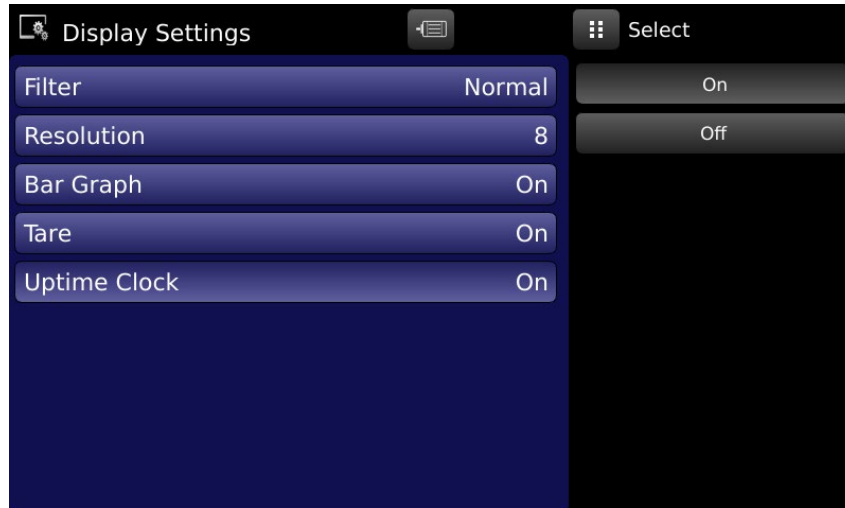

Figure 6.4.4.5 Uptime Clock Button

6.4.5 Head Information Application



With the Head Information App users can select an active head and get information on head parameters (Figure 6.4.5-A Head Information App). All the head parameters relevant to the head including the type of head, pressure range, absolute & gauge Kn values, distortion coefficients, motor type, motor limit and accuracy are displayed in the App. Pressing the Selected Head button displays a drop down list of heads pre saved in the instrument's memory. The current head can be selected by clicking on the desired head from the list (Figure 6.4.5-B).

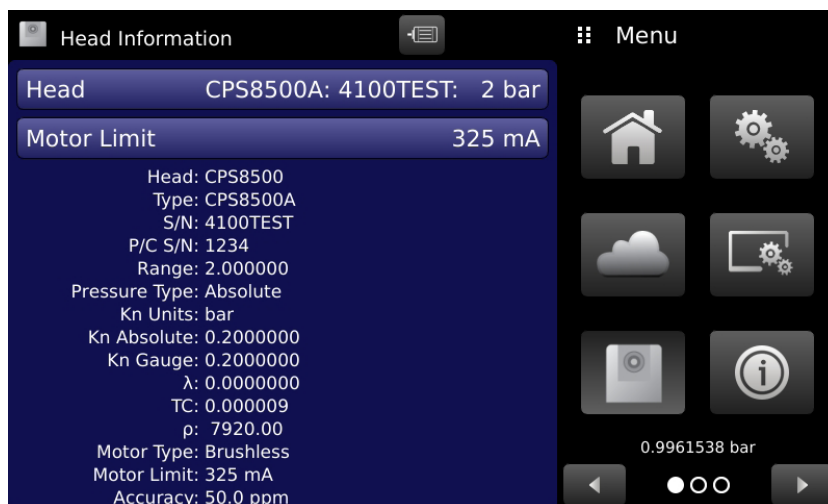

Figure 6.4.5-A Head Information App

The motor limit button indicates a number corresponding to the current drawn by the motor. The motor limit is also part of the pre saved head data and is automatically changed with the change in active head. The user can change this limit as desired when changing or replacing motors (Figure 6.4.5-C).

6. Operation

EN



WARNING!

The motor limit should be changed with caution as a false motor limit could lead to a motor failure or a false detection of the piston cylinder health.



Figure 6.4.5-B Head Selection



Figure 6.4.5-C Motor Limit

Following is a list of head parameters displayed on the screen:

- **Type:** Displays the type of head, CPS8500A, CPS8500G, Legacy (610, 410,110,111).
- **S/N:** The serial number of the measuring head.
- **P/C S/N:** The serial number of the piston cylinder system inside the head.
- **Range:** The maximum full scale range of the measuring head shown in it's Kn units.
- **Pressure Type:** The native pressure type of the head.
- **Kn Units:** The pressure units in which the Kn and the measuring range is defined.
- **Kn Absolute/Gauge:** The Kn value in absolute or gauge mode of the measuring head.
- **Distortion Correction:** Displays the distortion correction coefficient (λ) indicating the distortion caused by applying pressure on the measuring head.
- **Temperature Correction:** Displays the temperature correction factor (TC) set for the active measuring head.
- **Density Correction:** Displays the density correction coefficient (ρ) for the active measuring head.
- **Motor Type:** Displays Brushed or Brushless
- **Motor Limit:** Displays the current limit for the motor
- **Accuracy:** Displays the calibrated accuracy of the measuring head.

6.4.5.1 Head Information for CPS8500A and CPS8500G

The CPS8500A and CPS8500G are equipped with onboard flash memory that stores all of the head information. When the CPS8500 is engaged with the base, the base will begin to read the information from the head (Figure 6.4.5.1-A). Once the read is complete, the instrument software will prompt the user to reinitialize the loadcell. It is recommended that the load cell be reinitialized every time a new head is connected. This allows the loadcell to calibrate itself based on the pre-load of the head. If "Yes" is selected, the initialization process will begin (Figure 6.4.5.1-C).

6. Operation

EN

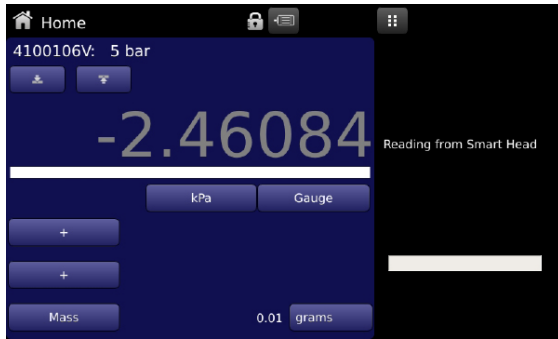

Figure 6.4.5.1-A Reading Head Information

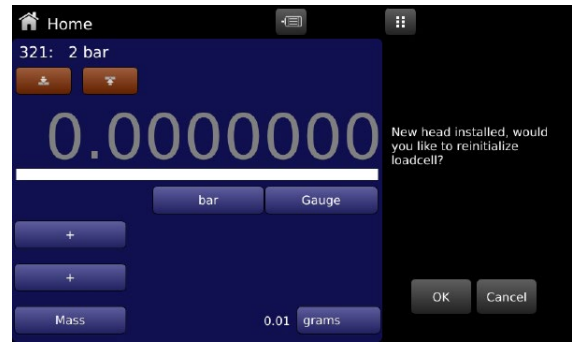

Figure 6.4.5.1-B Reinitialize Loadcell

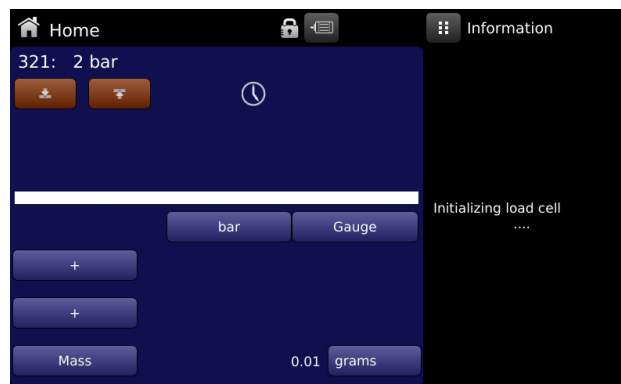



Figure 6.4.5.1-C Initializing Loadcell

Once the initialization is complete, the CPS8500 head information will be stored to the base. The "Select Head" application will display an up and down arrow  (Figure 6.4.5-B) to signify that the head information is CPS8500 and the connection is active. Any changes made to the head information will be saved to both the CPD8500 and the CPS8500. This allows for easy transitions between heads and also prevents misinformation from used. If a head data file on the CPD8500 and CPS8500 do not match, the user will be prompted to select which information is correct (Figure 6.4.5.1-D). Once the user corrects the mismatched information, the two files will sync together and display "sync successful" (Figure 6.4.5.1-E).

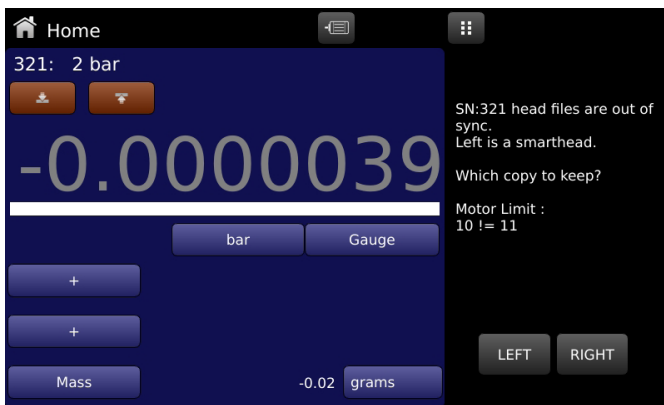

Figure 6.4.5.1-D Sync Data

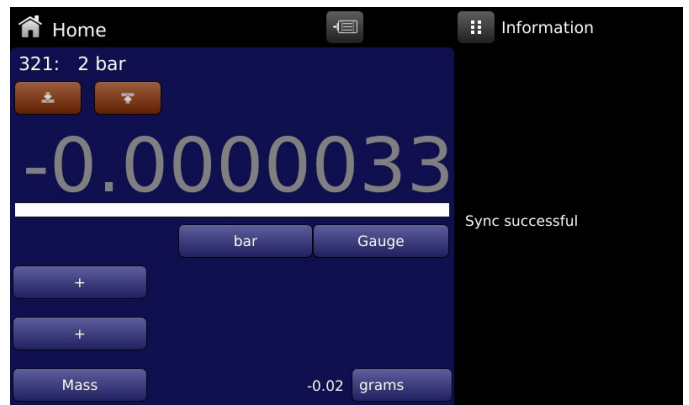



Figure 6.4.5.1-E Sync Successful

PN 0019408001G 09/2022 EN

6. Operation

Remote Settings Application



The Remote Settings Application is accessed by pressing the page forward [] button at the bottom of the screen. With the Remote Settings application users can select the remote command set for all interfaces. The GPIB address, Ethernet network parameters and Serial parameters can also be set here.

EN

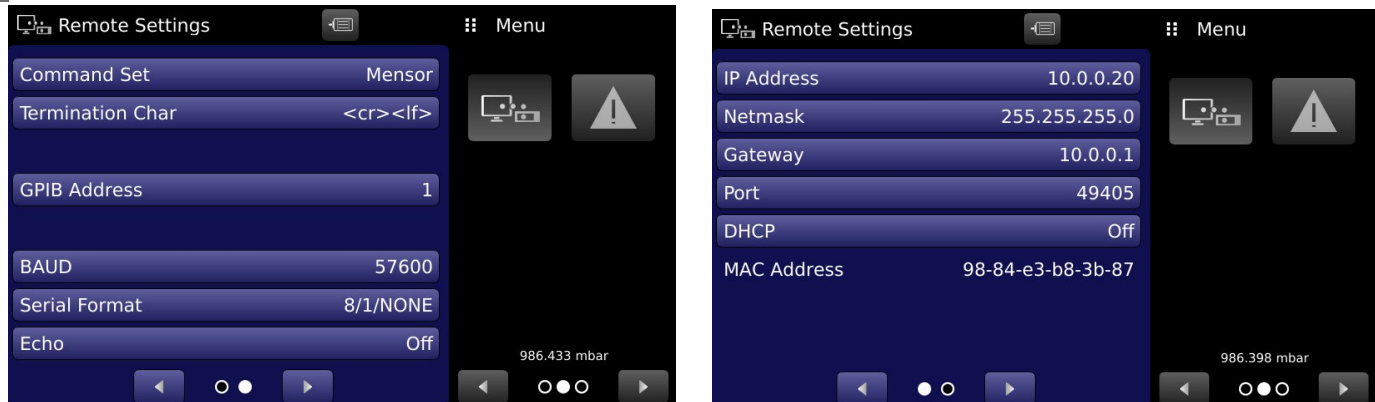

Figure 6.4.6 Remote App

6.4.5.2 Remote Command Set

The remote command set parameter provides a choice of the Mensor command set or the CPD8000 command set (Figure 6.4.6.1-A). All sets of commands are listed in Section 8, Remote Operation. The termination character sets the output termination character for all remote communication command sets (Figure 6.4.6.1-B).

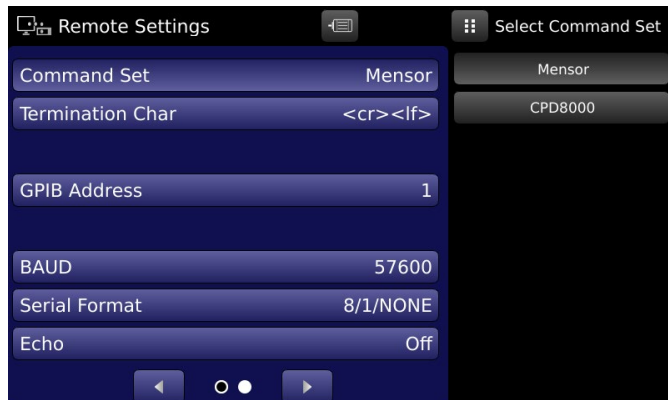

Figure 6.4.6.1-A Remote Command Set

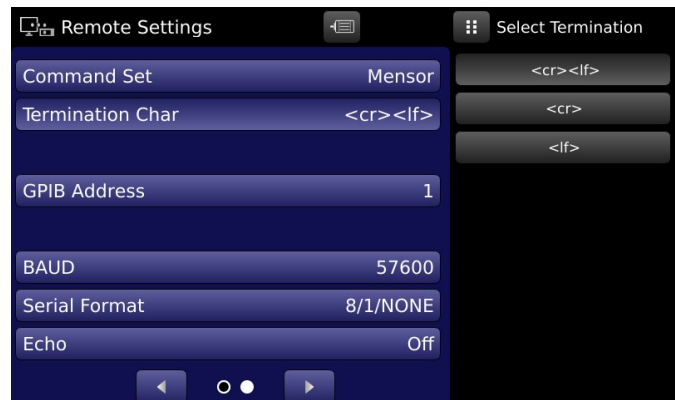

Figure 6.4.6.1-B Termination Character

6. Operation

6.4.5.3 Remote Communication Settings

The remainder of the Parameters in the Remote Application (Fig. 6.4.5.3-B) present the choice of a numeric entry (Fig. 6.4.5.3-A) or a radio button selection (Fig. 6.4.5.3-C). The parameters that require a numeric entry will present a numeric keypad with min and max limits for the variable. The IP address, Netmask and Gateway are displayed on page two of the Remote Settings App.

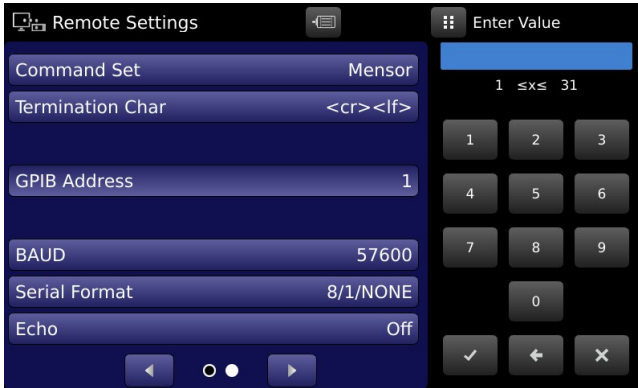

Figure 6.4.5.3-A Remote number entry



Figure 6.4.5.3-B Remote settings



Figure 6.4.5.3-C Radio button



Setting the Ethernet DHCP to yes will have a short delay while the DHCP server is contacted. If a DHCP server is not found, an error will be indicated. If DHCP is enabled, the IP address, Netmask and Gateway are locked, these are controlled by the DHCP server.

6. Operation

6.4.6 Information Application



EN

The Information Application displays information about the instrument, including:

- Address, and email.
- Base type, hardware version, serial number, manufacturing date and operating software version.
- Head model number, range, Kn value, distortion coefficient and temperature coefficient.
- Load cell serial number, environmental monitoring module serial number, software version.
- Optional sensor information, model number, serial number and software version.

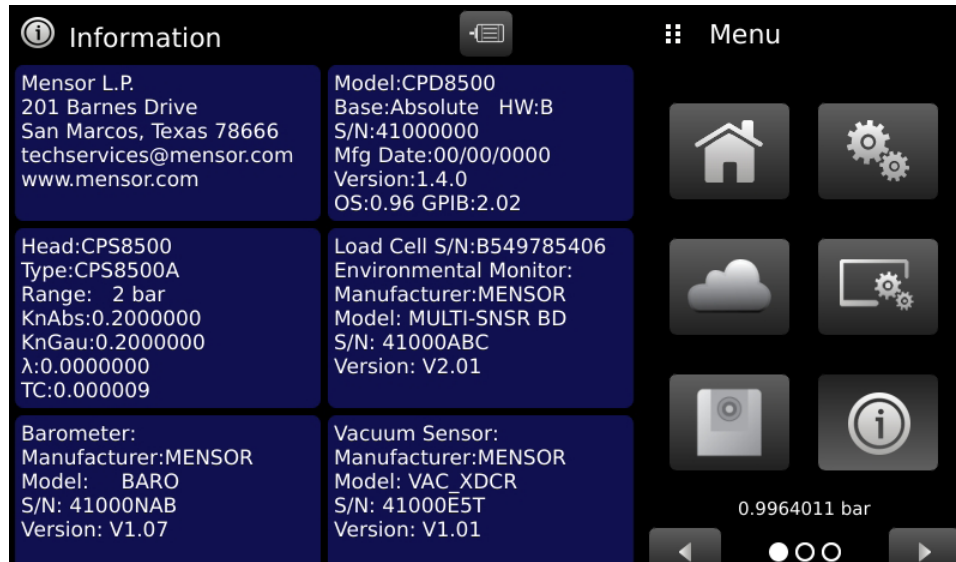





Figure 6.4.7 Information App

6. Operation

6.4.7 Troubleshooting Application



The Troubleshoot Application can be found by navigating to the second page in Apps section by clicking on the Next Page [] button. The Troubleshoot App will display information about error conditions and remote communications. Within the troubleshoot screen (Figure 6.4.8-B Troubleshoot Screen), scroll the side bar to display any errors that have occurred in the instrument due to a communication or network error. Navigating between local and remote errors can be done by pressing Page Forward [] button at the bottom of the screen. If there are any errors in the error queue an error symbol [] will appear in all screens (Figure 6.4.8-A Error Indication) of the instrument. Pressing this error button from any screen will open the Troubleshoot application where the error can be viewed.

EN

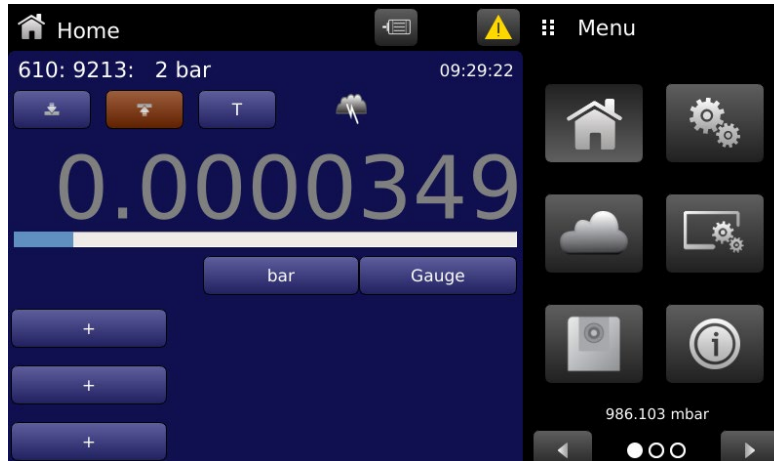

Figure 6.4.8-A Error Indication

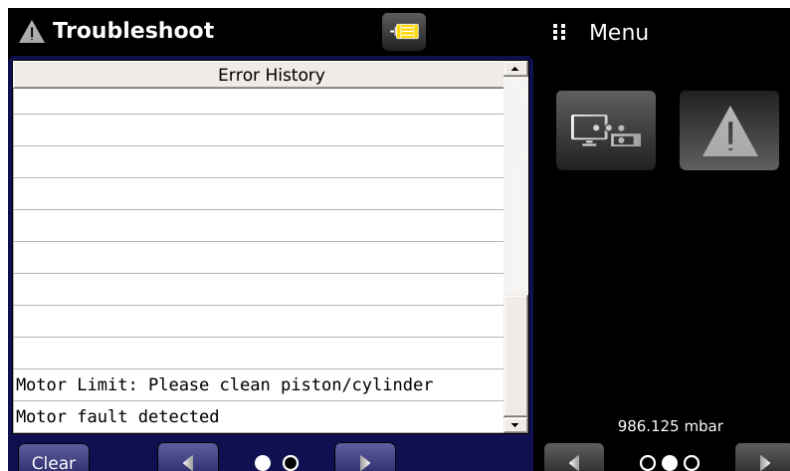

Figure 6.4.8-B Troubleshoot Screen

6. Operation

6.4.8 Service Application

EN



The service application is a password protected area where calibration of all connected transducers and devices can be accomplished. In addition, this is where the password for entering this area can be changed.

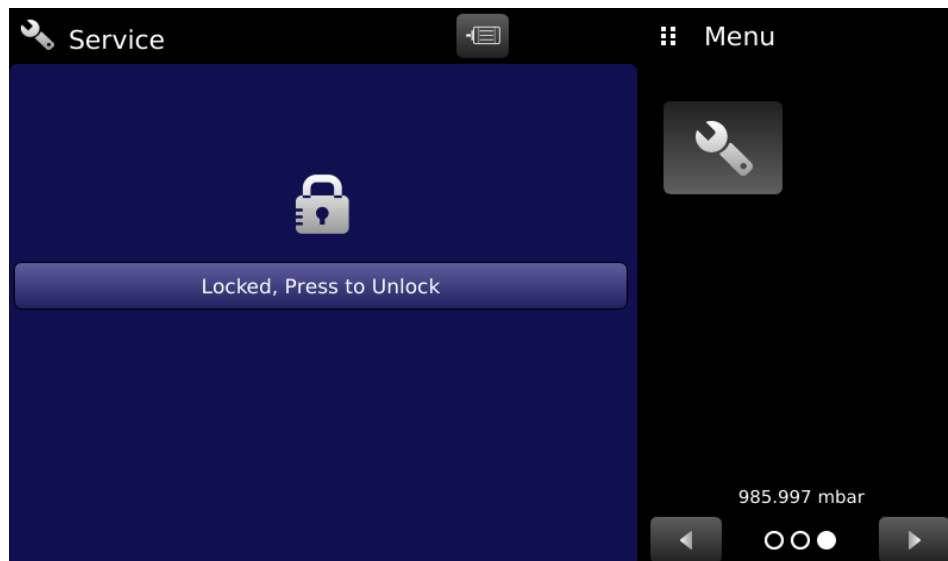



Figure 6.4.9-A Service App (Locked)

Press the Enter button to show the numeric keypad to enter a password. This will unlock applications that assist with the calibration of all devices. Default password is 123456. Enter 123456 and press the check mark [] to unlock the Service Application.



Note: The default password is 123456. After entering this for the first time, the password can be changed.

6. Operation

EN

After the Password has been entered, the unlocked Service Application will appear (Figure 6.4.10 Unlocked Service App). To re-lock this screen, press the lock button.

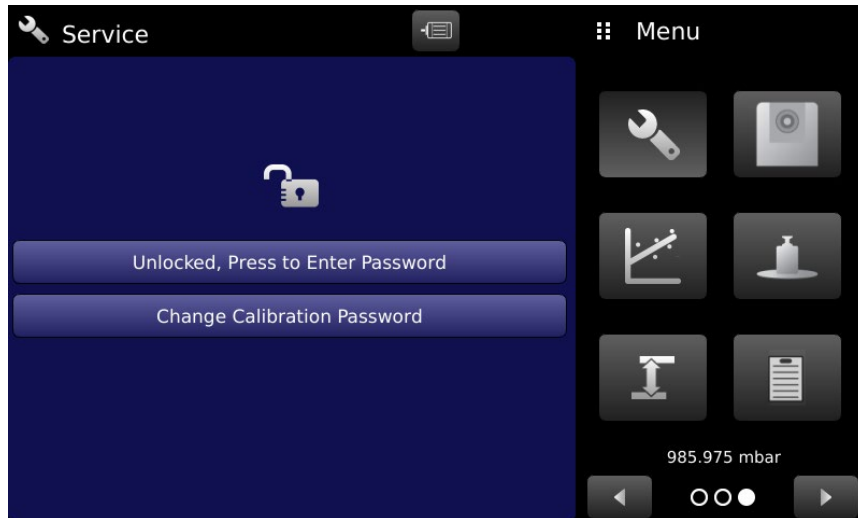



Figure 6.4.10 Unlocked Service App

From the Unlocked Service Application, the Password can be changed by pressing the Change Calibration Password button next to the Change Password label. This will open a keypad where a new password can be entered and accepted by pressing the Check Mark [].



Note: Please make note of a password change and save the new password in a secure location.

The Unlocked Service Application is the access point to all calibration screens described in Section 8. Maintenance and Recalibration of this manual.



Note: Recommended calibration setup and explanation of calibration screen applications is covered in Section 8. Maintenance and Recalibration of this manual.

7. Remote Operation

7. Remote Operation

7.1 Remote Operating Parameters

EN

Use the screens in Section 6.4.6 Remote Settings Application to set the remote operating parameters for the instrument command set, Ethernet, Serial (RS-232) and IEEE-488 (GPIB) communications.

7.2 Command Set

Command Set button – Users' can select which model remote protocol they would like to emulate for simulation and testing purposes. Selections may include the following or may be added per customers' specifications:

- Mensor
- CPD8000 (The CPD8000 mode emulates the CPD8000 command set for backwards compatibility.)

7.3 IEEE-488

IEEE-488 address button – Allows the user to set the GPIB address by inputting a numeric value utilizing the touch screen.

7.3.1 IEEE-488.2 Commands

Command	Response/ Function
*IDN?	Returns identification string

7.4 Ethernet

The Ethernet function allows the user to set the following by inputting a numeric value in each separate field:

- IP
- Netmask
- Gateway
- Port
- DHCP settings

Set the Ethernet communication parameters as described in 6.4.6 Remote Settings Application.



CAUTION! Please contact your network administrator for proper settings.



CAUTION! Please consult your computer resources department prior to connecting this instrument to your network to verify there are no conflicts with existing IP addresses.

The Ethernet communication port allows the CPD8500 to communicate with computers using 10/100Based-T specifications. Before using Ethernet communication, four parameters must be present: IP, Netmask, Gateway, and Port.

7. Remote Operation

7.5 Serial

Set the Serial communication parameters as shown in Section 6.4.6 Remote Settings Application. The serial communication port allows the CPD8500 to communicate in RS-232 format with computers, terminals, PDAs, or similar hosts.

These parameters should be set to match your host computer. Default settings are: 9600 baud, 8 data bits, 1 stop bit, no parity, and no echo.

If echo is ON, the CPD8500 will immediately echo back characters sent over the serial port. The Serial function allows the user to set the RS-232 serial port settings by selecting from the choices provided:

- Baud
 - ⇒ 9600
 - ⇒ 19200
 - ⇒ 38400
 - ⇒ 57600
 - ⇒ 115200
- Data Bits
 - ⇒ 7
 - ⇒ 8
- Stop Bits
 - ⇒ 1
 - ⇒ 2
- Parity
 - ⇒ Even
 - ⇒ Odd
 - ⇒ None
- Echo settings
 - ⇒ On
 - ⇒ Off

EN

7.5.1 Serial Cable Requirements

RS-232 communications are transmitted over a three conductor, shielded cable terminated in a standard DB9 connector on the instrument end, and a different gender connector on the host end. The proper pin-outs are shown in the following illustration.

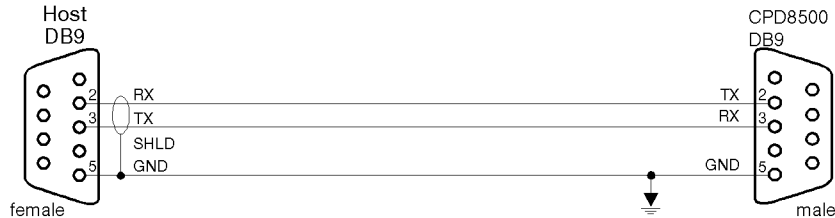

7. Remote Operation

7.6 Mensor Command Set

This Mensor command set is the default on the CPD8500. For queries (ending with a ?), the Data column represents the response of the CPD8500. All response strings begin with a space character or an "E" representing that there is an error in the error queue.

EN

All response strings are terminated with a termination character set in the Remote Settings Screen (Section 6.4.6 Remote Settings Application). The error queue holds the last 10 errors identified.

For all commands (no ?), the data column represents the required parameters to be sent to the CPD8500 following the string in the command column. For any command that requires multiple parameters to be sent, the parameters must be separated by commas.

7.6.1 Command and Query Format

Commands must be sent in ASCII format and terminated with either a carriage return (<cr>), linefeed (<lf>), or both. Commands are not case sensitive. Each query returns a response. If an error is detected the response will include an error flag.

Command or Query field: Unless otherwise specified, commands are typically converted to queries by appending a question mark to the command. Table 7.10 lists all of the CPD8500 command or query keywords.

Data field: The data field is either in ASCII {string} or numeric {value} form. In the case of multiple data fields, commas are required to separate the fields. Queries do not have a data field. String (text) or value (numeric) data are acceptable in any of the following formats:

Examples of {string} data: ON, OFF, mBar, inHg

Examples of {value} data: 1, 1.0, -5.678, 25.68324e-5

7.6.2 Command Set Definitions

In this manual a data entry made up of alpha characters is defined as a string, as opposed to data containing only numbers, such as "Enter 1 for ON or 0 for OFF" where 1 and 0 are defined as values.

Command: Any command or query listed in Table 7.6.4. For commands that take boolean data the following strings are acceptable:

0	1
False	True
No	Yes
Off	On

Separator: Space (SP).

Data: ASCII representations of numbers, {value}, or alpha characters, {string}, data as defined above. When sending code a literal variable replaces the brackets and the enclosed character(s) shown in the following examples.

Termination: Linefeed (LF) or carriage return (CR) is used to signal the end of a command statement. For IEEE-488.2 operation "EOI" is an acceptable alternative.

Always send commands in one of the following formats:

1. [Command] [Termination];
2. [Command] [Separator] [Data] [Termination];
3. Queries are special instructions in the form: [Command?] [Termination] where the question mark, "?", immediately precedes the terminator.

When a valid query is received, the CPD8500 will return {data} terminated by termination character set in the Remote Settings Screen (Section 6.4.6 Remote Settings Application). Floating point data is returned in the current engineering units in exponential format.

7.6.3 Output Formats

Pressure readings are returned in exponential notation in a format according to the OUTFORM command as follows.

Output formats

1. pressure value
2. pressure, head temperature
3. pressure value, minimum peak pressure, maximum peak pressure
4. pressure value, baro reading where baro reading is the external barometer reading if present or internal barometer reading if external is not present or "NO BAROMETER" if neither one is present
5. pressure value, head temperature reading, ambient pressure reading, ambient temperature reading, relative humidity reading
6. pressure value, barometer reading if present, vacuum sensor reading if present, head temperature reading, ambient pressure reading, ambient temperature reading, relative humidity reading

7. Remote Operation

7.6.4 Mensor Commands and Queries

Table 7.6.4 lists all of the current mensor commands and queries.

Optional emulation modes are available in which a CPD8500 can emulate remote functions of different brands of pressure gauges. Please contact Mensor for more details.

EN

Command	Data	Response/Function
?	See Section 7.6.3 Output Formats	Returns data per the current output format
Acquire?	15 char string. Ex: Acquire? Test_stand_1 Returns: <sp>(YES or NO), CCC...CCC<cr><lf>	This command is used when multiple computers would like to control the instrument. Yes if acquisition is successful. No if instrument is being controlled with another computer. CCC...= name of controlling computer (see Release? and Unlock)
Address	1-31	Sets the GPIB Address
Address?	<sp>nn<cr><lf>	Returns the GPIB Address
Ambpress?	<sp>+n.nnnnnE+nn<cr><lf>	Returns the ambient pressure from the EMM
Ambtemp?	<sp>+n.nnnnnE+nn<cr><lf>	Returns the ambient temperature from the EMM
Ambrh?	<sp>+n.nnnnnE+nn<cr><lf>	Returns the ambient humidity from the EMM
Asset_tag	16 char string.	General purpose string for customer use
Asset_tag?	<sp>ssssssssssssss<cr><lf>	Return customer asset tag string
Auxdisp <n>	NONE,UNCERTAINTY,PEAK,UNITS,HEADTEMP, AMBTEMP,AMBRH,AMBPRESS, MASS, EMM, (on absolute base only: RESPRESS)	Sets the auxiliary display setting for index <n> (1 to 3). If <n> is left out, defaults to index 1.
Auxdisp? <n>	<sp> NONE,UNCERTAINTY,PEAK,UNITS,HEAD-TEMP, AMBTEMP,AMBRH,AMBPRESS,MASS, EMM, (on absolute base only:RESPRESS) <cr><lf>	Returns the auxiliary display setting for index <n>. If <n> is left out, defaults to index 1.
Baro?	<sp>+n.nnnnnE+nn<cr><lf>	Returns reading from barometric transducer or “NO BAROMETER” if one isn’t installed
Calculate_as_found_linearity		Calculate linearity slopes and intercepts from indicated/actual input values
Caldisable	YES, NO	Sets whether or not calibration of the active sensor is disabled.
Caldisable?	<sp>(YES or NO)<cr><lf>	Returns whether or not calibration of the active sensor is disabled.
Cerr	None	Clears the error queue
CERTIFICATE	CCCCCCCCCCCC	Set
CERTIFICATE?	<sp> CCCCCCCCCCCCC <cr><lf>	Returns the calibration certificate for the active sensor
Cmdset	Mensor, CPD8000	Activates remote command set for instrument emulation modes.
Cmdset?	<sp><CCCCC><cr><lf>	Returns active command set identifier
DECPT?	<sp>n<cr><lf>	Returns the number of decimal points (see Resolution)
DHCP	ON or OFF	Reserved for DHCP setup
DHCP?	<sp>(YES or NO)<cr><lf>	Reserved for DHCP setup
DOC	mm/dd/yyyy	Sets the date of cal for the active sensor.
DOC?	<sp>mm/dd/yyyy<cr><lf>	Returns the date of cal for the active sensor.
DOM?	<sp>mm/dd/yyyy<cr><lf>	Returns the date of manufacture
ECHO	YES/NO/ON/OFF/1/0	Set the serial echo setting
ECHO?	<sp>(YES or NO)<cr><lf>	Get the serial echo setting
Error?	<sp> text description <cr><lf>	Returns the next error in the error queue

PN 0019408001G 09/2022 EN

7. Remote Operation

EN

Filter	OFF, LOW, NORMAL, HIGH	Sets the reading filter 0, 80%, 92%, 95%
Filter?	<sp>(filter)<cr><lf>	Returns the reading filter.
Gadensity	“NITROGEN” or “DRYAIR”	Sets the head pressure gas density in lb/cuft
Gasdensity?	<sp>+n.nnnnnnnE+nn<cr><lf>	Gets the head pressure gas density in lb/cuft
Gastemp	Value in degrees F	Sets the head pressure gas temperature in °F
Gastemp?	<sp>+n.nnnnnnnE+nn<cr><lf>	Gets the head pressure gas temperature in °F
Gateway	nnn.nnn.nnn.nnn	Sets the Ethernet gateway address
Gateway?	<sp>nnn.nnn.nnn.nnn<cr><lf>	Gets the Ethernet gateway address
Head <n>	1-8	Sets the active head
Head?	<sp>n<cr><lf>	Gets the active head
Headdata?	<sp><cr><lf>	Gets the active head data
Headtemp?	<sp>+n.nnnnnE+nn<cr><lf>	Returns the current head temperature
Height	Value in inches	Sets the head pressure height in inches
Height?	<sp>+n.nnnnnnnE+nn<cr> <lf>	Gets the head pressure height in inches
Id?	<sp>MENSOR,CPD8500, ssssss,v.v.vv<cr><lf>	Ssssss is the serial number,v.v.vv is the CPD8500 software version.
Industrial	ON or OFF	Sets the industrial parameters
Industrial?	<sp>(YES or NO)<cr><lf>	Returns the status of the industrial mode
Instrument_time_on?	<sp>n<cr><lf>	Returns the amount of time the instrument has been on since the last reset of the counter, in minutes
Instrument_total_time_on?	<sp>n<cr><lf>	Returns the lifetime amount of time the instrument has been on, in minutes
Instsn	SSSSSS	Loads the instrument serial number.
IP	nnn.nnn.nnn.nnn	Sets the IP address of the instrument
IP?	<sp>nnn.nnn.nnn.nnn<cr><lf>	Returns the IP address of the instrument
Keylock	YES or NO	Locks or unlocks the entire touch screen
Keylock?	<sp>(YES or NO)<cr><lf>	Returns Yes or No
Language	String	Sets the instrument language. Options are English, EnglishCA (Canadian English), EnglishGB (British English), German, French, FrenchCA (Canadian French), Spanish, SpanishMX (Mexican Spanish), Italian, Portuguese, PortugueseBR (Brazilian Portuguese), Polish, Russian, Chinese, Korean, Japanese
Language?	<sp>String<cr><lf>	Responds with the current language.
LIST?	<sp>HEAD, HEADTEMP, AMBPRESS, AMBTEMP, AMBRH, (BARO or EXTERNALBARO)<cr><lf> or <sp>NO SENSORS INSTALLED<cr><lf>	Returns list of installed sensors. Any that are not found are left out. Device list as follows: HEAD - Measuring Head HEADTEMP - Measuring head temperature probe AMBPRESS - EMM ambient pressure AMBTEMP - EMM temperature AMBRH - EMM relative humidity BARO - barometric reference EXTERNALBARO - externally connected barometric reference
Loadspan		Initiates load cell span process.

PN 0019408001G 06/2022 EN

7. Remote Operation

Loadspan_state?	IDLE/FAIL/SUCCESS/RUNNING	Returns the state of the load cell span process.
Loadtemp?	<sp>n.nnnnnnE+nn<cr><lf>	Returns the load cell temperature in current temperature units
Loadzero		Sets the zero offset for the load cell
Loadzero_state?	IDLE/FAIL/SUCCESS/RUNNING	Returns the state of load cell zero process.
Localgravity	Value in ft/s ²	Sets the local gravity in current gravity units
Localgravity?	<sp>n.nnnnnnE+nn<cr> <lf>	Returns the local gravity in current gravity units
Localgravityunits	CCCC	Set the local gravity units. Units may be m/s ² , cm/s ² , ft/s ² . Only M, CM, or F needs to be sent. Note: this setting is not saved
Localgravityunits?	<sp>CCCC<cr><lf>	Returns the local gravity units in a text string
MASS?	<sp>n.nnnnnE+nn<cr><lf>	Returns the current mass as measured by the load cell.
Motor_type	BRUSHED or BRUSHLESS	Set the head's motor type
Motor_type?	<sp>(BRUSHED or BRUSHLESS)<cr><lf>	Returns the head's motor type
Motor_limit	n	Set the head's motor current limit in mA between 10-500
Motor_limit?	<sp>n<cr><lf>	Returns the head's motor current limit in mA
Motor_speed	n	Set the head's motor speed percent from 0 to 100
Motor_speed?	<sp>n<cr><lf>	Returns the head's motor speed in percent 0 to 100
Netmask	nnn.nnn.nnn.nnn	Sets the Ethernet network mask
Netmask?	<sp>nnn.nnn.nnn.nnn<cr><lf>	Gets the Ethernet network mask
Outform	1 to 6 – see Section 7.6.3 Output Formats	Sets the output format
Outform?	<sp>X<cr><lf>	Returns the output format – see table in Section 7.10
Peakmax?	<sp>n.nnnnnE+nn<cr><lf>	Returns the maximum pressure since peakreset was sent
Peakmin?	<sp>n.nnnnnE+nn<cr><lf>	Returns the minimum pressure since peakreset was sent
Peakreset	None	Resets the peak values.
Port	nnnnnn	Sets the Ethernet port of the instrument
Port?	<sp>nnnnn<cr><lf>	Returns the Ethernet port of the instrument
Precision	ON or OFF	Sets the precision parameters
Precision?	<sp>(YES or NO)<cr><lf>	Returns the status of the precision mode
Ptype	Absolute, Gauge or Bidirectional	Sets the instrument pressure type – bidirectional only works on absolute bases if the optional barometric transducer is installed.
Ptype?	<sp>CCCCC<cr><lf>	Returns “Absolute” or “Gauge” for the pressure type in native mode and “Bidirectional” for the emulated pressure types.
RangeMax?	<sp>n.nnnnnE+nn<cr><lf>	Returns the maximum range of the active measuring head in the current units.
RangeMin?	<sp>n.nnnnnE+nn<cr><lf>	Returns the minimum range of the active measuring head in the current units.

EN

7. Remote Operation

EN

Release?	15 char string. Ex: Release? Test_stand_1 Returns: <sp>(YES or NO), CCC...CCC<cr><lf>	This command is used to release control of the instrument in a multiple computer environment. Yes if release is successful No if instrument is being controlled with another computer CCC... = name of controlling computer or AVAILABLE See: Acquire? and Unlock
Resolution	<n>	Sets the number of significant digits. (see decept)
Resolution?	<sp>n<cr><lf>	Returns the number of significant digits. (see decept)
Reset_instrument_time_on		Resets the instrument's time on counter. See usage application for more details
Sbaud	300, 600, 1200, 2400, 4800, 9600, 19200, 38400, 57600, 115200	Sets the serial and USB baud rate
Sbaud?	<sp>XXXX<cr><lf>	Returns the serial and USB baud data
Sdata	7 or 8	Sets the serial and USB data bits
Sdata?	<sp>n<cr><lf>	Returns the serial and USB data bits number
Sensor	HEAD, HEADTEMP, AMBPRESS, AMBTEMP, HUMIDITY, BARO, VAC	Sets the sensor for cal functions
Sensor?	<sp>ssss<cr><lf>	Gets the sensor for cal functions
Span		Initiates active device span process. Not valid for the head device
Span?	<sp>+n.nnnnnnE+nn<cr><lf>	Returns the active device's span multiplier. Not valid for the head device
Sparity	EVEN, ODD, NONE	Sets the serial and USB parity
Sparity?	<sp>CCCC<cr><lf>	Returns the serial and USB parity
Srqmask	"None" "Stable" "Error" "Error,Stable"	Sets the CPD8500 to issue a service request (SRQ) over the IEEE when the pressure Control is stable, or an error occurs. These are 0x02 and 0x01 in hex, respectively.
Srqmask?	<sp>{string}<cr><lf>	Returns "NONE", "STABLE", "ERROR" or "ERROR,STABLE" depending on the SRQ mask.
Sstop	1 or 2	Sets the serial and USB stop bits
Sstop?	<sp>X<cr><lf>	Returns the serial and USB stop bits
Stable?		Returns YES if instrument is stable or No
Stabledelay	0 to 120	Sets the stable time to the number of seconds specified
Stabledelay?	<sp>XXXXXXXX<cr><lf>	Returns the stable time.
Stablewin	%fs value	Sets the stable window for the active device
Stablewin?	<sp>+n.nnnnnnE+nn<cr><lf>	Returns the stable window for the active device
Tare	ON / OFF	Tares the reading to zero
Tare?	<sp> n.nnnnnE+nn <cr><lf>	Returns value of Tare
TOUCHCAL		Perform touchscreen calibration
Transfer_factory_to_linearity		Copy factory linearity coefficients to customer

PN 0019408001G 06/2022 EN

7. Remote Operation

Uncertainty?	<sp>+n.nnnnnnE+nn<cr><lf>	Returns the uncertainty in current engineering units. Dependent on the current reading, active head, and active pressure type.
Units	Units code or text in table below	Sets the instrument engineering units
Units?	<sp>CCCC<cr><lf>	Returns the instrument units in a text string
Unlock	None	Releases Acquire locks See Acquire? And Release?
Vacuum?	<sp>+n.nnnnnE+nn<cr><lf>	Returns the current residual pressure from the vacuum sensor
Zero		Sets the zero offset for the active device. Not valid for the head device
Zero?	<sp>+n.nnnnnnE+nn<cr><lf>	Returns the active device's zero offset. Not valid for the head device

EN

7. Remote Operation

7.6.5 Units Command Syntax for Measurement Units

n	Description	Output Format	Type
1	pounds per square inch	PSI	Imperial
2	inches of mercury @ 0°C	INHG	Imperial
3	inches of mercury @ 60°F	INHG	Imperial
4	inches of water @ 4°C	INH2O	Imperial
5	inches of water @ 20°C	INH2O	Imperial
6	inches of water @ 60°F	INH2O	Imperial
7	feet of water @ 4°C	FTH2O	Imperial
8	feet of water @ 20°C	FTH2O	Imperial
9	feet of water @ 60°F	FTH2O	Imperial
10	millitorr	MTORR	Metric
11	inches of sea water @ 0°C	INSW	Imperial
12	feet of sea water @ 0°C	FTSW	Imperial
13	atmospheres	ATM	Imperial
14	bars	BAR	Metric
15	millibars	MBAR	Metric
16	millimeters of water @ 4°C	MMH2O	Metric
17	centimeters of water @ 4°C	CMH2O	Metric
18	meters of water @ 4°C	MH2O	Metric
19	millimeters of mercury @ 0°C	MMHG	Metric
20	centimeters of mercury @ 0°C	CMHG	Metric
21	torr	TORR	Metric
22	kilopascals	KPA	Metric
23	pascals	PA	Metric
24	dynes per square centimeter	DY/CM ²	Metric
25	grams per square centimeter	G/CM ²	Metric
26	kilograms per square centimeter	KG/CM ²	Metric
27	meters of sea water @ 0°C	MSW	Metric
28	ounce per square inch	OSI	Imperial
29	pounds per square foot	PSF	Imperial
30	tons per square foot	TSF	Imperial
32	micron of mercury @ 0°C	mHG	Metric
33	tons per square inch	TSI	Imperial
34	meters of mercury @ 0°C	MHG	Metric
35	hectapascals	HPA	Metric
36	megapascals	MPA	Metric
37	millimeters of water @ 20°C	MMH2O	Metric
38	centimeters of water @ 20°C	CMH2O	Metric
39	meters of water @ 20°C	MH2O	Metric

EN

PN 0019408001G 06/2022 EN

7. Remote Operation

7.7 CPD8000 Command Set

The CPD8500 uses CPD8000 command set to emulate the remote communication used in its predecessor CPD8000 and DPG5, DPG8 and DPG10.

7.7.1 Command and Query Format

Commands must be sent in ASCII format and terminated with either a carriage return (<cr>), linefeed (<lf>), or both. Commands are not case sensitive. Each query returns a response. If an error is detected the response will include an error flag.

Command or Query field: Unless otherwise specified, commands are typically converted to queries by appending a question mark to the command. Table 7.7.3 lists all of the CPD8500 command or query keywords.

7.7.2 Command Set Definitions

In this manual a data entry made up of alpha characters is defined as a string, as opposed to data containing only numbers, such as "Enter 1 for ON or 0 for OFF" where 1 and 0 are defined as values.

Command: Any command or query listed in Table 7.7.3. The commands, which are indicated with '=' (query & return) can be used either to read or to determine a value.

Separator: Space (SP).

Data: ASCII representations of numbers, {value}, or alpha characters, {string}, data as defined above. When sending code a literal variable replaces the brackets and the enclosed character(s) shown in the following examples.

Termination: Linefeed (LF) or carriage return (CR) is used to signal the end of a command statement. Therefore, the message is a character chain, with CR and LF marking the end of the chain.

When a valid query is received, the CPD8500 will return {data} terminated by CR and LF.

When a command is not supported, the received message is answered back and followed by ?

Status of the instrument: When the CPD8500 is performing the calibration, the zeroing or the configuration of the DPM, no other command are valid. The CPD8500 answer STS=1 until the action in progress is finished.

The command STS can be used to check if one the action mentioned is completed (STS=0) or not (STS=1). The command ERR should be used to check if the action succeed (ERR=0) or not.

7.7.3 CPD8500 Commands and Queries

Table 7.7.3 lists all of the current Mensor commands and queries. Commands which have (**) at the end are currently not supported by the CPD8500.

Command	Query & Return	Description	Unit	Typical Response
ABS		Test if absolute or gauge mode		ABS = ON or ABS = OFF ABS= ON if DPM connected or vacuum < 20Pa (CPD8000 A)
ATM		Ambient atmospheric pressure EMM sensor measurement	hPa	1013 hPa
BLC	=	Measuring head number		2
BRM**	=	Initialisation of the external barometer		BRM = 0 or BRM = 1
CAL		Calibration		CAL = S or CAL = N
COM	=	RS232 communication rate	Baud	9600
DAT**	=	Date (dd-mm-yyyy)		12-05-1997
DIG	=	Selection of the number of digits		2
ERR (2)		Error code		ERR = 0
ESC**		Cancellation of the modifications		ESC = Y or ESC = N
FIL	=	Selection of the filter		0
HUM		Relative ambient humidity EMM sensor measurement	%	68.3 %

7. Remote Operation

EN

IDN		Identification of the standard, version of the internal software and serial number		DPG - Ver 3.15 - 9707
LCL		Return to local mode		LCL = OK
MPB		Barometric pressure external sensor measurement	Pa	101325 Pa
MPI		Immediate pressure measurement		S (stable) 8952.31 mbar I (unstable) 8952.31 mbar
MPR		Repeated pressure measurement		MPR : mbar 8952.31 8953.24
MPV		Reading of the residential vacuum	Pa	2.03 Pa
MVL		Instantaneous air mass density	kg/m ³	1.22 kg/cm ³
NBA**	=	External barometer serial number		9918
NBC	=	Measuring head serial number		99101
NPC	=	P/C assembly serial number		7658
OPI	=	Offset of the Pirani		0.02
PAC**		Coefficient Pa of the DPM		
PAS	=	Password confirmation		
PMC**		Coefficient PM of the DPM		
PUN	=	Pressure unit		4
RNG		CPD 8000 measuring range according to the selected measuring block.		0.07 bar
RPC**	=	Head temperature probe resistance	Ohm	100.02
RST	=	Reset to default values		
SAV**		Modifications saving		SAV = Y or SAV = N
SGL	=	Local gravity value	m/s ²	9.80665
SI (1)		Measuring cell measured value	g	S * 809.27 g
SMV	=	External calibration masses density	kg/m ³	7920
SPC	=	Piston-cylinder Kn		20.000123
STS (3)		CPD8000 status		STS = 1 (busy) if CAL, TAR, BRM
T (1)		Cell tarring		TA (ok) or TL (not ok)
TAM		Ambient temperature EMM sensor measurement	°C	23.2 °C
TAR	=	Standard's tarring		TAR = S
TIM**	=	Time (hh-mm-ss)		15-56-22
TPC		Piston temperature	°C	24.6 °C
TST		Calibration test		TST = S TST = 0.00
UPC	=	Kn unit (bar or psi)		0 (bar/kg), 1 (psi/kg)
UUC	=	User unit coefficient		0.5
UUN**	=	User unit label		USER
WNG		Calibration indication		
ZST	=	Pressure stability selection	(P/s unit)	0,01 (mbar/s)

PN 0019408001G 06/2022 EN

7. Remote Operation

7.8 Error Codes

Error Codes	Error Text
General Errors	
ERR_NONE	No Error
ERR_OPEN	Device Open Error
ERR_NOT_CONNECTED	Device Not Connected Error
ERR_TIMEOUT	Device Timeout
ERR_COMMUNICATION	Communication Error
ERR_BUFFER_OVERFLOW	Buffer Overflow Error
ERR_FILE_CHECK	File Check Error
ERR_NOT_ASSIGNED	Unassigned Function Error
ERR_STATUS	New Status
Application or Device Specific Errors	
ERR_HDF_FILE_NOT_FOUND	Saved HDF not found. Set to next available
ERR_HDF_NO_VALID_FILE_FOUND	No HDF found. Create new or copy from USB
ERR_CALIBRATION	Calibration Error
ERR_CALIBRATION_SPAN_READING_TOO_LOW	Cal Error: Unable to set span below 50%
ERR_CALIBRATION_LINEARITY_INDEX	Linearity index: See LINEARITY_PTS
ERR_CALIBRATION_LINEARITY_INPUT_DATA	Cal Error: Data entry incomplete
ERR_CALIBRATION_LINEARITY_UNABLE_CORRECT	Cal Error: Unable to adjust. Check input data
ERR_CALIBRATION_LINEARITY_SEGMENT_CHECK	Cal Error: Segment discontinuity
ERR_CALIBRATION_LINEARITY_LIMIT	Linearity point limit error
ERR_CALIBRATION_LINEARITY_LIMIT_DOWNSCALE	Linearity downscale limit error
ERR_CALIBRATION_LINEARITY_LIMIT_UPSCALE	Linearity upscale limit error
ERR_CALIBRATION_LINEARITY_REFERENCE_DIRECTION_MISMATCH	Direction mismatch: see LINEARITY_REF_DIRECTION
ERR_CALIBRATION_LINEARITY_READING_DIRECTION_MISMATCH	Direction mismatch: See LINEARITY_RDG_DIRECTION
ERR_ETHERNET_ACCESS_CONFIG	Ethernet: Access denied. Default
ERR_ETHERNET_SAVE_CONFIG	Ethernet: Unable to save config (file open)
ERR_ETHERNET_RESTORE_CONFIG	Ethernet: Unable to restore. Default
ERR_ETHERNET_DHCP	Ethernet: No DHCP server
ERR_ETHERNET_SOCKET_OPEN	Ethernet: Unable to mark socket for listening
ERR_ETHERNET_SOCKET_BIND	Ethernet: Unable to bind network socket
ERR_ETHERNET_SOCKET_CREATION	Ethernet: Unable to create network socket
ERR_MOTOR_FAULT	Motor fault detected
ERR_MOTOR_OVER_THRESHOLD	Motor Limit: Please clean piston/cylinder
ERR_MOTOR_NOT_CONNECTED	Motor Fault : Check motor cable
ERR_LOADCELL_INIT	Load cell: Initialization error
ERR_LOADCELL_INIT_MODE	Load cell: Unable to initialize mode
ERR_LOADCELL_INIT_MODE_BAD	Load cell: Initialization bad mode
ERR_LOADCELL_INIT_AUTOZERO	Load cell: Unable to initialize autozero
ERR_LOADCELL_INIT_AUTOZERO_BAD	Load cell: Initialization bad autozero

PN 0019408001G 09/2022 EN

7. Remote Operation

EN

ERR_LOADCELL_INIT_UNIT	Load cell: Unable to initialize units
ERR_LOADCELL_INIT_BAD_UNIT	Load cell: Initialization bad units
ERR_LOADCELL_INIT_CAL	Load cell: Unable to initialize calibration
ERR_LOADCELL_INIT_BAD_CAL	Load cell: Initialization bad calibration
ERR_LOADCELL_CAL_TEST_TIMEOUT	Load cell: Cal Test process timed out
ERR_LOADCELL_CAL_TEST_ABORT	Load cell: Cal Test aborted
ERR_LOADCELL_CAL_TEST_IMPOSSIBLE	Load cell: Cal Test not possible
ERR_LOADCELL_CAL_TEST_NOT_PERFORM	Load cell: Cal Test not performed
ERR_LOADCELL_TARE_TIMEOUT	Load cell: Tare process timed out
ERR_LOADCELL_TARE_DISABLE	Load cell: Tare disable not performed
ERR_LOADCELL_TARE_NOT_PERFORM	Load cell: Tare not performed
ERR_LOADCELL_TARE_LOWER_LIMIT	Load cell: Tare lower limit exceeded
ERR_LOADCELL_TARE_UPPER_LIMIT	Load cell: Tare upper limit exceeded
ERR_LOADCELL_ZERO	Load cell: Zero calibration process error
ERR_LOADCELL_ZERO_TIMEOUT	Load cell: Zero calibration process timed out
ERR_LOADCELL_ZERO_NOT_PERFORM	Load cell: Zero calibration not performed
ERR_LOADCELL_ZERO_LOWER_LIMIT	Load cell: Zero lower limit exceeded
ERR_LOADCELL_ZERO_UPPER_LIMIT	Load cell: Zero upper limit exceeded
ERR_LOADCELL_SPAN	Load cell: Span calibration process error
ERR_LOADCELL_SPAN_NOT_START	Load cell: Span calibration process not started
ERR_LOADCELL_SPAN_ABORT	Load cell: Span process aborted
ERR_LOADCELL_SPAN_TIMEOUT_1	Load cell: Span first process timed out
ERR_LOADCELL_SPAN_TIMEOUT_2	Load cell: Span second process timed out
ERR_LOADCELL_OVERRANGED	The load cell was overranged
ERR_ETHERNET_ACCESS_CONFIG	Ethernet: Access denied. Default
ERR_ETHERNET_SAVE_CONFIG	Ethernet: Unable to save config (file open)
ERR_ETHERNET_RESTORE_CONFIG	Ethernet: Unable to restore. Default
ERR_ETHERNET_DHCP	Ethernet: No DHCP server
ERR_ETHERNET_SOCKET_OPEN	Ethernet: Unable to mark socket for listening
ERR_ETHERNET_SOCKET_BIND	Ethernet: Unable to bind network socket
ERR_ETHERNET_SOCKET_CREATION	Ethernet: Unable to create network socket
ERR_NONVOLATILE	PowerOn error
ERR_NONVOLATILE_NOSD	No SD card found. Changes will not be saved.
ERR_NONVOLATILE_INVALID_ROW	Check SD Card: Data not saved (row invalid)
ERR_NONVOLATILE_INVALID_ROW_CFG	Check SD Card: Data not saved (row cfg invalid)
ERR_NONVOLATILE_INVALID_ROW_SEN	Check SD Card: Data not saved (row sen invalid)
ERR_NONVOLATILE_INVALID_ROW_MOD	Check SD Card: Data not saved (row mod invalid)
ERR_NONVOLATILE_INVALID_TABLE	Check SD Card: Data not saved (table invalid)
ERR_NONVOLATILE_INVALID_PARAMETER	Check SD Card: Data not saved (column invalid)
ERR_NONVOLATILE_DB_CLOSED	Check SD Card: Data not saved (db closed)
ERR_NONVOLATILE_INSERT	Check SD Card: Data not saved (insert)
ERR_NONVOLATILE_DUPLICATE	Duplicate save location found
ERR_NONVOLATILE_SAVE_CONFIG	Error saving configuration
ERR_NONVOLATILE_LOAD_CONFIG	Error loading configuration
ERR_NONVOLATILE_LOAD_CONFIG_PARAM	Error loading configuration setting

PN 0019408001G 06/2022 EN

7. Remote Operation

ERR_NONVOLATILE_SELECT_CONFIG_INDEX	Select configuration before saving or loading
ERR_LOADCELL_INIT_COMMUNICATION	Could not initialize load cell
ERR_LOADCELL_OVERRANGED	The load cell was overranged
ERR_HEAD_FILE_VERSION	Unrecognized head file version
ERR_HEAD_TEMPERATURE_UNREASONABLE	Head temperature is an unreasonable value
ERR_AMBIENT_PRESSURE_UNREASONABLE	Ambient pressure is an unreasonable value
ERR_AMBIENT_PRESSURE_OUT_OF_CALIBRATED_RANGE	Ambient pressure out of compensated range
ERR_RELATIVE_HUMIDITY_UNREASONABLE	Relative humidity is an unreasonable value
ERR_RELATIVE_HUMIDITY_OUT_OF_CALIBRATED_RANGE	Relative humidity out of compensated range
ERR_AMBIENT_TEMPERATURE_UNREASONABLE	Ambient temperature is an unreasonable value
ERR_AMBIENT_TEMPERATURE_OUT_OF_CALIBRATED_RANGE	Ambient temperature out of compensated range
ERR_SH_DISCONNECTED	CPS8500 head disconnected.
ERR_EMM_NOT_CONNECTED	Head temp probe not found
Remote Errors	
ERR_UNSUPPORTED_DEV	Device Command Not Supported Error
Mensor Command Set Specific Errors	
ERR_SYNTAX	Syntax Error
ERR_PARAMETER	Parameter Error
ERR_INDEX_OUT_OF_RANGE	Index Out of Range Error
ERR_NUMERIC_FORMAT	Number Format Error
ERR_FAILED_CMD	Failed Command Error
CPD8000 Command Set Specific Errors	
ERR_DH_REMOTE_CMD	0 Communication Error - Bad Command
ERR_DH_UNSTABLE	1 Load Cell Unstable - Unable to tare or cal
ERR_DH_NOT_AT_ZERO	2 Load Cell Not at Zero - Unable to cal
ERR_DH_BARO_INIT_FAILED	3 Barometer Initialization Failed
ERR_DH_CELL_OVERLOAD	4 Load Cell Over loaded
ERR_DH_CELL_UNDERLOAD	5 Load Cell Under loaded
ERR_DH_READING_IN_MENU	6 Pressure Reading in Menu Mode
ERR_DH_TARE_FAIL	7 Calibration Test Failed
ERR_DH_BARO_INIT_FAILED	3, Barometer Initialization Failed
ERR_DH_CELL_OVERLOAD	4, Load Cell Over loaded
ERR_DH_CELL_UNDERLOAD	5, Load Cell Under loaded
ERR_DH_READING_IN_MENU	6, Pressure Reading in Menu Mode
ERR_DH_TARE_FAIL	7, Calibration Test Failed

EN

8. Maintenance and Recalibration

8. Maintenance and Recalibration

EN



For contact details, please see chapter 1 “General information” or the back page of the operating instructions.

8.1 Maintenance

The CPD8500 was designed for maintenance-free operation beyond period maintenance and cleaning on the measuring head. User maintenance is not recommended, beyond replacement of parts listed in Table 8.1.3. If you have questions not covered by this manual, call 1-800-984-4200 (USA only), or 1-512-396-4200 for assistance, or send an email to tech.support@mentor.com.

8.1.1 Beyond the Warranty

Take advantage of Mensor’s expert product care. Mensor provides complete maintenance and calibration services, available for a nominal fee. Our service staff is knowledgeable in the innermost details of all of our instruments. We maintain units that are in operation in many different industries and in a variety of applications, and by users with a wide range of requirements. Many of these instruments have been in service for over twenty years, and continue to produce excellent results. Returning your instrument to Mensor for service benefits you in several ways:

- Our extensive knowledge of the instrument assures you that it will receive expert care.
- In many cases we can economically upgrade an older instrument to the latest improvements.
- Servicing our own instruments which are used in “real world” applications keeps us informed as to the most frequent services required. We use this knowledge in our continuing effort to design better and more robust instruments.
- Repair or replacement of the CPD8500 chassis, module and measurement transducers will be available up to 7 years after the production life cycle of the product, pending external vendor parts or equivalent parts availability. The production life cycle is defined as the time from the product series launch to the announcement of discontinuation (typically 8 to 10 years).
- All repairs associated with the chassis or internal modules should be performed by Mensor due to the complexity of performing these repairs. Replacement of measurement transducers can be done at the customer’s site.

8.1.2 Measuring Head Cleaning

The CPD8500 prompts the user to clean the piston cylinder assembly when it detects potential contaminants within the measuring head.



WARNING!

Maintenance should be performed in a clean dust free environment.

8.1.2.1 CPS8500A Absolute Measuring Head

The following instructions apply to all CPS8500A absolute measuring heads. The type of maintenance described below should be performed in a clean, dust free environment. The disassembly process shown is common to all CPS8500A measuring heads (Fig. 8.1.2.1-A).



Figure 8.1.2.1-A CPS8500A measuring head

8. Maintenance and Recalibration

Supplies

Cotton gloves

Lint-free cleaning wipes

Hex Wrenches - 2mm, 3mm and 5mm

Isopropyl Alcohol - 99.8% pure preferred (Techspray 1610-P shown)

Piston removal/insertion tool (low pressure only)

EN



Figure 8.1.2.1-B Cleaning supplies

8.1.2.1.1 CPS8500A Head Disassembly



WARNING!

Care should be taken at every step to prevent the piston/cylinder tungsten carbide surfaces from making contact with human skin or any other source of contamination. Wear cotton gloves.

Remove the protective cap from the measuring head and turn the head upside down. Remove the retaining ring screws with the 3mm hex wrench (Fig.8.1.2.1.1-A). Carefully lift the piston assembly along with the retaining ring high enough to insert the each half of the piston removal tool around the piston(Fig. 8.1.2.1.1-B). All ranges higher than 2 bar will allow you to completely remove the retaining ring before pulling the piston out. Carefully lift the piston out of the assembly while applying a small amount of clamping force on the piston removal tool (Fig. 8.1.2.1.1-C).



Figure 8.1.2.1.1-A Removing retaining ring



Figure 8.1.2.1.1-B Piston removal tool

8. Maintenance and Recalibration

EN



Figure 8.1.2.1.1-C Removing the piston

After the piston is extracted, set the piston aside for cleaning. The cylinder is inside the measuring head beneath the second retaining ring. This ring is loose and can be removed (Fig. 8.1.2.1.1-D). Once the ring is removed, place your hand over the open area of the head and invert the measuring head. This will allow the cylinder to fall into the gloved hand (Fig. 8.1.2.1.1-E). Set the cylinder aside with the piston for cleaning.

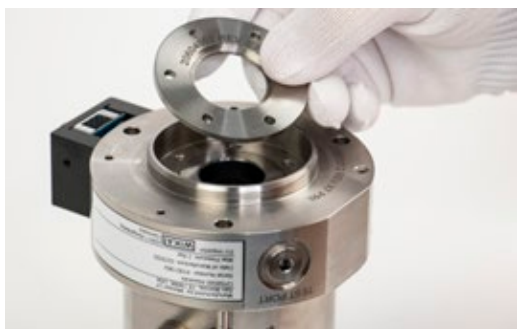

Figure 8.1.2.1.1-D Removing retaining ring

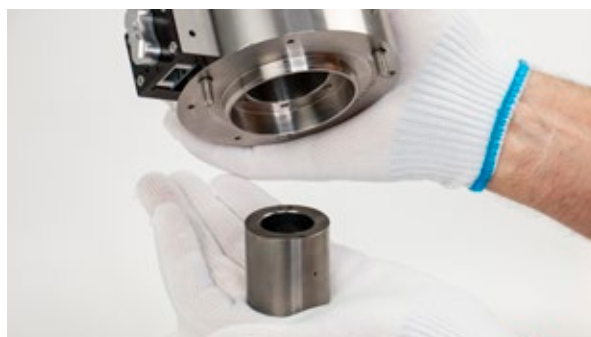

Figure 8.1.2.1.1-E Removing cylinder

8.1.2.1.2 Piston and Cylinder Cleaning Process

Clean the piston and cylinder with alcohol wetted lint-free wipes (Fig. 8.1.2.1.2-A) and dry with wipe then remove dust from both parts with compressed nitrogen. Even lint-free wipes will create microscopic dust. If the piston retaining ring needs to be removed, use the 2mm hex wrench to carefully remove side mount bearing (Fig. 8.1.2.1.2-B).



Figure 8.1.2.1.2-A Piston and cylinder cleaning

PN 0019408001G 06/2022 EN

8. Maintenance and Recalibration

EN



Figure 8.1.2.1.2-B Removing piston retaining ring

Once the cleaning process is complete, allow the piston and cylinder to return to room temperature. Then reassemble the CPS8500A in the reverse order of the disassembly instructions.

8.1.2.2 CPS8500G Gauge Measuring Head

The following instructions apply to all CPS8500G gauge measuring heads. The type of maintenance described below should be performed in a clean, dust free environment. The disassembly process shown is common to all CPS8500G measuring heads (Figure 8.1.2.2).



Figure 8.1.2.2-A CPS8500G Measuring Head

Supplies

Hydraulic Oil - Drosera for ranges up to 20 bar and Sebacate for ranges above 20 bar

Lint-free cleaning wipes

Hex Wrenches - 3mm, 3/16" and 6mm

Piston and cylinder removal tools

Syringe

Cotton gloves

Isopropyl Alcohol - 99.8% pure preferred (Techspray 1610-P shown)

Spare O-ring set

8. Maintenance and Recalibration

EN



Figure 8.1.2.2-B CPS8500G Cleaning Supplies

Drain the hydraulic oil from the head and note the condition of the oil. If it is very dark or full of particulate matter, a complete head disassembly and cleaning should be performed. The condition of the oil is based on usage and should be changed at least once a year.

8.1.2.2.1 CPS8500G Head Disassembly



WARNING!

Care should be taken at every step to prevent the piston/cylinder tungsten carbide surfaces from making contact with human skin or any other source of contamination. Wear cotton gloves.

Loosen the three 3 mm fasteners (Figure 8.1.2.2.1-A). The bayonet mount ring is spring loaded, this will push the ring upward as the fasteners are loosened. Set the springs and detents aside for use on reassembly. Carefully remove the bayonet ring along with the piston retaining ring (Figure 8.1.2.2.1-B).



Figure 8.1.2.2.1-A Removing Fasteners



Figure 8.1.2.2.1-B Removing Bayonet Ring

8. Maintenance and Recalibration

Grasp the piston head and lift up just enough to fit the piston removal tool around the piston (Figure 8.1.2.2.1-C). Gently squeeze each half of the piston removal tool while lifting the piston out of the head. Pull the piston with a swift, single motion. Ranges above 20 bar do not need a removal tool (Figure 8.1.2.2.1-D). After removal, set the piston aside for cleaning.



WARNING!

The pistons can be very fragile. Use extreme caution when removing pistons from the cylinders inside the CPS8500G measuring head.

EN



Figure 8.1.2.2.1-C Piston Removal



Figure 8.1.2.2.1-D Piston Removal

Use a 12mm hex wrench to remove the cylinder jam nut from the head assembly (Figure 8.1.2.2.1-E). Then use the cylinder removal tool to remove the cylinder. Tighten the clamp, turn, and gently move the tool back and forth to get the cylinder free from the housing (Figure 8.1.2.2.1-F). Note the cylinder positioning; there will be a small dot scribed on one side of the cylinder. This will be positioned into the tool side for re-insertion. Set cylinder aside for cleaning.



Figure 8.1.2.2.1-E Removing the cylinder jam nut



Figure 8.1.2.2.1-F Removing the cylinder



The cylinder is captured by a retaining ring that will likely be attached to the cylinder upon extraction. There is also an internal O-ring that should be inspected during the cleaning process. The retaining ring has a flat end and a stepped end. The flat end is positioned against the O-ring inside the head.

8.1.2.2.2 Cleaning the Piston and Cylinder and Reassembly

Clean piston and cylinder with alcohol and a wetted lint-free wipe (Figure 8.1.2.2.2-A). Dry with wipe then remove dust with compressed nitrogen. Note, lint-free wipes can create microscopic dust.

8. Maintenance and Recalibration



CAUTION!

The higher the range of piston, the smaller the diameter. These pistons can be easily damaged or broken, use extreme caution when handling.

EN Cleaning the small inner diameter cylinder can be a challenge. An eye dropper or hypodermic without the needle can be useful during this operation.



Figure 8.1.2.2.2-A Cleaning the piston and cylinder

When installing the cylinder back into the head, observe that one side will have a deeper chamfer than the other. The end with the larger chamfer is inserted into the head first. Some cylinders are marked with an X or a dot, these marks should be faced away from the head when installing (Figure 8.1.2.2.2-B).

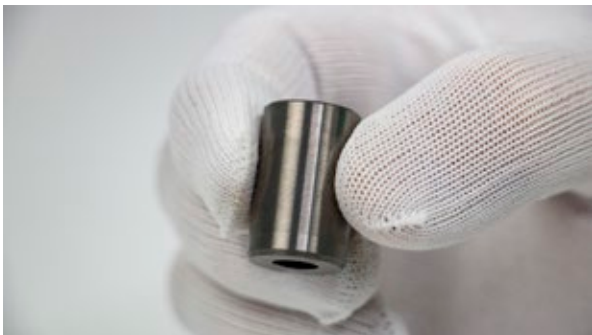

Figure 8.1.2.2.2-B Cylinder with chamfer and markings for insertion

Lightly coat the piston with a small amount of oil with a foam swab (Figure 8.1.2.2.2-C) and apply a small amount of oil to the cylinder. For cylinders with small diameter bores, apply the oil with a swab directly to the bore to allow some oil to flow inside. Reassemble the CPS8500G in the reverse order that it was disassembled and then fill with oil (Figure 8.1.2.2.2-D). Use the oil filling requirements in Section 5.3.2 to refill the CPS8500G.



Figure 8.1.2.2.2-C Swab piston with oil



Figure 8.1.2.2.2-D Fill with oil

8. Maintenance and Recalibration

8.1.2.3 Legacy Absolute Measuring Head

The following instructions apply to all absolute measuring heads (head type 610). Section Figure 8.1.2.2v Measuring Head Cleaning Supplies illustrates all the supplies needed to perform cleaning operation.

Supplies
Lint-free cotton gloves
Lint-free cleaning wipes
Distilled water
Cleaning agent (mild bar soap)
5 mm T-handle hex key wrench
Piston removal/insertion tool (required only for 1,2 and 5 bar absolute heads)
Cleaning containers

EN



Figure 8.1.2.1 Measuring Head Cleaning Supplies

8.1.2.3.1 Head Disassembly



CAUTION!

Care should be at every step to prevent the piston/cylinder tungsten carbide surfaces to make contact with human skin or any other source of contamination. The operator must wear gloves at all times during the cleaning and disassembly process.

- Place piston removal tool as shown in Section Figure 8.1.2.1 Measuring Head Cleaning Supplies. Carefully lift the piston while applying a small amount of clamping force to the piston with the tool.
- Gently and swiftly lift the piston out of the head (Figure 8.1.2.1.1-A).
- Loosen the three 5mm fasteners as shown (Figure 8.1.2.1.1-B).
- Remove top cap of head assembly (Figure 8.1.2.1.1-B).
- Note small o-ring in base and large double o-ring in cap (Figure 8.1.2.1.1-C).
- Note indexing pin for reassembly (Figure 8.1.2.1.1-C).
- Invert the base and allow the cylinder to slide out. If it does not, carefully wiggle it out (Figure 8.1.2.1.1-D).
- Note orientation of cylinder for reassembly. The serial number scribed in the cylinder inserts into the base first (Figure 8.1.2.1.1-D).

8. Maintenance and Recalibration

EN



Figure 8.1.2.1.1-A Removing The Piston From Head



Figure 8.1.2.1.1-B Removing Top Cap

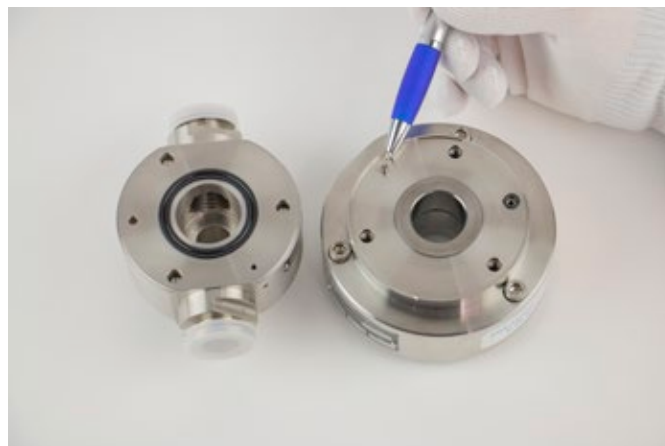

Figure 8.1.2.1.1-C O-Ring and Indexing Pin Positions

8. Maintenance and Recalibration



EN

Figure 8.1.2.1.1-D Removing Cylinder From Head

8.1.2.3.2 Head Cleaning

- Wash supplies staged with loose piston and cylinder. Distilled water should be added to each container (Figure 8.1.2.1.2-A).
- Wet several wipes in the first container of water and wipe on the bar soap. Very little is needed. Holding the piston as shown by its' stainless steel cap. Clean the tungsten surface of the piston gently. Care should be taken to not allow any of the liquid to get into the bearings on the side and bottom of the piston. If this happens be sure to rinse the bearings as best as possible (Figure 8.1.2.1.2-A)
- Next carefully rinse in the second bath with different set of wipes keeping the bearings out of the liquid. Repeat this in the third bath. Carefully dry the piston with dry wipes until all visible liquid is gone (Figure 8.1.2.1.2-B).
- Wash and rinse the cylinder in the same manner (Figure 8.1.2.1.2-B).
- The complete cylinder can be submersed for rinsing. Rinse cylinder twice also (Figure 8.1.2.1.2-B).
- Thorough drying can be accomplished by compressed nitrogen source, canned compressed air or heat gun. Allow parts to acclimate to ambient temperature conditions before reassembly. If water was introduced into a bearing the piston should be dried using heat.



Figure 8.1.2.1.2-A Piston Cleaning

8. Maintenance and Recalibration

EN



Figure 8.1.2.1.2-B Cylinder Cleaning

8.1.2.3.3 Head Reassembly

- Reassemble in reverse order of assembly process. When installing the piston using the removal/insertion tool lightly clamp the piston with the tool. Allow the piston to drop slowly into place by using less clamping force.
- The absolute heads 2 and 5 bar would require an insertion tool. A piston removal/insertion tool is not needed for 20 bar range (Figure 8.1.2.1.3).

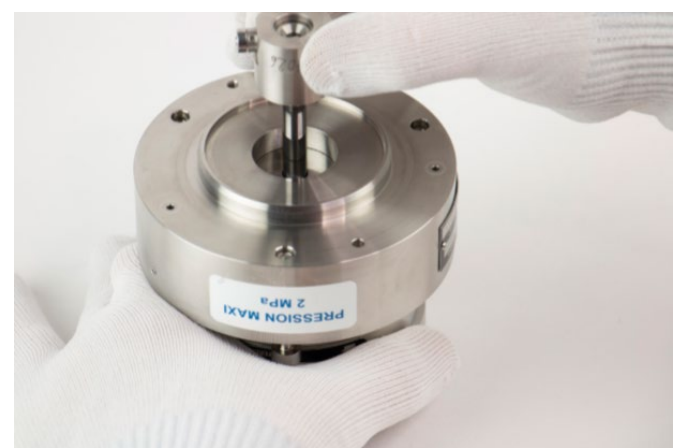

Figure 8.1.2.1.3 Measuring Head Reassembly

8.1.2.4 Low Pressure Gauge Measuring Head

These instructions apply to 1 bar, 2 bar and 5 bar gauge measuring heads only.

Supplies

- Lint-free cotton gloves
- Lint-free cleaning wipes
- Distilled water
- Cleaning agent (mild bar soap)
- Allen Wrench (3 mm)
- Piston removal/insertion tool (required only for 1,2 and 5 bar absolute heads)
- Cleaning containers

8. Maintenance and Recalibration

8.1.2.4.1 Head Disassembly



CAUTION!

Care should be at every step to prevent the piston/cylinder tungsten carbide surfaces to make contact with human skin or any other source of contamination. The operator must wear gloves at all times during the cleaning and disassembly process.

- Loosen outer set (3) of 3 mm fasteners (Figure 8.1.2.2.1-A).
- Invert the whole assembly intact and separate the two halves (Figure 8.1.2.2.1-A).
- Carefully remove the piston and set it aside for cleaning (Figure 8.1.2.2.1-B).
- Loosen the inner set of 3 mm fasteners (Figure 8.1.2.2.1-C)
- Invert the assembly intact. Allow the top cap and cylinder to slide out of the midsection (Figure 8.1.2.2.1-C).
- Note position of scribed serial number on cylinder (Figure 8.1.2.2.1-D).
- Carefully remove the cylinder from the top cap (Figure 8.1.2.2.1-D).
- Note o-ring in top cap for reassembly (Figure 8.1.2.2.1-E).



Figure 8.1.2.2.1-A Separating Measuring Head



Figure 8.1.2.2.1-B Piston Removal

8. Maintenance and Recalibration

EN



Figure 8.1.2.2.1-C Cylinder With Top Cap



Figure 8.1.2.2.1-D Cylinder Removal

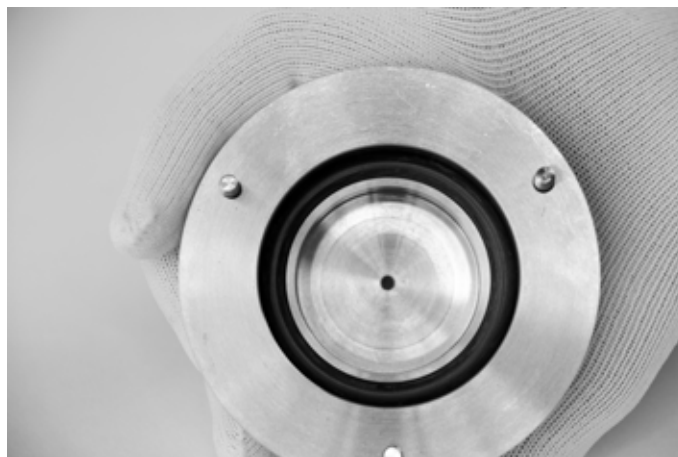

Figure 8.1.2.2.1-E Top Cap O-Ring

8.1.2.4.2 Head Cleaning

Follow the instructions in Section 8.1.2.1.2 Head Cleaning to clean the piston and cylinder for the gauge measuring head.

8. Maintenance and Recalibration

8.1.2.4.3 Head Reassembly

Reassemble in the reverse order as assembly process.

8.1.2.5 High Pressure Gauge Measuring Head

These instructions apply to 10 bar up to 500 bar gauge measuring heads only.

EN

Supplies
Lint-free cotton gloves
Lint-free cleaning wipes
Distilled water
Cleaning agent (mild bar soap)
Allen Wrench (3 mm)
Piston removal/insertion tool (required only for 1,2 and 5 bar absolute heads)
Cleaning containers
High range head service kit (Figure 8.1.5)

Figure 8.1.2.3 High Pressure Gauge Service Kit

8.1.2.5.1 Head Disassembly



CAUTION!

Care should be at every step to prevent the piston/cylinder tungsten carbide surfaces to make contact with human skin or any other source of contamination. The operator must wear gloves at all times during the cleaning and disassembly process.

Drain the hydraulic oil from the head first. Note the condition of the oil. If it is very dark or full of particulate matter a complete head disassembly and cleaning should be performed. The condition of the oil is based on usage and should be changed at least once a year. Follow the disassembly instructions below:

- Loosen outer set (3) of 3 mm fasteners (Figure 8.1.2.3.1-A).
- Invert the whole assembly intact and separate the two halves (Figure 8.1.2.3.1-A).
- Carefully remove the piston and set it aside for cleaning (Figure 8.1.2.3.1-B).
- Using the cylinder removal tool, remove the jam nut (Figure 8.1.2.3.1-C).
- Use the other end of the removal tool to clamp the cylinder (Figure 8.1.2.3.1-D).
- Using the "T" on the clamp, turn and wiggle the cylinder out of the holder (Figure 8.1.2.3.1-D).
- Carefully remove the cylinder from the top cap.
- Note the cylinder's positioning in the housing for reassembly (Figure 8.1.2.3.1-E).



Figure 8.1.2.3.1-A Separating Measuring Head

8. Maintenance and Recalibration

EN



Figure 8.1.2.3.1-B Piston Removal

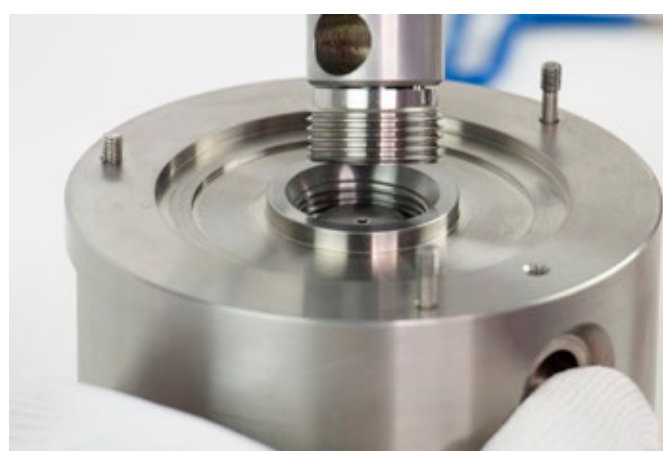

Figure 8.1.2.3.1-C Jam Nut Removal



Figure 8.1.2.3.1-D Cylinder Removal

PN 0019408001G 06/2022 EN

8. Maintenance and Recalibration

EN



Figure 8.1.2.3.1-E Cylinder Position

8.1.2.5.2 Head Cleaning

Follow the instructions in Section 8.1.2.1.2 Head Cleaning to clean the piston and cylinder for the gauge measuring head.

8.1.2.5.3 Head Reassembly

Reassemble in the reverse order as assembly process.

Following the assembly process, the high pressure gauge heads must be filled with oil. Oil should be filled with the hypodermic needle provided in the kit (Figure 8.1.2.3.3-A). Observe sight glass in front of the head while filling (Figure 8.1.2.3.3-B). Oil level should be about half way. Typically these heads require about 3 - 5 cc of oil. Once oil is filled, cover one of the pressure ports with the threaded adaptor.



Figure 8.1.2.3.3-A Oil Filling Process



Figure 8.1.2.3.3-B Sight Glass

8. Maintenance and Recalibration

8.1.3 Spare Parts

User maintenance is restricted to the parts mentioned in this section.

Table 8.1.3 Spare Parts

Part Number	Part Description
0019582001	Environmental monitoring module
0019540001	Absolute accessory kit
0019545001	Gauge accessory kit
0018780003	Vacuum transducer
0018748003	Barometric reference transducer

EN

8.1.3.1 Environmental Monitoring Module Replacement

The following steps must be followed in order to remove or replace the EMM

- Turn off the power to the instrument.
- Remove the head temperature probe from the measuring head.
- Loosen the captive screws of the EMM and remove from the chassis (Figure 8.1.3.1-A).
- Unplug cable from assembly (Figure 8.1.3.1-B).
- Ensure that the head temperature probe is part of the removal/replacement process as it is identified as a component of the EMM (Figure 8.1.3.1-C).
- Reverse the above steps to install a calibrated EMM to the chassis.
- Ensure recommended warm up time followed by on screen instructions for zeroing and span to operate the instrument.



Figure 8.1.3.1-A

8. Maintenance and Recalibration

EN



Figure 8.1.3.1-B



Figure 8.1.3.1-C

8.1.3.2 Absolute Accessory Kit Replacement

The absolute accessory kit and its components can be removed and replaced. For details on the components see Section 11.3 Absolute Accessory Kit.

8.1.3.3 Gauge Accessory Kit Replacement

The gauge accessory kit and its components can be removed and replaced. For details on the components see Section 11.5 Gauge Accessory Kit.

8.1.3.4 Vacuum Transducer Replacement

The following steps must be followed to remove or replace the vacuum transducer as part of the absolute base.

- Turn off the power to the instrument and remove the top trim plate by unscrewing three phillips pan-head screws (Figure 8.1.3.4-A).
- Separate the trim plates and remove the top and bottom parts (Figure 8.1.3.4-A).
- Remove the top cover by unscrewing the five phillips flat head screws at the rear of the cover (Figure 8.1.3.4-B).
- Tilt the cover up and slide backwards to remove (Figure 8.1.3.4-B).
- Locate the vacuum transducer at the bottom right of the chassis and unplug the cable (Figure 8.1.3.4-C).
- Remove the vacuum flange clamp (Figure 8.1.3.4-C).
- Loosen the two mounting screws on the back of the transducer (Figure 8.1.3.4-D).
- Gently remove the vacuum transducer from the chassis (Figure 8.1.3.4-D).
- Follow these steps backwards to reinstall the vacuum transducer in to the absolute chassis.

PN 0019408001G 06/2022 EN

8. Maintenance and Recalibration



EN

Figure 8.1.3.4-A Trim Plate Removal



Figure 8.1.3.4-B Top Cover Removal

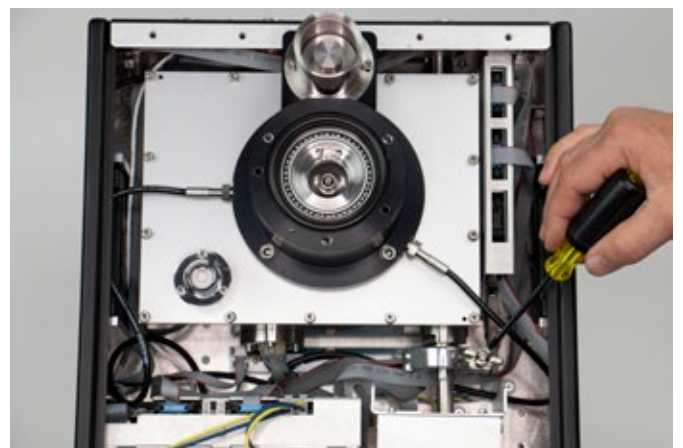

Figure 8.1.3.4-C Unplugging Vacuum Transducer

8. Maintenance and Recalibration

EN

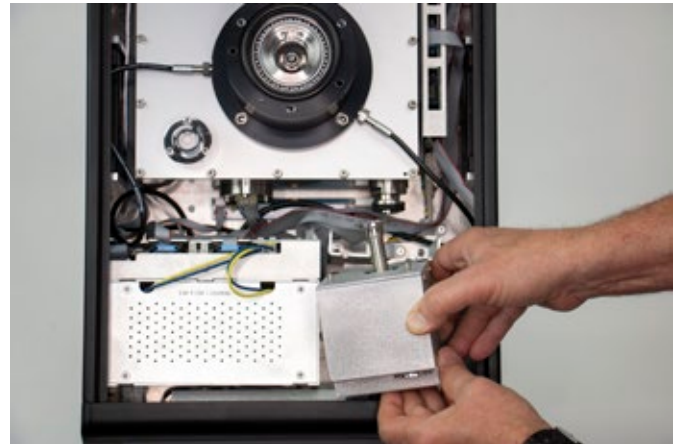
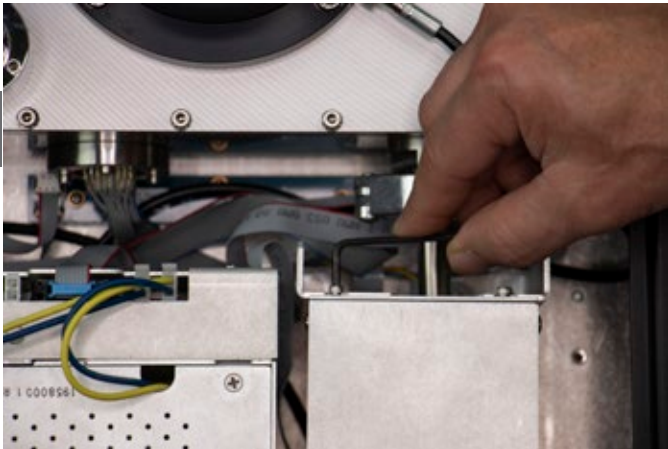

Figure 8.1.3.4-D Removing Vacuum Transducer

8.1.3.5 Barometric Reference Replacement

The following steps must be followed to remove or replace the barometric reference inside the CPD8500 chassis.

- Follow steps to remove trim plates and top cover (Figure 8.1.3.4-A and Figure 8.1.3.4-B).
- Locate the barometric reference and unplug the power cable (Figure 8.1.3.5-A).
- Unscrew the captive screw with a flathead screwdriver (Figure 8.1.3.5-A).
- Cautiously slide the barometric reference up and out of the chassis (Figure 8.1.3.5-B).



Figure 8.1.3.5-A Disconnecting Barometric Reference



Figure 8.1.3.5-B Barometric Reference Removal

8. Maintenance and Recalibration

8.2 Recalibration

8.2.1 Calibration Services by Mensor or WIKA worldwide

Mensor and WIKA worldwide have extensive experience and knowledge of Mensor products. Calibration of the transducers in these products can be performed at the addresses below or by competent internal or external labs using the procedures in this section.

Table 8.2.1 Service Centers

Service Center USA	Service Center Europe
Mensor website: www.mensor.com tel: 1-512-396-4200 1-800-984-4200 fax: 1-512-396-1820 email: tech.support@mensor.com	WIKA Alexander Wiegand SE & Co. KG website: www.wika.de / www.wika.com tel: (+49) 9372 132-0 fax: (+49) 9372 132-406 email: CTServiceTeam@wika.com

EN

8.2.2 Environment

For maximum accuracy, allow the CPD8500 to warm up a minimum of 15 minutes in ambient temperature within the compensated range prior to a calibration. In addition, the instrument should be at rest on a stable platform that is free of excessive vibration and shock. It is recommended to wait to the specified warm up time of 4 hours after power on prior to performing calibration.

8.2.2.1 Pressure Calibration Setup for CPD8500

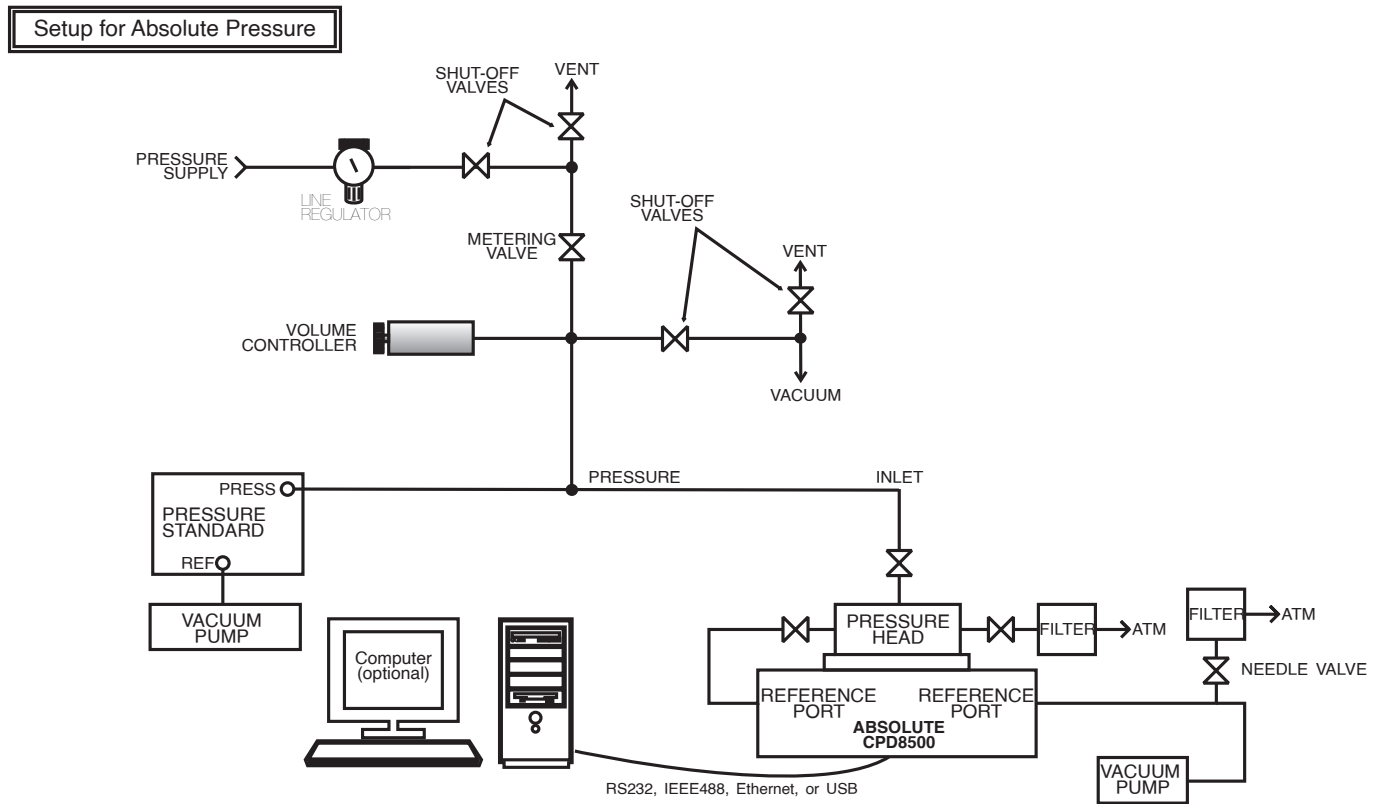

PN 0019408001G 09/2022 EN

8. Maintenance and Recalibration

EN

Setup for Gauge Pressure

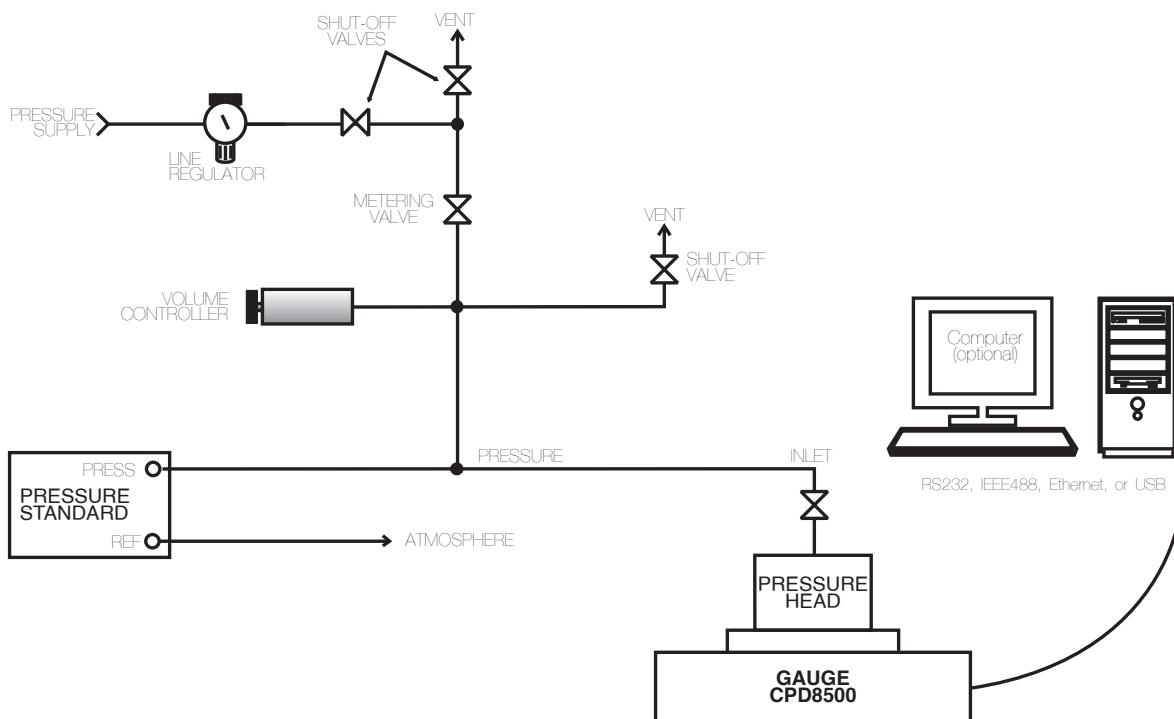

8.2.3 Pressure Standards

Mensor recommends the use of appropriately accurate primary pressure standards when calibrating this instrument. Such standards should be sufficient so that when the techniques of the ISO Guide to the Expression of Uncertainty in Measurement (GUM) are applied, the instrument meets its accuracy statements as required by ISO/IEC 17025:2005, or other applicable standards.

8.2.4 Media



The recommended calibration medium is dry nitrogen or clean dry instrument air for the absolute CPD8500. For the gauge CPD8500, it is recommended to calibrate the measuring head in clean dry air and lubricating the measuring head with recommended lubricating oil mentioned in Section 5.3.2 Gauge Measuring Head. A height variation between the standard and the CPD8500 can cause errors. A calculation should be made to compensate for this difference. This compensation can be done in Section 8.2.8 Head Settings Application.



WARNING!

Before proceeding with calibration on any components inside the CPD8500, it is essential to set the Local Gravity. This is a critical parameter for accurate calibration results. Refer to Section 6.1.1 Power Up for detailed instructions.

8.2.5 Calibration Data

The Calibration Data Application is where the calibration data for each component (measurement head, temperature probe, EMM components, optional internal barometer and the internal vacuum sensor) of the instrument is stored and amended. Each calibration data consists of the serial number (S/N) and Pressure Type (if relevant) can be seen in this screen. The date of calibration can be entered by pressing the corresponding button and entering the date with the keypad. Pressing the Check [] button confirms the date entry. The certificate name and number can be entered by pressing the corresponding button. This opens a alpha numeric keypad. To save the name of the certificate press []. To revert back to the factory calibration, press the “Restore Factory Cal” button. To view the calibration data for each component press the “Select Device” button at the top and choose a component from the resulting selection menu.

8. Maintenance and Recalibration

EN



Figure 8.2.5-A Calibration Data App

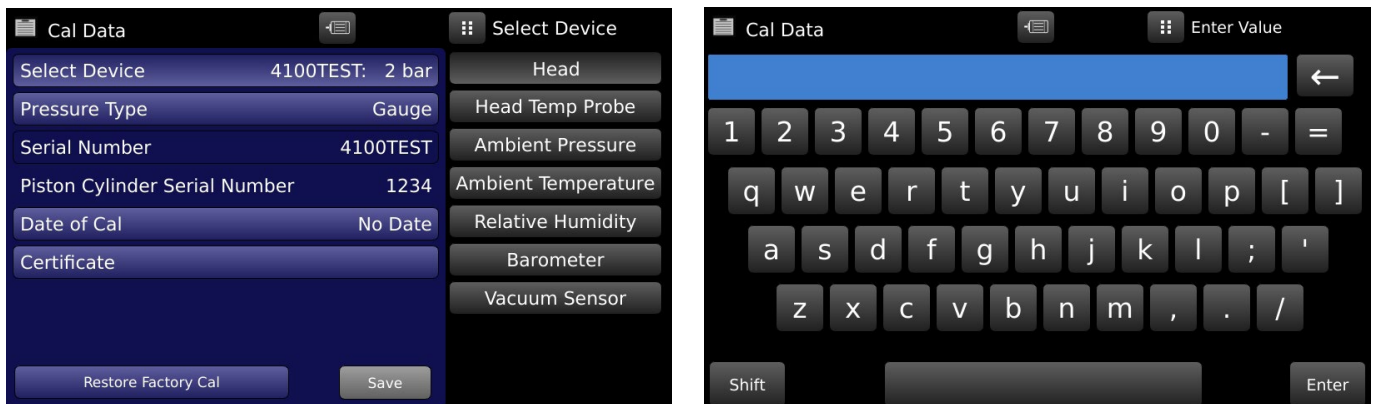



Figure 8.2.5-B Device Selection (left) and Calibration Certificate Name Entry (right)

8.2.6 Calibration Application



The Calibration Application (Figure 8.2.6-A Calibration App) provides a place to adjust or perform the calibration of the different components inside the CPD8500. Depending on the type of component, it provides the user an option to perform a single point, two point or up to eleven point linearization (Figure 8.2.6-B Calibration Selection Menu). Regardless of the calibration sequence, the type of calibration can be either “As Found” or “Live” and can be accessed within the menu of each calibration sequence. The primary screen in the Calibration App allows the selection of the desired component/device (Measuring head, temperature probe, ambient pressure, ambient temperature, ambient humidity, optional internal barometer and the vacuum sensor) by pressing the corresponding line. After the device selection, a selection for calibration sequence is required. At all times within the Calibration App, the current device and the sequence are indicated at the bottom left of the screen. Pressing the Back [] and Next [] buttons exit the current calibration routine and move to the previous or next screen respectively.

8. Maintenance and Recalibration

EN



Figure 8.2.6-A Calibration App

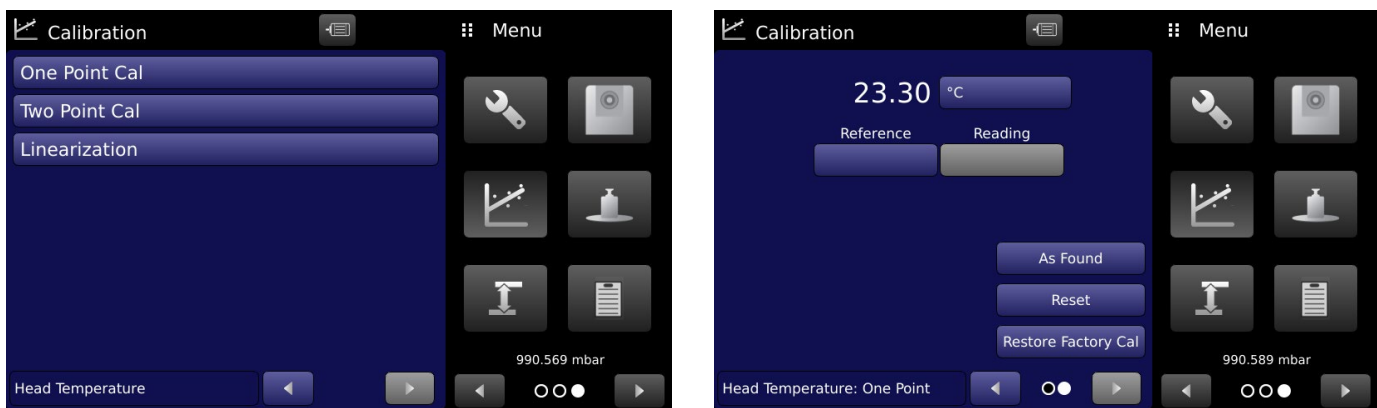

Figure 8.2.6-B Calibration Selection Menu



WARNING!

Performing calibration on different components within the CPD8500 could alter the accuracy of the complete instrument!

8.2.6.1 One Point Calibration

A single point calibration of the selected device/component can be accomplished by pressing “One Point Cal” in the calibration sequence selection screen.

The “As Found” calibration button allows the user to enter a “true” reading from the Reference standard in the “Reference” button and calibrate the device by entering an “as found” reading in the “Reading” button that is within tolerance limits to the Reference value (Figure 8.2.6.1-A). The “Reading” button is grayed out until a value is entered in the “Reference” button.

The “Live” calibration button actively captures the current reading measured by the device and the “Reading” button acts like a label. The calibration is achieved in the “Live” mode by entering the “true” value from the Reference that is within the tolerance limits to the current device value displayed in the “Reading” label. The device specific units can be chosen by clicking the button next to the device reading (Figure 8.2.6.1-B).

The values entered can be reset and restored to factory defaults by pressing the “Reset” button or “Restore Factory Cal” button respectively (Figure 8.2.6.1-C). The calibration can be saved by pressing the “Save” button (Figure 8.2.6.1-D). The tolerance limits

PN 0019408001G 06/2022 EN

8. Maintenance and Recalibration

for various devices/components inside the CPD8500 are mentioned in the Table 8.2.6.1.



Figure 8.2.6.1-A One Point Calibration (As Found)

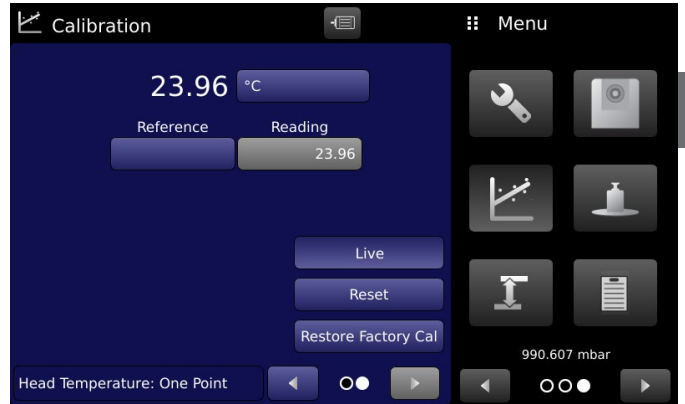

Figure 8.2.6.1-B One Point Cal (Live)



Figure 8.2.6.1-C Restoring Factory Cal



Figure 8.2.6.1-D Saving One Point Calibration

Table 8.2.6.1 Tolerance Limits (One Point Calibration)

Device/Component	Tolerance limit between Reference and Reading
Head temperature probe	+/- 5% of nominal range
Ambient temperature	+/- 5% of nominal range
Ambient pressure	+/- 5% of nominal range
Relative humidity	+/- 5% of nominal range
Internal Barometer	+/- 1% of nominal range
Internal vacuum transducer	+/- 40% of nominal range

8. Maintenance and Recalibration

8.2.6.2 Two Point Calibration

A two point calibration of the selected device/component can be accomplished by pressing “Two Point Cal” in the calibration sequence selection screen. A two point calibration is commonly used to adjust the zero and span (sometimes referred to as the offset and slope) of a device. The device specific units can be chosen by clicking the button next to the device reading. The two point calibration can be done either “As Found” or “Live” mode. The modes can be toggled by pressing the “As Found” button on the screen.



Figure 8.2.6.2 Two Point Cal (As Found)

Follow the steps below for a complete Two Point Calibration:

To calibrate the “Low Point” in “As Found” mode:

- Enter the true reference value for low point by pressing the button under “Reference” next to “Low Point” and using the pop up keyboard to the right of the screen. The allowable range for this value is between first point in the range up to 20% of the span of the current device.
- The button to enter “Reading” is enabled and the adjusted value for device reading can be entered by pressing the “Reading” button next to “Low Point” followed by the check mark []. The Reading value entered must be within the tolerance limits specified in Table 8.2.6.2.

To calibrate the “High point” in “As Found” mode:

- Enter the true reference value for high point by pressing the button under “Reference” next to “High Point” and using the pop up keyboard to the right of the screen. The allowable range for this value is between 80% of the span and full scale value of the of the current device.
- The button to enter “Reading” is enabled and the adjusted value for device reading can be entered by pressing the “Reading” button next to “High Point” followed by the check mark []. The Reading value entered must be within the tolerance limits specified in Table 8.2.6.2.
- After all four values (high reference, high reading, low reference and low reading) have been entered, the Save button will become active. Press the Save button to accept the calibration data and save it to the memory of the device.

To calibrate the “Low Point” in “Live” mode:

- The “Reading” button becomes a label and indicates the current measurement from the active device. Apply necessary pressure, temperature or humidity to allow for a measurement between first point in range up to 20% of the span of the device.
- Enter the true reference value for low point by pressing the button under “Reference” next to “Low Point” and using the pop up keyboard to the right of the screen followed by the check mark []. The allowable range for this value must be within the tolerance values defined in Table 8.2.6.2

To calibrate the “High point” in “Live” mode:

- The “Reading” button indicates the current measurement. Ensure that the measurement is between 80% of the span and full scale value of the of the current device.
- Enter the true reference value for high point by pressing the button under “Reference” next to “High Point” and using the pop up keyboard to the right of the screen followed by the check mark []. The allowable range for this value must be within the tolerance values defined in Table 8.2.6.2.

8. Maintenance and Recalibration

- After all values have been entered, the Save button will become active. Press the Save button to accept the calibration data and save the calibration to the memory of the device.

Table 8.2.6.2 Tolerance Limits (Two Point Calibration)¹

Device/Component	Tolerance limit between Reference and Reading for low point	Tolerance limit between Reference and Reading for high point
Head temperature probe	+/- 5% of nominal range	+/- 10% of nominal range
Ambient temperature	+/- 5% of nominal range	+/- 10% of nominal range
Ambient pressure	+/- 5% of nominal range	+/- 10% of nominal range
Relative humidity	+/- 5% of nominal range	+/- 10% of nominal range
Internal Barometer	+/- 1% of nominal range	+/- 2% of nominal range
Internal vacuum transducer	+/- 40% of nominal range	+/- 40% of nominal range

EN

8.2.6.3 Linearization

The linearization calibration sequence provides a place to record upscale and downscale calibration data and to linearize each device using that data. An “As Found” or “Live” calibration can be performed in either the upscale or upscale and downscale direction using anywhere from three to eleven points across the complete range (Figure 8.2.6.3-A Linearization Settings). The record of the readings from the reference standard and the corresponding reading from the instrument’s device/component can be recorded and transcribed into the linearization Matrix. The menu also allows the user to plot the linearization matrix into a graph for a visual display of the linearity curve of the device. Furthermore, the curve can also be displayed in terms of its segment, slope and intercept information. The Linearization menu pages can be navigated by Next [▶] and Back [◀] buttons to access main settings, linearization table, graph and curve.



Linearization calibration sequence is only available for measuring head, head temperature probe and the internal barometer.

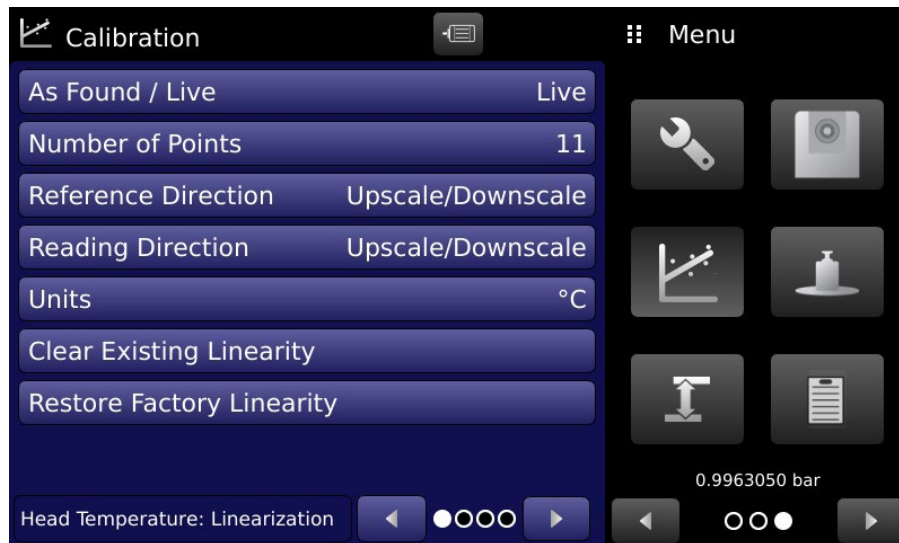

Figure 8.2.6.3-A Linearization Settings

Page one of the linearization sequence provides a place for user to enter the settings for the linearization including type of calibration (As Found/Live), calibration cycles (Upscale/Downscale), number of points (3-11) and units of calibration. The “Pressure Type” button can be toggled between Gauge and Absolute if a pressure device is being linearized. The “Restore Factory Linearity” button overwrites the factory linearity for the active device.

Page two of the linearization sequence is the Linearization Matrix. The menu automatically populates the screen with equidistant increments from low to high values corresponding to the range of the active device. Each value from the reference standard can be entered under the “Reference” column, corresponding upscale and downscale readings from the device can be entered under the

8. Maintenance and Recalibration

respective “Reading” columns.

In “As Found” mode, simply enter the reference & reading values by pressing the number and a keypad will appear where the number can be entered. Press the check mark [] to accept each value. Figure 8.2.6.3-B Linearization Matrix (As Found) shows typical linearity values for the head temperature probe.

EN

In “Live” mode, simply apply the necessary pressure or temperature to reach the nominal linearity point and then add enter the “true” reference value in the corresponding “Reference” cell. Press the check mark [] to accept each value. The values must be within the tolerance limits of each other to be accepted.

The tolerance limits between reference and reading values can be found in Table 8.2.6.3.



Figure 8.2.6.3-B Linearization Matrix (As Found)



WARNING!

Exiting the Linearization Matrix without completing or saving all the values in the matrix results in all changes being lost.

Page three of the linearization sequence displays the Linearization Graph. This gives a visual representation of the errors associated with the values entered in the Linearization Table. This Linearization error graph shows a scaling that corresponds to the maximum error calculated from the data entered in the Linearization Matrix. It is a good indication of the overall error of the device, and will quickly reveal any gross data entry errors that have been made.

When satisfied that all values have been entered correctly, press the “Adjust” button and then the “Save” button to save the new calibration data in the device or instrument memory (Figure 8.2.6.3-C Linearization Graph).

Table 8.2.6.3 Tolerance Limits (Linearization)

Device/Component	Tolerance limit between Reference and Reading
Measuring head	+/- 0.5% of nominal range
Head temperature probe	+/- 1% of nominal range
Internal Barometer	+/- 0.5% of nominal range

8. Maintenance and Recalibration

EN



Figure 8.2.6.3-C Linearization Graph

8.2.7 Mass Calibration Application



The Mass Calibration App (Figure 8.2.7-A) provides a guided menu to calibrate the internal load cell of the CPD8500. An eleven point linearization going upscale and downscale can be performed to the internal load cell to ensure optimum performance through out the span of the instrument. Instructions and status messages to proceed with the calibration are displayed in the right one-fourths of the screen.

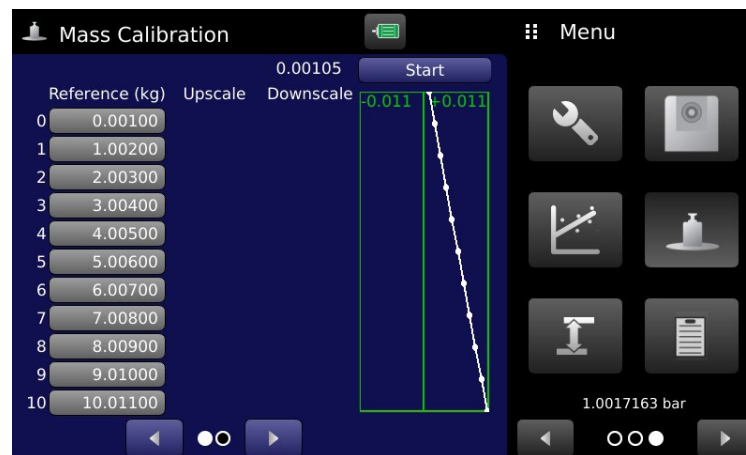

Figure 8.2.7-A Mass Calibration App



The mass calibration requires the use of an external mass set to correspond to the span of the internal load cell. Section 11.7 External Mass Set is the recommended mass set required for this operation.



WARNING!

The instrument must be vented completely with the device under test removed before starting mass calibration. The brushless motor also needs to be removed before the mass platen is installed.

8. Maintenance and Recalibration

To begin calibrating the load cell, simply press “Start” at the top of the display screen. This would change the status of button to “Initialize”. At this stage, remove the measuring head and install the pedestal (Figure 8.2.7-B) included in the external mass set. Once installed, press “Initialize” to allow an internal cycling of the load cell (Figure 8.2.7-C). The progress of each step can be seen on the right one fourth of the screen. After a successful initialization, press “Zero” to perform a zero adjustment on the load cell (Figure 8.2.7-D).

EN

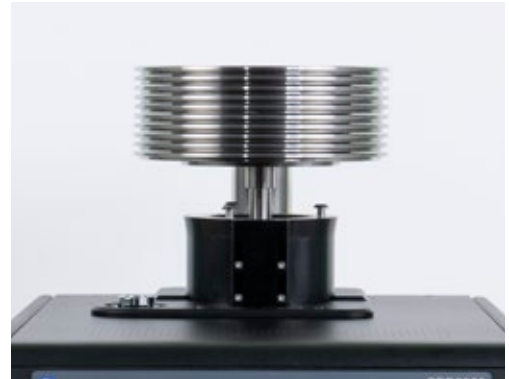
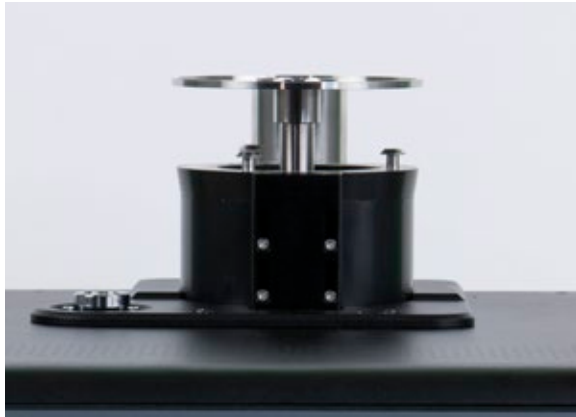

Figure 8.2.7-B Pedestal Installed on Base (left) and External Masses on Base (right)

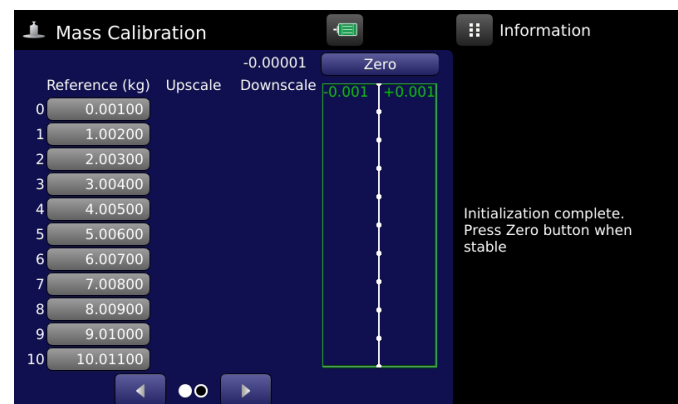
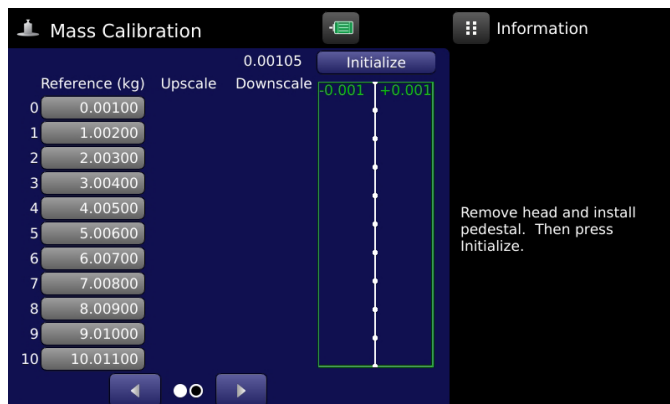

Figure 8.2.7-C Zeroing Load Cell

The “reference” values can now be set as per the calibration certificate of the reference mass set. Alternatively enter the nominal values of each of the masses in the reference mass set using a numeric keypad (Figure 8.2.7-E). Once all the reference values are entered, press “Next” to proceed with the load cell calibration. When prompted, add a 1 Kg (nominal) mass to the pedestal and press the corresponding “Upscale” button when stable (Figure 8.2.7-F). This would record the upscale value corresponding to the reference mass and move the pointer to the next reference mass. After completing the cycle of loading (upscale) and unloading (downscale) the masses, the calibration can be saved by pressing “Save” button (Figure 8.2.7-G).

8. Maintenance and Recalibration

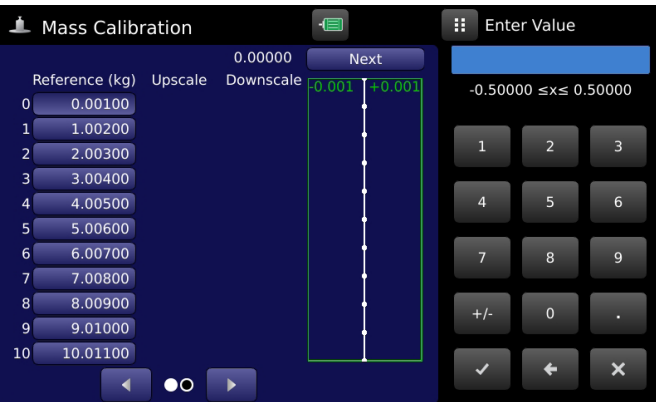

Figure 8.2.7-E Reference Values



Figure 8.2.7-F Upscale Mass Adjustment

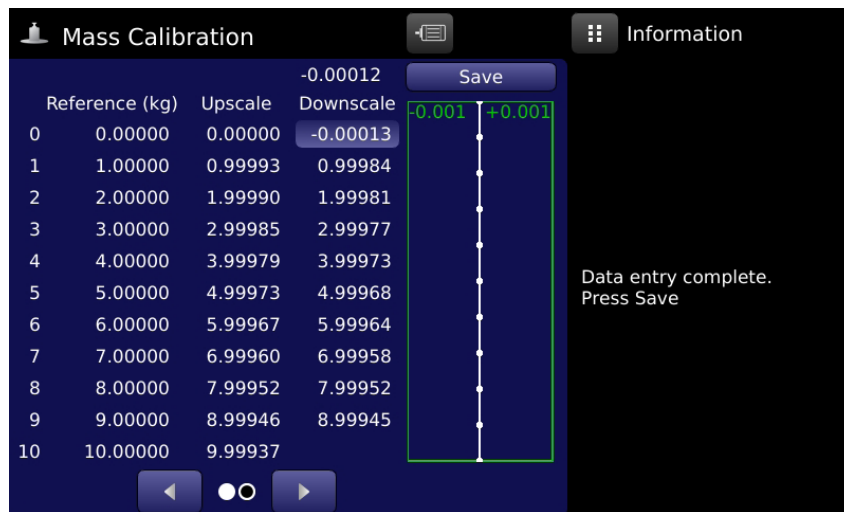
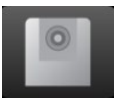



Figure 8.2.7-G Mass Calibration Complete

8.2.8 Head Settings Application



The Head Settings App (Figure 8.2.8-A) provides a place to edit, load and create information for measurement heads that are either new or pre installed with the instrument. The saved heads can be viewed by clicking “Selected Head” and selecting the desired head from the drop down menu. The instrument is capable of saving detailed information for eight different measurement heads. The extended menu can be accessed by pressing the Next Page [] button.

The menu allows editing all the parameters corresponding to an existing measuring head like the head model, serial number, piston/ cylinder serial number, pressure range, Kn units & pressure type, temperature coefficient, mass density, distortion coefficient, drive motor type, limit & speed and local gravity.



WARNING!

Modifying existing measuring head parameters will alter the calibrated accuracy and certification of the measuring head.



Note: Head data files that are not selectable due to restrictions of the base pressure type/head pressure type may still be selected, edited or deleted here.

8. Maintenance and Recalibration

EN

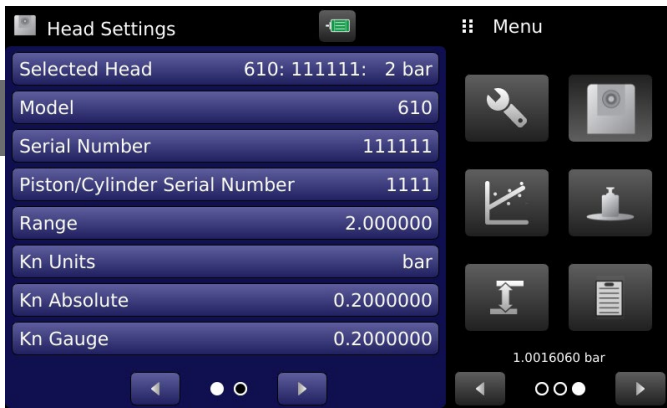



Figure 8.2.8-A Head Settings App

To modify any information of an existing head, simply press on the corresponding parameter button and make a selection from the drop down menu or enter the new values using a keyboard and then pressing the Check mark [] button.

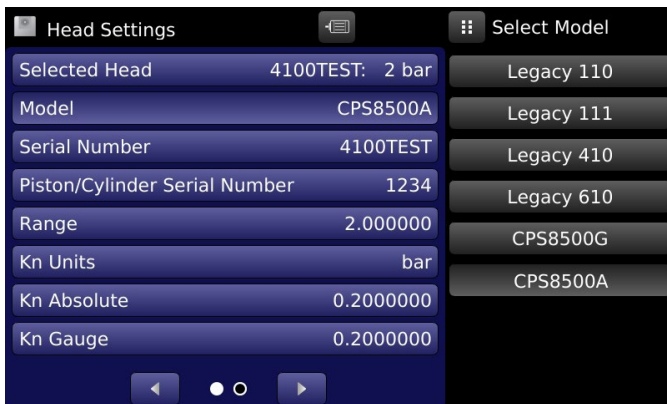

Figure 8.2.8-B Head Parameter Modification-Model (left) and Distortion Coefficient (right)

8. Maintenance and Recalibration

8.2.8.1 New Head Addition



Note: It is advised that the user enters new Measurement Head data through the onboard flash memory switch or using a USB installation as opposed to the Head Settings App. The App should be used when Head Information can not be loaded from the onboard memory or USB.

EN

To add a new Measuring Head to the instrument, simply click the “Selected Head” button and select “Create” in the drop down menu. This modifies the Head Settings App to indicate mandatory parameter entry with the parameter highlighted in red enter the type of the measuring head (Figure 8.2.8.1-A). All the mandatory parameter are located in the the Head Settings App and the information needed to create them can be obtained from either the calibration certificate of the measuring head or the head label. Parameters like the Serial number, Piston/ cylinder serial number, Measurement range, Piston temperature coefficient, P/C mass density and Distortion coefficient can be entered by entering the new value with the numeric keypad while parameters like Model, Kn Units and Motor type are selected from a drop down menu. The Kn Absolute and Gauge are automatically calculated once all the highlighted information is entered. The user can modify these to represent the values calculated in the calibration certificate.

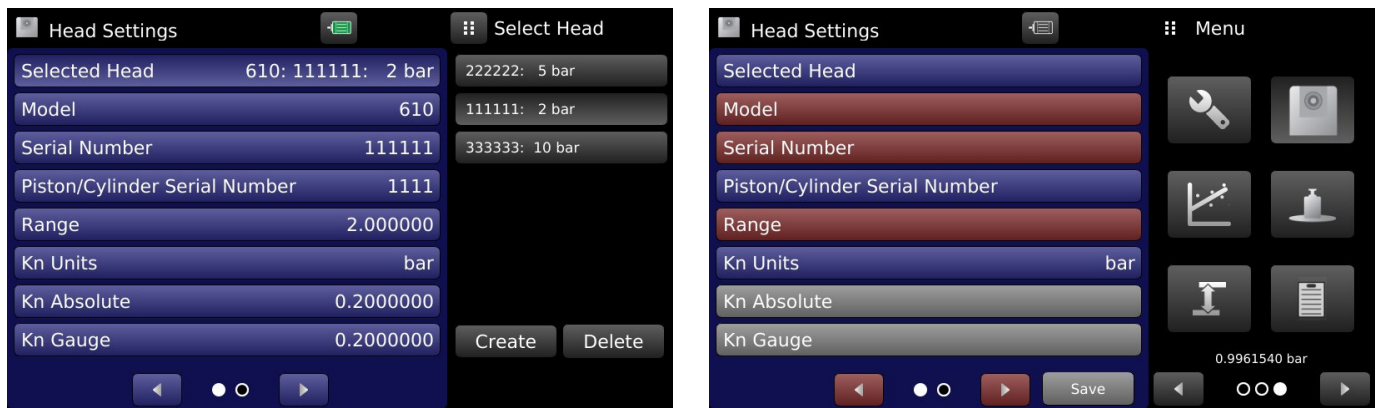

Figure 8.2.8.1-A Head Creation

Once all the necessary information is entered, the Save button becomes active and the head parameters can be saved to the memory of the CPD8500. Pressing the “Save” button prompts “Create new head data file?” on the screen and pressing OK [] button creates the new head file with the above data. (Figure 8.2.8.1-B).



Figure 8.2.8.1-B Save Head File

8. Maintenance and Recalibration

8.2.9 Reference Level

EN



The Reference Level Application provides an automated way to calculate the reference level offset between a device being tested and the CPD8500, based on

- Media (gas) type
- Height: the difference between the device under test and the transducers in the CPD8500
(Difference = DUT - CPD8500)

As an example, if the device under test (DUT) is 10 inches above the CPD8500, enter +10 in “Height” button with the “Imperial” units

- Gas Temperature
- Local Gravity
- Gas Density: the density of the pressure media

The Reference Level application is placed under the password protected area of the operator interface to safeguard against inadvertent activation. It is intended to be used to accurately measure the pressure at an external source that is at a different elevation from the CPD8500 sensing that pressure.

The Reference Level App allows for presets to be saved for pressure medias; nitrogen and dry air with input methods in both imperial and metric units. To enable a preset, simply press the “Nitrogen” or “Dry Air” button.

These four parameters are used to calculate the pressure that is a result of the different elevations. It should not be used when calibrating CPD8500. The Reference Level should be set at zero before calibrating the CPD8500.



The reference level should not be active when calibrating CPD8500. The reference level should be set at zero before calibrating the CPD8500. Difference in height between the laboratory standard and the CPD8500 during calibration should be factored into the uncertainty analysis.

Figure 8.2.9 shows the Reference Level screen. The height, gas temperature, local gravity and gas density can be entered here based on the specific setup of the system.



Figure 8.2.9 Reference Level App (Dry Air)

9. Dismounting, Return and Disposal

EN

9. Dismounting, Return and Disposal



WARNING!

Physical injuries and damage to property and the environment through residual media

Residual media in the dismantled instrument can result in a risk to persons, the environment and equipment.

- ▶ Wear the requisite protective equipment (see Section 3.6 Personal Protective Equipment).
- ▶ Observe the information in the material safety data sheet for the corresponding medium.
- ▶ Wash or clean the dismantled instrument, in order to protect persons and the environment from exposure to residual media.

9.1 Dismounting



WARNING!

Physical injuries and damage to property and the environment through residual media

Upon contact with hazardous media (e.g. oxygen, acetylene, flammable or toxic substances), harmful media (e.g. corrosive, toxic, carcinogenic, radioactive), and also with refrigeration plants and compressors, there is a danger of physical injuries and damage to property and the environment.

- ▶ Before storage of the dismantled instrument (following use) wash or clean it, in order to protect persons and the environment from exposure to residual media.
- ▶ Wear the requisite protective equipment (see Section 3.6 Personal Protective Equipment).
- ▶ Observe the information in the material safety data sheet for the corresponding medium.



WARNING!

Risk of burns

During dismantling there is a risk of dangerously hot media escaping.

- ▶ Let the instrument cool down sufficiently before dismantling it!



DANGER!

Danger to life caused by electric current

Upon contact with live parts, there is a direct danger to life.

- ▶ The dismantling of the instrument may only be carried out by skilled personnel.



WARNING!

Physical injury

When dismantling, there is a danger from aggressive media and high pressures.

- ▶ Wear the requisite protective equipment (see Section 3.6 Personal Protective Equipment).
- ▶ Observe the information in the material safety data sheet for the corresponding medium.
- ▶ Only disconnect the pressure measuring instrument/measuring assembly/test and calibration installations once the system has been depressurized.

9. Dismounting, Return and Disposal

9.2 Return

Strictly observe the following when shipping the instrument:

All instruments delivered to Mensor must be free from any kind of hazardous substances (acids, bases, solutions, etc.) must therefore be cleaned before being returned.

EN



WARNING!

Physical injuries and damage to property and the environment through residual media

Residual media in the dismantled instrument can result in a risk to persons, the environment and equipment.

- ▶ With hazardous substances, include the material safety data sheet for the corresponding medium..

When returning the instrument, use the original packaging or a suitable transport packaging.

To avoid damage:

1. Wrap the instrument in an anti static plastic film.
2. Place the instrument in the same packaging as it arrived. See Section 4. Transport, Packaging and Storage for details.
3. Label the shipment/ carrying case as carriage of a highly sensitive measuring instrument.



Information on returns can be found under the heading "Service" on our local website.

9.3 Disposal

Incorrect disposal can put the environment at risk.

Dispose of instrument components and packaging materials in an environmentally compatible way and in accordance with the country-specific waste disposal regulations.



This marking on the instruments indicates that they must not be disposed of in domestic waste. The disposal is carried out by return to the manufacturer or by the corresponding municipal authorities.

10. Specifications

10. Specifications

Accuracy specifications presented herein are obtained by comparison with primary standards traceable to a national metrology institute or recognized international standard organization. These specifications are obtained in accordance with the ISO Guide to the Expression of Uncertainty in Measurement (GUM). The calibration program at Mensor is accredited by the American Association of Laboratory Accreditation (A2LA) as complying with both the ISO/IEC 17025:2005 and the ANSI/NC SL Z540-1-1994 standards. If there is an exception to the requirements and recommendations of Z540 during a calibration the exception is noted on the individual calibration certificate.

Mensor reserves the right to change specifications without notice.

10.1 Measuring Head

Measuring head including the piston cylinder system model CPS8500		
Pressure range	Piston cylinder system Kn ¹⁾	Lubrication media
Absolute pressure		
0 ... 2 bar (0 ... 29 psi)	0.2 bar / kg (2.9 psi / kg)	Dry, clean air or nitrogen
0 ... 5 bar (0 ... 72.5 psi)	0.5 bar / kg (7.25 psi / kg)	
0 ... 10 bar (0 ... 145 psi)	1 bar / kg (14.5 psi / kg)	
0 ... 20 bar (0 ... 290 psi)	2 bar / kg (29 psi / kg)	
Gauge pressure		
0 ... 1 bar (0 ... 14.5 psi)	0.1 bar / kg (1.45 psi / kg)	Dry, clean air or nitrogen
0 ... 2 bar (0 ... 29 psi)	0.2 bar / kg (2.9 psi / kg)	
0 ... 5 bar (0 ... 72.5 psi)	0.5 bar / kg (7.25 psi / kg)	
0 ... 10 bar (0 ... 145 psi)	1 bar / kg (14.5 psi / kg)	Dry, clean air or nitrogen over Drosera oil
0 ... 20 bar (0 ... 290 psi)	2 bar / kg (29 psi / kg)	Dry, clean air or nitrogen over Sebacate oil
0 ... 50 bar (0 ... 725 psi)	5 bar / kg (72.5 psi / kg)	
0 ... 100 bar (0 ... 1,450 psi)	10 bar / kg (145 psi / kg)	
0 ... 200 bar (0 ... 2,900 psi)	20 bar / kg (290 psi / kg)	
0 ... 500 bar (0 ... 7,250 psi)	50 bar / kg (725 psi / kg)	
Calibration interval	5 years	
Permissible pressure		
Permissible pressure media	Dry, clean air or nitrogen (ISO 8573-1:2010 class 5.5.4 or better)	
Maximum pressure	100% FS of the measuring head	
Connections		
Pressure port adapters (0 ... 2 bar abs. & 0 ... 5 bar abs.)	Standard: KF16 flange; Standard with coalescing filter: 1/8" NPT female	
Pressure port adapters (Gauge & 0 ... 10 bar abs., 0 ... 20 bar abs.)	Standard: 7/16-20 SAE female	
Wetted parts	2017 AL, 2024 AL, 303 SS, 304 SS, 316 SS, Tungsten Carbide, Sapphire, Buna N, FKM/ FPM, Silicone grease, Drosera oil, Sebacate oil, Urethane	
Filter elements (0 ... 2 bar abs. & 0 ... 5 bar abs.)	Pressure ports: 20 micron filters to prevent contamination Vacuum/vent ports: External 0.01 micron coalescing filter to prevent contamination when venting vacuum	

1) Kn is defined as the piston cylinder coefficient determining the pressure generated per kilogram of mass exerted on the CPD8500 chassis.

10. Specifications

10.2 Base Instrument

Base instrument

EN

Instrument

Instrument version	Desktop case
Dimensions	See technical drawings
Weight	Absolute: approx. 23.5 kg (52 lbs) incl. all internal options without measuring head Gauge: approx. 15 kg (33 lbs) incl. all internal options without measuring head
Warm-up time	Up to 4 hours to rated accuracy

Display

Screen	7.0" color LCD with resistive touchscreen
Resolution	5 ... 8 digits depending on range and units

Connections

Pressure connections (Reference port/ Vacuum port)	Absolute: 2 ports with KF16 flanges
Barometer port adapters	10-32 UNF port with 5/32 barb fitting
Wetted parts	2017 AL, 2024 AL, 304 SS, 316 SS, Nickel, Buna N, FKM/ FPM, Silicone grease, Christo Lube MCG 1030, Urethane, PCTFE

Permissible pressure

Reference port/ Vacuum port	2 Pa ... 100 kPa abs. (15 mTorr ... 750 Torr abs.)
-----------------------------	--

Voltage supply

Power supply	AC 100 ... 120 V, 50/60 Hz; AC 220 ... 240 V, 50/60 Hz
Power consumption	max. 50 VA

Permissible ambient conditions

Storage temperature	-20 ... 70 °C (-4 ... 158 °F)
Humidity	5 ... 95% r. h. (relative humidity non-condensing)
Compensated temperature range	15 ... 40 °C (59 ... 104 °F)
Mounting position	Horizontal
Altitude	max. 3,048 meters
Shock/ Vibration	max. 2 G

Environmental monitoring module & Head temperature

Sensor	Range	Accuracy ²⁾
Head temperature sensor	0 ... 50 °C (32 ... 122 °F)	0.5 °C
Ambient temperature sensor	-40 ... 125 °C (- 40 ... 257 °F)	1.0 °C
Relative humidity sensor	0 ... 100%	5% of relative humidity
Ambient pressure sensor	552 ... 1,170 mbar abs (8 ... 17 psi abs)	2% of reading
Calibration interval	2 years	

Residual vacuum

Sensor	Range	Accuracy ²⁾
High accuracy vacuum sensor	0.1 ... 1000 mtorr	0.8% of reading
Calibration interval	2 years	

Communication

Interface	Standard: Ethernet, IEEE-488, USB, RS-232.
Command sets	Mensor and CPD8000
Response time	approx. 100 ms

PN 0019408001G 06/2022 EN

10. Specifications

Total System Accuracy	
Standard accuracy ^{2) 3)}	50 ppm ⁵⁾
Premium accuracy ^{4) 6)}	35 ppm (compatible only with absolute and gauge CPS8500 up to 20 bar/290 psi)
Calibration interval	50 ppm: 2 years, 35ppm: 1 year

EN

- 2) Accuracy is defined by the total measurement uncertainty, with the coverage factor (k = 2) and includes the intrinsic performance of the instrument, the measurement uncertainty of the reference instrument, long-term stability, influence of ambient conditions, drift and temperature effects over the compensated range with recommended zero point adjustment on power up.
- 3) Standard accuracy: Between 0 ... 25% of the full scale, the accuracy is 50 ppm of tenth of full scale value and between 25 ... 100% of the full scale, the accuracy is 50 ppm / 0.005% of reading
- 4) Premium accuracy: Between 0 ... 25% of the full scale, the accuracy is 35 ppm of tenth of full scale value and between 25 ... 100% of the full scale, the accuracy is 35 ppm / 0.0035% of reading
- 5) PPM = parts per million of the reading.
- 6) 35 ppm accuracy is warranted on a matched pair of CPS8500 and CPD8500 and the pair must be calibrated together

10.3 Approvals and Certificates

Approvals and certificates	
EC declaration of conformity	
EMC directive ⁸⁾	EN 61326-1 emission (group 1, class A) and interference immunity (industrial application)
Low voltage directive	EN 61010-1
RoHS directive	2011/65/EU, article 4
Certificate	
Calibration ⁹⁾	Standard: A2LA calibration certificate (standard on factory) Optional: DKD/DAkkS calibration certificate

- 8) **Warning!** This is class A equipment for emissions and is intended for use in industrial environments. In other environments, e.g. residential or commercial installations, it can interfere with other equipment under certain conditions. In such circumstances the operator is expected to take the appropriate measures.
- 9) Calibration in a horizontal position/operating position.

10. Specifications

10.4 Dimensions in mm (in)

10.4.1 Absolute

EN

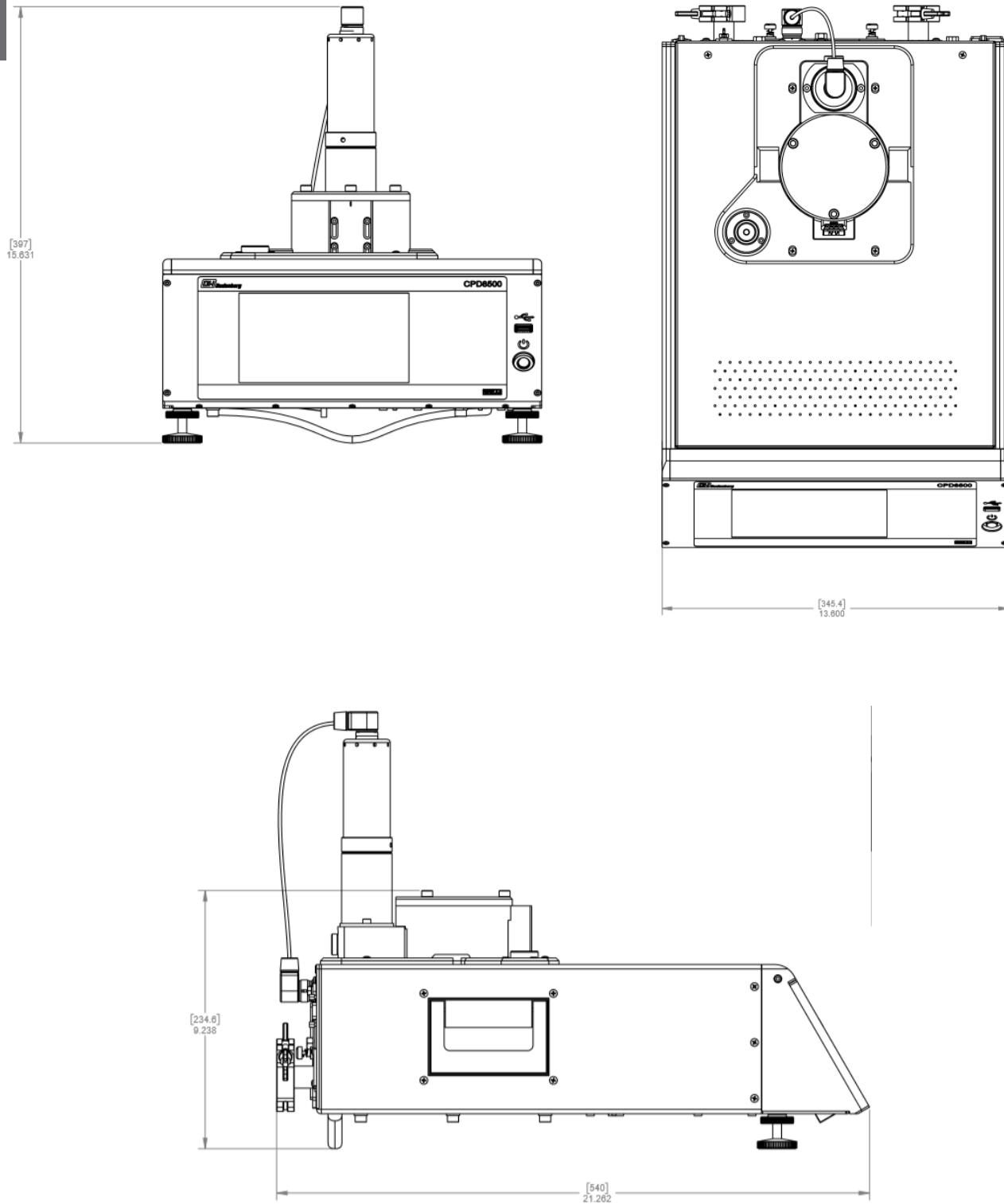

10. Specifications

10.4.2 Gauge

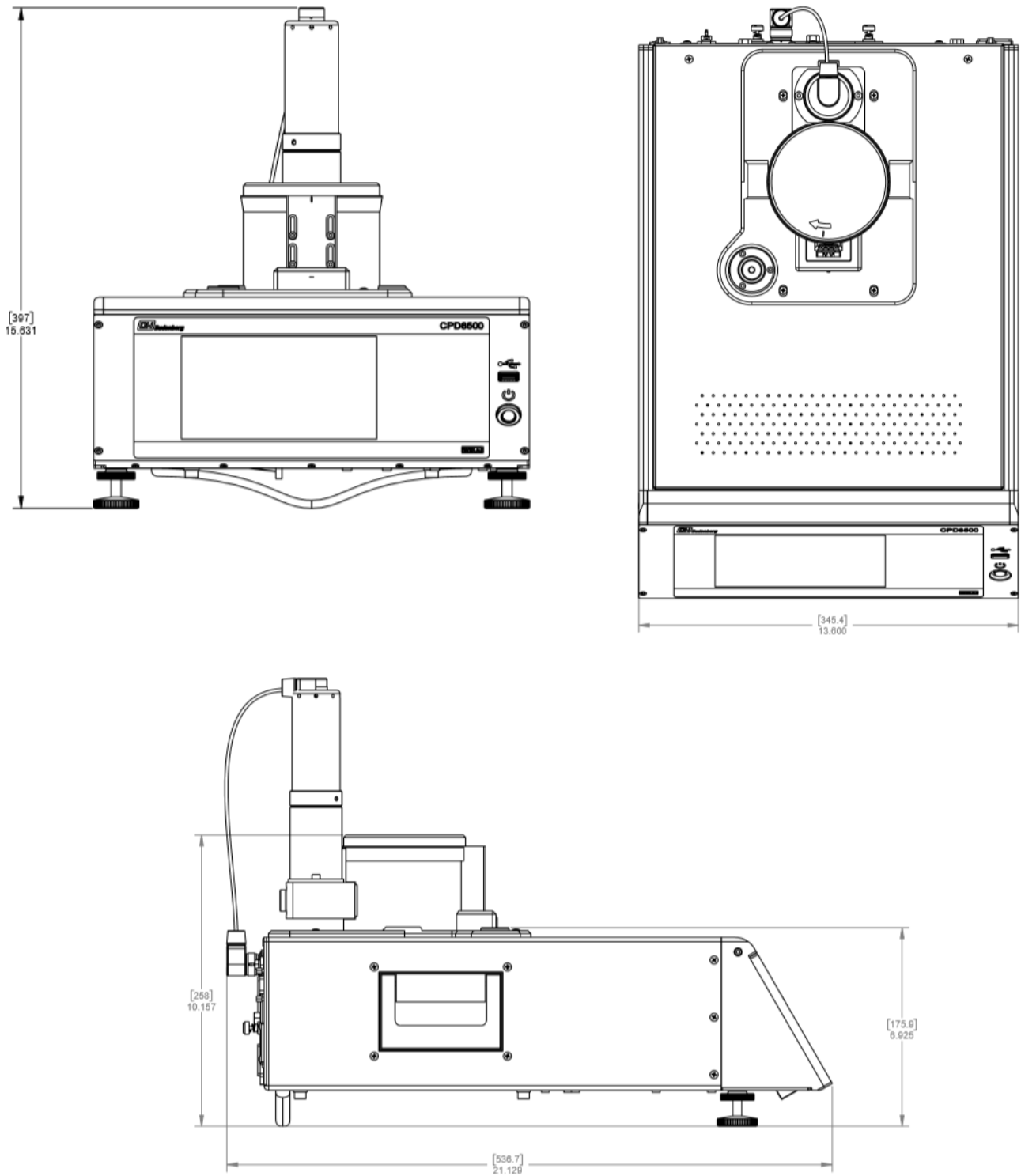

EN

PN 0019408001G 09/2022 EN

11. Accessories

11. Accessories

- Barometric reference sensor (for pressure emulation)
- Vacuum transducer
- Absolute accessory kit
- Vacuum pump requirements
- Gauge accessory kit
- Upgrade accessory kit
- External mass set
- EMM calibration sled
- Barometric reference calibration sled

EN

11.1 Barometric Reference Sensor

The CPD8500 can be ordered with an internal barometric reference sensor. It is a very stable, absolute pressure transducer, used to accurately measure local atmospheric pressure. It is used to display the barometric pressure (reading appears on the bottom right side of the display) or as a barometric reference for bidirectional emulation. The barometric reference sensor is installed inside the CPD8500 base.

11.1.1 Bidirectional Pressure Emulation

In the Home Application (main screen) a gauge instrument will indicate “Gauge” in the Pressure Type button (this is the default mode). When the Pressure Type button is pressed a selection screen will appear to choose between Absolute, Bidirectional and Gauge. If bidirectional is chosen, the button turns yellow. This change in color is an indication that the instrument is in emulation mode. This change in color is an indication that the instrument is in emulation mode.

In the absolute emulation mode the atmospheric pressure reading from the barometric reference transducer is added to the gauge pressure reading of the instrument to emulate an absolute pressure. The instrument is only able to emulate absolute pressures above atmospheric pressure. Sub-atmospheric measurement is not possible.

11.1.2 Emulation Mode Accuracy

The accuracy in emulation mode is different than native mode.

The barometric reference has six significant digits and has a guaranteed drift of 0.0000041 psi over a 24 hour period.

The absolute uncertainty of the barometric reference must be considered in the bidirectional pressure uncertainty.

11.1.3 Barometric Reference Calibration

The Barometric Reference Transducer can be calibrated in exactly the same manner as the other installed components as described in Section 8.2 Recalibration. Alternatively the barometric reference can be calibrated outside of the instrument using a calibration sled or adapter (Section 11.9 Barometric Reference Calibration Sled).

11.2 Vacuum Transducer

The vacuum transducer is installed inside the absolute CPD8500 base. The vacuum transducer is used inside the instrument to measure residual pressure inside the reference chamber, when performing absolute mode measurements. The vacuum transducer is a highly stable vacuum transducer which enables performing a Zero calibration on the absolute CPD8500. Figure 11.2 shows the vacuum transducer outside the instrument.



Figure 11.2 Vacuum Transducer

11.3 Absolute Accessory Kit

The CPD8500 Absolute base accepts two styles of absolute heads: low pressure (1-5 bar) and high pressure (10-20 bar). The low pressure heads feature three KF-16 flanges which are used to connect to vacuum, vent, and working pressure, and the high pressure heads feature a DH1500 port. The accessories included with a CPD8500 Absolute base contain the necessary components to adapting any of these heads (Figure 11.3). This accessory kit includes the following components:

- Pressure fittings
 - ⇒ 3 way ball valve with 1/4" tube kit
 - ⇒ 7/16"-20 SAE to KF-16
 - ⇒ Pushrod
- Vacuum components
 - ⇒ 3x Sintered Filter KF-16 Centering Rings
 - ⇒ 7x Standard KF-16 Centering Rings
 - ⇒ 3x KF-16 Plug Discs
 - ⇒ 10x KF-16 Clamps
 - ⇒ 3x Vacuum Valves
 - ⇒ 0.5m KF-16 Flexible Hose
 - ⇒ 1.0m KF-16 Flexible Hose
 - ⇒ KF-16 Elbow
 - ⇒ KF-16 Tee
- Vacuum metering kit
 - ⇒ KF-16/NPT Tee
 - ⇒ 1/4" NPT Male to Female Fitting
 - ⇒ Metering Valve kit
- Vent filter kit
 - ⇒ Coalescing Filter
 - ⇒ KF-16 to 1/8" NPT Male adapter
 - ⇒ Breather Vent Filter
- Tools
 - ⇒ 3/16" hex ball driver
 - ⇒ 1/2" to 9/16" Wrench
 - ⇒ 5mm T-handle Hex Driver
- Miscellaneous
 - ⇒ Loaded USB Drive
 - ⇒ Silicone Tubing for Calibration of Environmental Measuring Module
 - ⇒ Push rod
 - ⇒ Gentle bar soap
 - ⇒ Mensor logo gloves

Pressure fittings are included to adapt an absolute head to a customer's system as needed. Vacuum Components are common to both measuring heads. KF-16 centering rings with sintered filters are recommended for use near the head connections to prevent contamination of the piston-cylinder assembly. The Vacuum Metering Kit is included to allow fine control of vacuum pressure. A reference pressure of less than 2 Pa can often result in device malfunction. The Vent Filter Kit is included to vent the head pressure to atmospheric pressure through a fine coalescing filter to prevent contamination. .

The 5mm hex driver is for installing and removing measuring heads and the protective cover which prevents contamination when no head is installed.

The push rod is used to mate the load cell with the PCA in the measuring head. Section 5.3.2 Absolute Measuring Head explains the installation. The gentle bar soap is used to lightly clean the piston-cylinder assembly (Section 8.1.2 Measuring Head Cleaning).

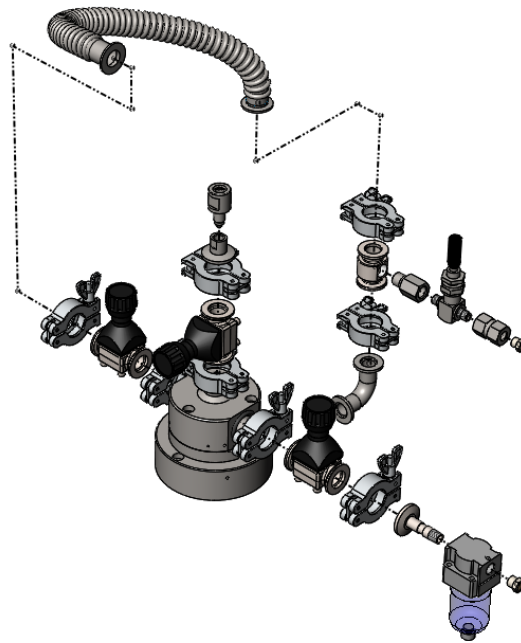

Figure 11.3-A Absolute Accessories Mounted on a Legacy 610 Head

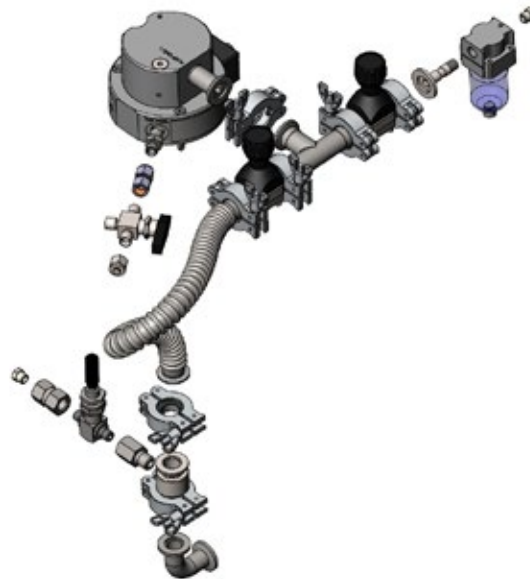

Figure 11.3-B Absolute accessories mounted on CPS8500A 1-5 bar range

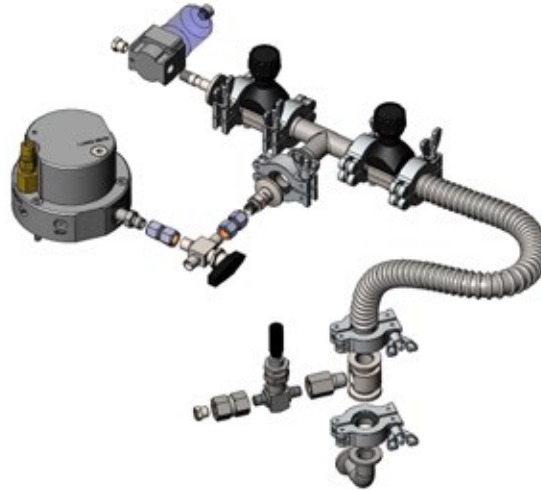

Figure 11.3-C Absolute accessories mounted to CPS8500A 10-20 bar range

11.4 Vacuum Pump Requirements

The vacuum pump used to supply vacuum supply to the absolute CPD8500 must have the following specifications. The vacuum pump is not supplied with the product.

Vacuum Pump	
Displacement (CFM)	Between 3.6 and 7
Ultimate Vacuum (Torr)	Between 0.0005 and 0.0015
Fittings	KF16 flange

11.5 Gauge Accessory Kit

The CPD8500 gauge base requires the following accessories to perform with the gauge measuring heads:

- Pressure fittings
 - ⇒ The appropriate pressure fittings will be supplied with the CPS8500G
- Tools
 - ⇒ 1/2" to 9/16" open end wrench
 - ⇒ 3/16" hex driver
 - ⇒ 3mm Hex Driver
- Miscellaneous
 - ⇒ Loaded USB Drive
 - ⇒ Silicone Tubing for Calibration of Environmental Measuring Module
 - ⇒ Push rod
 - ⇒ Mensor logo gloves

The 3mm hex driver is for installing and removing the protective cap which prevents contamination when no head is installed. The 1/2" to 9/16" wrench is for the fittings that will go on the CPS8500G. The push rod is used to mate the load cell with the PCA in the measuring head. Section 5.3.5 Gauge Measuring Head explains the installation.

11.6 Upgrade Accessory Kit

When upgrading an existing CPD8000 to a new CPD8500, the new absolute instrument requires a few accessories that are different than the accessories being used for the CPD8000:

- Pressure fittings

11. Accessories

EN

- ⇒ The pressure fittings will be supplied with any CPS8500A
- Vacuum components
 - ⇒ 3x Sintered Filter KF-16 Centering Rings
- Tools
 - ⇒ 1/2" to 9/16" open end wrench
 - ⇒ 3/16" hex ball driver
 - ⇒ 5mm T-handle Hex Driver
- Miscellaneous
 - ⇒ Loaded USB Drive
 - ⇒ Silicone Tubing for Calibration of Environmental Measuring Module
 - ⇒ Push rod

The 5mm hex driver is for installing and removing the protective cap which prevents contamination when no head is installed. KF-16 centering rings with sintered filters are recommended for use near the head connections to prevent contamination of the piston-cylinder assembly.

11.7 External Mass Set

An External Mass Set is required to calibrate and linearize the internal load cell to the CPD8500 (See Section 8.2.7 Mass Calibration Application for details). The mass set (Figure 11.7) contains the following:

- Mounting connector
- Pedestal
- 10 x 1 Kg masses
- Mensor logo gloves

The mounting connector mates the internal load cell to the external masses and the pedestal. The mounting connector is installed directly on the push rod on top of the instrument to transfer the weight of the masses on to the load cell. The pedestal is required to provide a support to the individual masses. Then simply follow the instructions in Section 8.2.7 Mass Calibration Application to linearize the load cell.



Figure 11.7 External Mass Set in Carrying Case

11.8 EMM Calibration Sled

The Environmental Monitoring Module (EMM) can be calibrated both inside and outside the instrument. For detailed instructions on calibrating the EMM inside CPD8500, follow instructions in Section 8.2.6 Calibration Application.

To calibrate the EMM outside the CPD8500, a calibration sled or adapter is required for the EMM to communicate with a computer.

PN 0019408001G 06/2022 EN

11. Accessories

The primary function of the calibration sled is to allow communication of the sled via RS-232 port. The calibration can be done by reading the EMM remotely by the PC and comparing the values of each sub component with the reference standard. The calibration sled also requires a 12 V DC power source.



Figure 11.6 EMM Calibration Sled

The calibration sled software along with detailed instructions on setup and calibration can be found on the Mensor website.

11.9 Barometric Reference Calibration Sled

The Barometric Reference Calibration Sled Kit is available to provide a way to calibrate the barometric reference remotely. Calibration of the Barometric Reference can be performed remotely using the Cal sled, a PC and the software provided.



Figure 11.9 Barometric Reference Calibration Sled

12. Appendix

12. Appendix

12.1 Measurement Units

Table 12.1 Measurement Units (unitno)

EN

Code	Description	Output Format
1	pounds per square inch	psi
2	inches of mercury @ 0°C	in Hg 0°C
3	inches of mercury @ 60°F	in Hg 60°F
4	inches of water @ 4°C	in H2O 4°C
5	inches of water @ 20°C	in H2O 20°C
6	inches of water @ 60°F	in H2O 60°F
7	feet of water @ 4°C	ft H2O 4°C
8	feet of water @ 20°C	ft H2O 20°C
9	feet of water @ 60°F	ft H2O 60°F
10	millitorr	mTorr
11	inches of seawater @ 0°C 3.5% salinity	in SW
12	feet of seawater @ 0°C 3.5% salinity	ft SW
13	atmospheres	atm
14	bars	bar
15	millibars	mbar
16	millimeters of water @ 4°C	mm H2O 4°C
17	centimeters of water @ 4°C	cm H2O 4°C
18	meters of water @ 4°C	m H2O 4°C
19	millimeters of mercury @ 0°C	mm Hg 0°C
20	centimeters of mercury @ 0°C	cm Hg 0°C
21	torr	Torr
22	kilopascals	kPa
23	pascals	Pa
24	dyne per square centimeter	dyn/cm2
25	grams per square centimeter	g/cm2
26	kilograms per square centimeter	kg/cm2
27	meters of seawater @ 0°C 3.5% salinity	m SW
28	ounce per square inch	osi
29	pounds per square foot	pfs
30	tons per square foot	tsf
31	percent of full scale	% of Range
32	micron of mercury @ 0°C	mHg
33	ton per square inch	tsi
34	meters of mercury @ 0°C	MHg
35	hectopascals	hPa
36	megapascals	MPa
37	millimeters of water @ 20°C	mm H2O 20°C
38	centimeter of water @ 20°C	cm H2O 20°C
39	meters of water @ 20°C	m H2O 20°C
n/a	User Units 1	User defined
n/a	User Units 2	User defined

PN 0019408001G 06/2022 EN

12. Appendix

12.2 Conversion Factors, PSI

The values listed in the column "To convert from PSI" are the values imbedded in the instrument program. The values listed under "To convert to PSI" are internally calculated approximations based on the imbedded values.

Table 12.2 Conversion Factors, PSI

Code	Pressure Unit	To convert from PSI	To convert to PSI
1	PSI	1	1
2	inHg 0°C	2.036020	0.4911544
3	inHg 60°F	2.041772	0.4897707
4	inH2O 4°C	27.68067	0.03612629
5	inH2O 20°C	27.72977	0.03606233
6	inH2O 60°F	27.70759	0.03609119
7	ftH2O 4°C	2.306726	0.4335149
8	ftH2O 20°C	2.310814	0.4327480
9	ftH2O 60°F	2.308966	0.4330943
10	mTorr	51715.08	0.00001933672
11	inSW 0°C 3.5% salinity	26.92334	0.03714250
12	ftSW 0°C 3.5% salinity	2.243611	0.445710
13	ATM	0.06804596	14.69595
14	Bar	0.06894757	14.50377
15	mBar	68.94757	0.01450377
16	mmH2O 4°C	703.0890	0.001422295
17	cmH2O 4°C	70.30890	0.01422295
18	MH2O 4°C	0.7030890	1.422295
19	mmHg 0°C	51.71508	0.01933672
20	cmHg 0°C	5.171508	0.1933672
21	Torr	51.71508	0.01933672
22	kPa	6.894757	0.1450377
23	PA	6894.757	0.0001450377
24	Dy/cm2	68947.57	0.00001450377
25	gm/cm2	70.30697	0.01422334
26	kg/cm2	0.07030697	14.22334
27	MSW 0°C 3.5% salinity	0.6838528	1.462303
28	OSI	16	0.0625
29	PSF	144	0.006944444
30	TSF	0.072	13.88889
32	μHg 0°C	51715.08	0.00001933672
33	TSI	0.0005	2000
34	mHg 0°C	0.05171508	19.33672
35	hPa	68.94757	0.01450377
36	MPa	0.006894757	145.0377
37	mmH2O 20°C	704.336	0.001419777
38	cmH2O 20°C	70.4336	0.01419777
39	MH2O 20°C	0.704336	1.419777

EN

12. Appendix

12.3 Conversion Factors, Millitorr

The following table lists factors which should be used as multipliers when converting other pressure units to or from millitorr.

Table 12.3 Conversion Factors, Millitorr

EN	Code	Pressure Unit	To convert from millitorr	To convert to millitorr
	1	PSI	0.0001933672	51715.08
	2	inHg 0°C	0.00003936995	25400.08909
	3	inHg 60°F	0.00003948117	25328.53093
	4	inH2O 4°C	0.0005352534	1868.273977
	5	inH2O 20°C	0.0005362028	1864.966281
	6	inH2O 60°F	0.0005357739	1866.458778
	7	ftH2O 4°C	0.00004460451	22419.25773
	8	ftH2O 20°C	0.00004468356	22379.59744
	9	ftH2O 60°F	0.00004464783	22397.50637
	10	mTorr	1.0	1.000000000
	11	inSW 0°C 3.5% salinity	0.0005206091	1920.827359
	12	ftSW 0°C 3.5% salinity	0.00004338408	23049.92831
	13	ATM	0.000001315786	760002.2299
	14	Bar	0.000001333220	750063.6259
	15	mBar	0.001333220	750.0636259
	16	mmH2O 4°C	0.0135954	73.5540997
	17	cmH2O 4°C	0.001359544	735.5409971
	18	MH2O 4°C	0.00001359544	73554.09971
	19	mmHg 0°C	0.001	1000.000000
	20	cmHg 0°C	0.0001	10000.00000
	21	Torr	0.001	1000.000000
	22	kPa	0.0001333220	7500.636259
	23	PA	0.1333220	7.500636259
	24	Dy/cm2	1.333220	0.750063626
	25	gm/cm2	0.001359506	735.561166
	26	kg/cm2	0.000001359506	735561.166
	27	MSW 0°C 3.5% salinity	0.00001322347	75623.11663
	28	OSI	0.0003093875	3232.1992
	29	PSF	0.002784488	359.132477
	30	TSF	0.000001392244	718265.0575
	32	μHg 0°C	1.0	1.000000000
	33	TSI	0.0000000966836	103430160.00
	34	mHg	0.000001	1000000.00
	35	hPa	0.001333220	750.0636259
	36	MPa	0.0000001333220	7500636.259
	37	mmH2O 20°C	0.01361955	73.42388114
	38	cmH2O 20°C	0.001361955	734.2388114
	39	MH2O 20°C	0.00001361955	73423.88114

12. Appendix

12.4 Conversion Factors, Pascal

The following table lists factors which should be used as multipliers when converting other pressure units to or from Pascal.

Table 12.4 Conversion Factors, Pascal

Unit No.	Pressure Unit	To convert from Pascal	To convert to Pascal
1	PSI	1.450377E-04	6.894757E+03
2	inHg 0°C	2.952997E-04	3.386390E+03
3	inHg 60°F	2.961339E-04	3.376850E+03
4	inH2O 4°C	4.014741E-03	2.490820E+02
5	inH2O 20°C	4.021862E-03	2.486410E+02
6	inH2O 60°F	4.018645E-03	2.488400E+02
7	ftH2O 4°C	3.345622E-04	2.988980E+03
8	ftH2O 20°C	3.351551E-04	2.983692E+03
9	ftH2O 60°F	3.348871E-04	2.986080E+03
10	mTorr	7.500636E+00	1.333220E-01
11	inSW 0°C 3.5% sal	3.904899E-03	2.560885E+02
12	ftSW 0°C 3.5% sal	3.254082E-04	3.073062E+03
13	ATM	9.869230E-06	1.013250E+05
14	Bar	1.00000E-05	1.00000E+05
15	mBar	1.00000E-02	1.00000E+02
16	mmH2O 4°C	1.019744E-01	9.806378E+00
17	cmH2O 4°C	1.019744E-02	9.806378E+01
18	MH2O 4°C	1.019744E-04	9.806378E+03
19	mmHg 0°C	7.500636E-03	1.333220E+02
20	cmHg 0°C	7.500636E-04	1.333220E+03
21	Torr	7.500636E-03	1.333220E+02
22	kPa	1.00000E-03	1.00000E+03
23	PA	1.00000E+00	1.00000E+00
24	Dy/cm2	1.00000E+01	1.00000E-01
25	gm/cm2	1.019716E-02	9.806647E+01
26	kg/cm2	1.019716E-05	9.806647E+04
27	MSW 0°C 3.5% sal	9.918444E-05	1.008222E+04
28	OSI	2.320603E-03	4.309223E+02
29	PSF	2.088543E-02	4.788025E+01
30	TSF	1.044271E-05	9.576052E+04
32	μHg 0°C	7.500636E+00	1.333220E-01
33	TSI	7.251885E-08	1.378951E+07
34	mHg 0°C	7.500636E-06	1.333220E+05
35	hPa	1.00000E-02	1.00000E+02
36	MPa	1.00000E-06	1.00000E+06
37	mmH2O 20°C	1.021553E-01	9.789017E+00
38	cmH2O 20°C	1.021553E-02	9.789017E+01
39	MH2O 20°C	1.021553E-04	9.789017E+03

EN

WIKA subsidiaries worldwide can be found online at www.wika.com.



Mensor Corporation
201 Barnes Drive
San Marcos, TX 78666 • USA
Tel. (+1) 512 3964200-15
Fax (+1) 512 3961820
E-Mail sales@mensor.com
www.mensor.com



WIKAI Alexander Wiegand SE & Co. KG
Alexander-Wiegand-Straße 30
63911 Klingenberg • Germany
Tel. +49 9372 132-0
Fax +49 9372 132-406
info@wika.de
www.wika.de